



City Of Richmond, Virginia
Office of the City Clerk

Request to Withdraw Legislation

Paper Number: 2014-266

Chief Patron: Mayor Dwight C. Jones

Introduction Date: 12.8.14

Chief Patron Signature: 

For Office Use Only

Attestation: 

Effective Date: December 29, 2014



CHRISTIAN & BARTON, LLP
ATTORNEYS AT LAW

CHRISTOPHER M. GILL
Direct Dial: 804.697.4114
Direct Fax: 804.697.6114
E-mail: cgill@cblaw.com

December 12, 2014

VIA E-MAIL AND HAND DELIVERY

Matthew J. Ebinger, AICP
Senior Planner
Land Use Administration
Department of Planning and Development Review
City of Richmond
900 East Broad Street, Room 511
Richmond, Virginia 23219

*RE: Withdrawal of Special Use Permit Application for 535 West Broad Street
Parcel No. W0000259004; File No. 9743*

Dear Mr. Ebinger:

On behalf of Mid-Atlantic Commercial Properties, LLC, the applicant under the above referenced application for Special Use Permit (the "Application"), the applicant wishes to inform you that it does not wish to proceed with and hereby withdraws the Application. Should you have any additional questions or comments, please do not hesitate to call me at 697-4114. Thank you and other City staff for your efforts with respect to this Application. The applicant and I look forward to working with you on other projects in the future.

With best regards, I remain

Very truly yours,

Christopher M. Gill

cc: George A. Morgan, III
Derek H. Hoselton, Esq.

CHRISTIAN & BARTON, LLP

Mathew J. Ebinger, AICP
December 12, 2014
Page 2

bcc: Jeffrey P. Geiger, Esq.

1680891

INTRODUCED: December 8, 2014

AN ORDINANCE No. 2014-266

To authorize the special use of the property known as 535 West Broad Street for the purposes of the construction and operation of a building for retail use, with an accessory drive-up window and off-street parking, upon certain terms and conditions.

Patron – Mayor Jones (By Request)

Approved as to form and legality
by the City Attorney

PUBLIC HEARING: JAN 12 2015 AT 6 P.M.

WHEREAS, the owner of the property known as 535 West Broad Street, which is situated in a B-4 Central Business District, desires to use such property for the purposes of the construction and operation of a building for retail use, with an accessory drive-up window and off-street parking, which use, among other things, is not currently allowed by section 114.440.1 of the Code of the City of Richmond (2004), as amended; and

WHEREAS, in accordance with section 17.11 of the Charter of the City of Richmond (2010), as amended, it has been made to appear that, if granted subject to the terms and conditions set forth in this ordinance, the special use granted by this ordinance will not be detrimental to the safety, health, morals and general welfare of the community involved, will not

AYES: _____ NOES: _____ ABSTAIN: _____

ADOPTED: _____ REJECTED: _____ STRICKEN: _____

tend to create congestion in streets, roads, alleys and other public ways and places in the area involved, will not create hazards from fire, panic or other dangers, will not tend to overcrowding of land and cause an undue concentration of population, will not adversely affect or interfere with public or private schools, parks, playgrounds, water supplies, sewage disposal, transportation or other public requirements, conveniences and improvements, and will not interfere with adequate light and air; and

WHEREAS, (i) the City Planning Commission has conducted a public hearing to investigate the circumstances and conditions upon which the Council is empowered to authorize such use, (ii) the City Planning Commission has reported to the Council the results of such public hearing and investigation and its recommendations with respect thereto, and (iii) the Council has conducted a public hearing on this ordinance at which the person in interest and all other persons have had an opportunity to be heard;

NOW, THEREFORE,

THE CITY OF RICHMOND HEREBY ORDAINS:

§ 1. **Finding.** Pursuant to section 114-1050.1 of the Code of the City of Richmond (2004), as amended, the Council hereby finds that the special use set forth in and subject to the terms and conditions of this ordinance will not (i) be detrimental to the safety, health, morals and general welfare of the community involved, (ii) tend to create congestion in streets, roads, alleys and other public ways and places in the area involved, (iii) create hazards from fire, panic or other dangers, (iv) tend to overcrowding of land and cause an undue concentration of population, (v) adversely affect or interfere with public or private schools, parks, playgrounds, water supplies, sewage disposal, transportation or other public requirements, conveniences and improvements, or (vi) interfere with adequate light and air.

§ 2. **Grant of Special Use Permit.**

(a) Subject to the terms and conditions set forth in this ordinance, the property known as 535 West Broad Street and identified as Tax Parcel No. W000-0259/004 in the 2014 records of the City Assessor, being more particularly shown on a survey entitled “ALTA/ACSM Land Title Survey of 0.608 Acres of Land Known as 535 W. Broad Street, City of Richmond, Virginia,” prepared by Halder Surveys, P.C., and dated February 4, 2014, a copy of which is attached to and made a part of this ordinance, hereinafter referred to as “the Property,” is hereby permitted to be used for the purposes of the construction and operation of a building for retail use, with an accessory drive-up window and off-street parking, hereinafter referred to as “the Special Use,” substantially as shown on the plans entitled “535 W. Broad St.,” prepared by Blakeway Corp, dated June 5, 2014, and last revised November 6, 2014; the plans entitled “Walgreens Broad St. and Belvidere St.,” prepared by Barry Byrd Architecture, and dated November 7, 2014; and the plans entitled “Walgreens West Broad Street & North Belvidere Street Store No.,” prepared by Barry Byrd Architecture, dated May 20, 2014, and last revised November 10, 2014, all hereinafter referred to as “the Plans,” copies of which are attached to and made a part of this ordinance.

(b) The adoption of this ordinance shall constitute the issuance of a special use permit for the Property. The special use permit shall inure to the benefit of the owner or owners of the fee simple title to the Property as of the date on which this ordinance is adopted and their successors in fee simple title, all of which are hereinafter referred to as “the Owner.” The conditions contained in this ordinance shall be binding on the Owner.

§ 3. **Special Terms and Conditions.** This special use permit is conditioned on the following special terms and conditions:

(a) The Special Use of the Property shall include a building for retail use, substantially as shown on the Plans, with an accessory drive-up window, and no more than 19 off-street surface parking spaces, substantially as shown on the Plans or as otherwise approved by the Director of Planning and Development Review.

(b) Signage on the Property shall be limited to one freestanding sign, no greater than six feet in height and containing an area not to exceed 24 square feet, and wall signage not to exceed an aggregate area of 160 square feet, all substantially as shown on the Plans. All signage shall utilize reverse channel lit lettering and reverse channel lit graphics, as shown on the Plans, and the use of LED signage shall be prohibited.

(c) Window glazing of the Belvidere elevation, as identified on the Plans, shall consist of clear glazing and glazing with non-commercial graphics or display windows, substantially as shown on the Plans. The glazing with non-commercial graphics and display windows shall be approved separately by the Director of Planning and Development Review. Window glazing of the parking area elevation, as identified on the Plans, shall consist of frosted glazing and clear glazing, substantially as shown on the Plans. Window glazing of the Broad Street elevation, as identified on the Plans, shall consist of clear glazing, substantially as shown on the Plans. Reflective or spandrel glazing shall not be permitted.

(d) Site lighting height shall be limited to a maximum of 23 feet, substantially as shown on the Plans.

(e) All building materials, material colors, site improvements, and landscaping shall be substantially as shown on the Plans, subject to the provisions of any applicable Old and Historic District regulations and any approvals granted by the Commission of Architectural Review.

(f) Direct pedestrian access to the building shall be provided from both Belvidere Street and Broad Street, substantially as shown on the Plans.

(g) In addition to the abovementioned retail use, other principal and accessory uses permitted in the B-4 Central Business District also shall be permitted on the Property without an amendment to the special use permit granted by this ordinance, provided that (i) height requirements applicable in the B-4 Central Business District are not exceeded, (ii) all underlying zoning requirements pertaining to such other principal and accessory uses in the B-4 Central Business District are complied with and (iii) a Plan of Development pertaining to such other principal and accessory uses is approved by the Director of Planning and Development Review.

§ 4. **Supplemental Terms and Conditions.** This special use permit is conditioned on the following supplemental terms and conditions:

(a) All required final grading and drainage plans, together with all easements made necessary by such plans, shall be approved by the Director of Public Utilities prior to the issuance of building permits.

(b) Storm or surface water shall not be allowed to accumulate on the land. The Owner, at its sole cost and expense, shall provide and maintain at all times adequate facilities for the drainage of storm or surface water from the Property so as not to adversely affect or damage any other property or public streets and the use thereof.

(c) Facilities for the collection of refuse shall be provided in accordance with the requirements of the Director of Public Works. Such facilities shall be located or screened so as not to be visible from adjacent properties and public streets.

(d) Any encroachments existing, proposed on the Plans or contemplated in the future shall require separate authorization and shall be subject to the applicable provisions of the Code of the City of Richmond (2004), as amended, and all future amendments to such laws.

(e) The Owner shall make improvements, in the form of the installation of two street trees, within the right-of-way substantially as shown on the Plans, which improvements may be completed in one or more phases as approved by the Director of Public Works. All improvements and work within the public right-of-way shall be (i) completed in accordance with the requirements of the Director of Public Works, (ii) considered completed only upon written confirmation by the Director of Public Works that such improvements and work are in accordance with such requirements, (iii) transferred to the City, following the written confirmation by the Director of Public Works, pursuant to a transfer of interest document approved as to form by the City Attorney and accepted by the Chief Administrative Officer or the designee thereof on behalf of the City. The Chief Administrative Officer or the designee thereof, for and on behalf of the City, is hereby authorized to accept, in the manner for which this subsection provides, all improvements and work required by and meeting the requirements of this subsection. The final certificate of occupancy shall not be issued for the Property until all requirements of this subsection are fully satisfied.

(f) In all other respects, the use of the Property shall be in accordance with the applicable underlying zoning regulations.

§ 5. **General Terms and Conditions.** This special use permit is conditioned on the following general terms and conditions:

(a) No permit implementing this special use permit shall be approved until satisfactory evidence has been presented to the Zoning Administrator that any delinquent real estate taxes applicable to the Property have been paid.

(b) The Owner shall be bound by, shall observe and shall comply with all other laws, ordinances, rules and regulations applicable to the Property, except as otherwise expressly provided in this ordinance.

(c) Words and phrases used in this ordinance shall be interpreted to have the meanings ascribed to them by section 114-1220 of the Code of the City of Richmond (2004), as amended, unless the context clearly indicates that a different meaning is intended.

(d) Notwithstanding any other provision of law, this special use permit is being approved due, in part, to the mitigating effects of each and every condition attached hereto; consequently, if any portion of this ordinance is determined to be invalid for any reason by a final, non-appealable order of any Virginia or federal court of competent jurisdiction, the invalidity shall cause the entire ordinance to be void and of no further effect from the effective date of such order.

(e) The privileges granted by this ordinance may be revoked pursuant to the provisions of sections 114-1050.7 through 114-1050.11 of the Code of the City of Richmond (2004), as amended, and all future amendments to such laws. Failure to comply with the terms and conditions of this ordinance shall constitute a violation of section 114-1080 of the Code of the City of Richmond (2004), as amended, and all future amendments to such law, or any other applicable laws or regulations.

(f) When the privileges granted by this ordinance terminate and the special use permit granted hereby becomes null and void, whether as a result of the Owner relinquishing this

special use permit in a writing addressed to the Director of Planning and Development Review or otherwise, use of the Property shall be governed thereafter by the zoning regulations prescribed for the district in which the Property is then situated.

§ 6. **Implementation.** The Commissioner of Buildings is authorized to issue a building permit substantially in accordance with the Plans for the Special Use subject to the terms and conditions set forth in this ordinance. An application for the building permit shall be made within 730 calendar days following the date on which this ordinance becomes effective. If either the application for the building permit is not made within the time period stated in the previous sentence or the building permit terminates under any provision of the Virginia Statewide Building Code, this ordinance and the special use permit granted hereby shall terminate and become null and void.

§ 7. **Effective Date.** This ordinance shall be in force and effect upon adoption.



City of Richmond

900 East Broad Street
Richmond, VA 23219
www.Richmondgov.com

Item Request
File Number: TMP-733

O & R REQUEST

NOV 13 2014

RECEIVED
NOV 24 2014

O & R Request

OFFICE OF CITY ATTORNEY

Chief Administration Office
City of Richmond

RECEIVED
EDITION: 1 NOV 18 2014
Mayor's Office City of Richmond

DATE: November 7, 2014
TO: The Honorable Members of City Council
THROUGH: Dwight C. Jones, Mayor *[Signature]*
(This in no way reflects a recommendation on behalf of the Mayor)
THROUGH: Christopher L. Beschler, Interim Chief Administrative Officer *[Signature]*
THROUGH: Peter L. Downey, Jr., Interim Deputy Chief Administrative Officer
FROM: Mark A. Olinger, Director of Planning and Development Review *[Signature]*

To authorize the special use of the property known as 535 West Broad Street for the purposes of the construction and operation of a building for retail use, with an accessory drive-up window and off-street parking, upon certain terms and conditions.

ORD. OR RES. No. _____

PURPOSE: To authorize the special use of the property known as 535 West Broad Street for the purposes of the construction and operation of a building for retail use, with an accessory drive-up window and off-street parking, upon certain terms and conditions.

REASON: The subject property is located in the B-4 Central Business District which does not permit drive-up windows in conjunction with a retail use. The applicant has therefore requested a special use permit to authorize a retail pharmacy with drive-up window.

RECOMMENDATION: In accordance with the requirements of the City Charter and the Zoning Ordinance, the City Planning Commission will review this request and make a recommendation to City Council. This item will be scheduled for consideration by the Commission once it has been introduced to City Council. A letter outlining the Commission's recommendation will be forwarded to City Council following that meeting.

BACKGROUND: The subject property consists of a 0.6 acre parcel at the southwest corner of W. Broad Street and N. Belvidere Street, in the Monroe Ward neighborhood. The site is improved with an automobile fueling station and is located across N. Belvidere Street from the site of the future VCU

Institute for Contemporary Art.

The property is located within the Broad Street City Old & Historic District and is a part of the B-4 Central Business Zoning District running along the Broad Street corridor in the area. A mix of commercial, office, institutional, mixed-use, multi-family, and single- and two-family land uses are present in the area.

The applicant is proposing to remove the existing automobile fueling station and redevelop the site with a new building containing a retail pharmacy with drive-up window and off-street parking. This concept has been submitted to the Commission of Architectural Review. The applicant is also contemplating future residential use of the property in addition to the retail use.

According to the Richmond Downtown Plan, the subject property falls within the Urban Center Area. Such areas are "characterized by higher density, mixed-use development, typically arranged on a fine-grained street network, with wide sidewalks, regular tree planting, and minimal setbacks." Moreover, the Urban Center Area demonstrates "a dense mix of office space, apartments, and retail located in four to six-story brick buildings that front the street. Pedestrians have an active presence in these neighborhoods" (pp. 3.25-3.26).

In regards to Broad Street, the Downtown Plan states: "Pedestrian interest is held by requiring all buildings to front the sidewalk with a human-scaled, public façade. An active, street-level frontage, such as retail, should be encouraged, with large display windows attracting pedestrians to the district. It is imperative that off-street parking, whether parking lots or structured parking garages, be placed at the center of the block and lined with habitable buildings. All new construction and liner buildings should relate to the historic buildings along Broad Street. New buildings should respect the height and scale of historic buildings and respond to their level of architectural detail, in particular their pattern of window and door openings" (p. 4.7).

"As Broad Street redevelops and new businesses begin to fill its storefronts and office space, it is important that a careful mix of neighborhood convenience and other retail/service is accommodated in the district. Buildings should be mixed-use, with retail on the ground floor and residences or offices above. This will allow Downtown residents to live comfortably and accomplish errands close to home, while regional shoppers will support destination boutiques and unique restaurants" (p. 4.8). A General Recommendation for the subject property and adjacent parcels along W. Broad Street is the development of an internal parking garage with buildings lining N. Belvidere and W. Broad Streets (p. 4.6).

FISCAL IMPACT: The Department Planning and Development Review does not anticipate any impact to the City's budget for this or future fiscal years.

COST TO CITY: Staff time for processing the request; preparation of draft ordinance; and publishing, mailing and posting of public notices.

BUDGET AMENDMENT NECESSARY: No.

REVENUE TO CITY: \$1,800.00

DESIRED EFFECTIVE DATE: Upon Adoption.

REQUESTED INTRODUCTION DATE: December 8, 2014

CITY COUNCIL PUBLIC HEARING DATE: January 12, 2015

REQUESTED AGENDA: Consent.

RECOMMENDED COUNCIL COMMITTEE: None.

CONSIDERATION BY OTHER GOVERNMENTAL ENTITIES: City Planning Commission, January 5, 2015

AFFECTED AGENCIES: Office of Chief Administrative Officer
Law Department (for review of draft ordinance)
City Assessor (for preparation of mailing labels for public notices)

RELATIONSHIP TO EXISTING ORD. OR RES.: None.

REQUIRED CHANGES TO WORK PROGRAM(S): None.

ATTACHMENTS: Draft Ordinance, Application Form, Applicant's Report, Plans & Survey

STAFF: Matthew J. Ebinger, Senior Planner
Land Use Administration (Room 511)
804-646-6308

DCD O&R No. 14-47

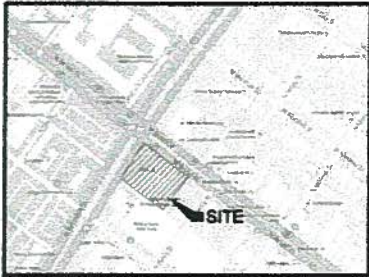

VICINITY MAP

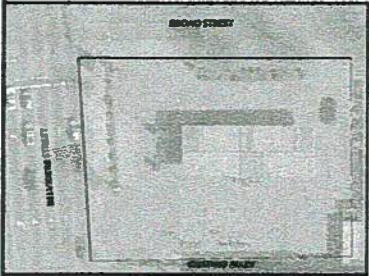

AERIAL MAP

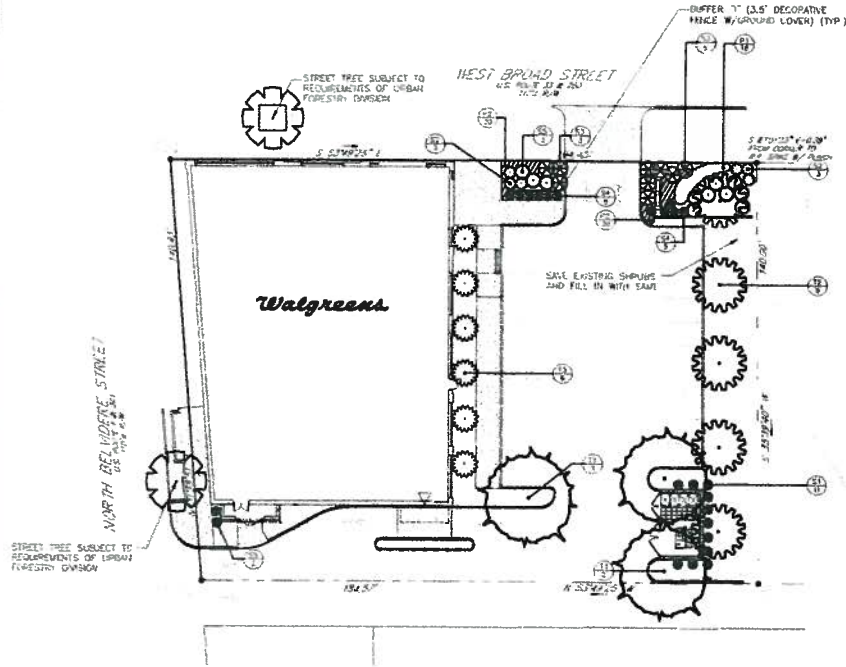

WALGREENS @ 535 W. BROAD ST.

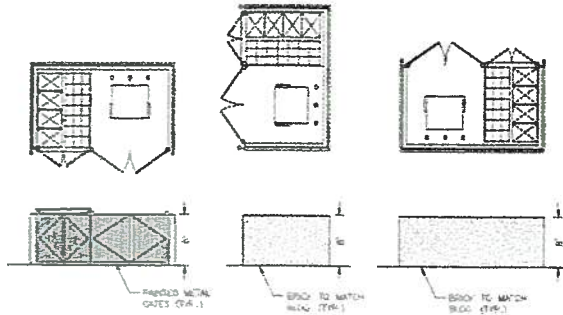

DUMPSTER ENCLOSURE DETAILS

PLANT KEY			
KEY	QTY.	BOTANICAL NAME COMMON NAME	MAXIMUM SIZE NOTES
T1	3	Ginkgo biloba 'Autumn Gold' AUTUMN GOLD GINKGO	2 1/2 - 3" CAL. SINGLE LEADER
T2	8	Ilex x attenuata 'Posner' FOSTER'S HOLLY	6 - 8' HT. FULL
T3	6	Lagerstroemia 'Catawba' CATAWBA CRAPE MYRTLE	8 - 10' HT. SPECIMEN MATCHING
B1	11	Claytonia Japonica JAPANESE CLEYERA	34 - 30" HT. 3" O.C.
B2	8	Cupressus sempervirens ITALIAN CYPRESS	34 - 30" HT. 3" O.C.
B3	8	Juniperus chinensis 'Procumbens Nana' JAPANESE GARDEN JUNIPER	16 - 18" SPRD. 3" O.C.
B4	11	Hamamelis virginica 'Gulf Stream' GULF STREAM HAMMILLA	16 - 18" HT. 3" O.C. NOT 'Mona Purpurea'
B5	13	Raphanobrassica canadensis 'Minor' DWARF YERBOO INDIAN HAWTHORN	18 - 24" SPRD. 3" O.C.
P1	18	Engelhardtia amygdaloides 'Robusta' ROBUST SPURGE	1 GAL. 18" O.C.
P2	66	Liriodendron muscari 'Variegata' VARIEGATED LIRIODEN	1 GAL. MIN. 5 BBS 18" O.C.

TREE COVERAGE CALCULATIONS		
# PARKING SPACES	20	
MULTIPLIER	X 40	
TREE COVERAGE REQUIRED	800	
QTY./TREE SPECIES/SIZE		
4/AUTUMN GOLD GINKGO/2 1/2 - 3" CAL.	CREDIT/TREE TOTAL CREDIT	
160	460	
6/CATAWBA CRAPE MYRTLE/8 - 10' HT.	40	240
8/FOSTER'S HOLLY/8 - 8' HT.	60	250
TOTAL TREE COVERAGE PROVIDED		
940		

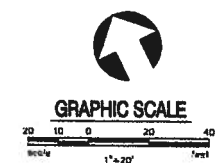

Blakeway Corp.
Landscape Architecture

PROJECT: WALGREENS @ 535 W. BROAD ST.
DATE: 11/15/17
SCALE: AS SHOWN

535 W. BROAD ST.
PRELIMINARY LANDSCAPE PLAN
DATE: 11/15/17
SCALE: AS SHOWN

D
CONCEPT PLAN

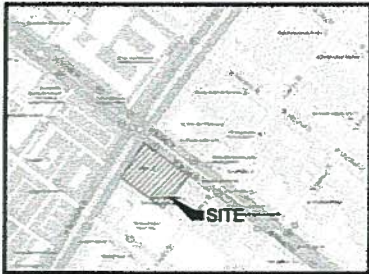

VICINITY MAP

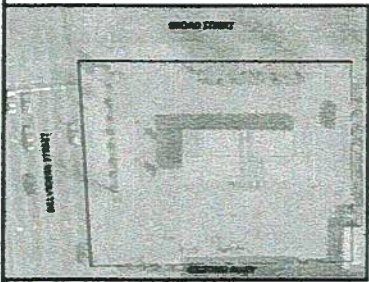

AERIAL MAP

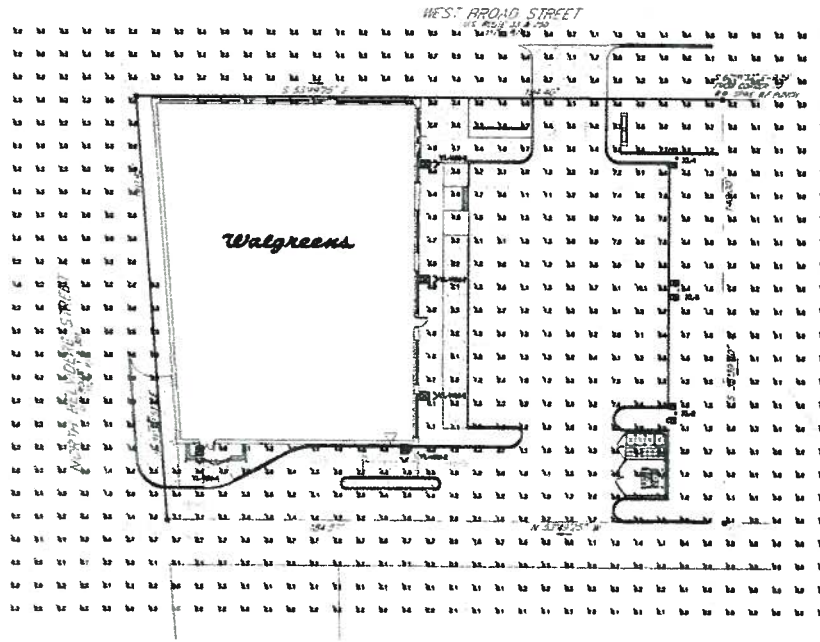

WALGREENS @ 535 W. BROAD ST.

Lot	Area	Volume	Height	Area	Volume	Height	Area	Volume	Height
1	10,000	100,000	10	10,000	100,000	10	10,000	100,000	10
2	10,000	100,000	10	10,000	100,000	10	10,000	100,000	10
3	10,000	100,000	10	10,000	100,000	10	10,000	100,000	10
4	10,000	100,000	10	10,000	100,000	10	10,000	100,000	10
5	10,000	100,000	10	10,000	100,000	10	10,000	100,000	10
6	10,000	100,000	10	10,000	100,000	10	10,000	100,000	10
7	10,000	100,000	10	10,000	100,000	10	10,000	100,000	10
8	10,000	100,000	10	10,000	100,000	10	10,000	100,000	10
9	10,000	100,000	10	10,000	100,000	10	10,000	100,000	10
10	10,000	100,000	10	10,000	100,000	10	10,000	100,000	10

Area	Volume	Height	Area	Volume	Height
1	10,000	100,000	10	10,000	100,000
2	10,000	100,000	10	10,000	100,000
3	10,000	100,000	10	10,000	100,000
4	10,000	100,000	10	10,000	100,000
5	10,000	100,000	10	10,000	100,000
6	10,000	100,000	10	10,000	100,000
7	10,000	100,000	10	10,000	100,000
8	10,000	100,000	10	10,000	100,000
9	10,000	100,000	10	10,000	100,000
10	10,000	100,000	10	10,000	100,000

System	Label	Quantity	Manufacturer	Catalog Number	Description	Lamp	Number Lamps	Footcandle	Lumens Per Lamp	Light Loss Factor	Wattage
XL	XL	3	Libraire Lighting	DSX1 LED 600 1000 40K T 8W 4VOLT HS	DSX1 LED WITH (2) 30 LED LIGHT ENGINE, TYPE T8W OPTIC, 4000K @ 1000mA WITH HOUSE SIDE SHIELD	LED	1	DSX1_LED_3 DC_1000_40 K_T8W_MVO LT_HS_3w	12908.13	0.95	418
YL-WM	YL-WM	5	Libraire Lighting	DSX1 LED 400 1000 40K T8W 4VOLT HS	DSX1 LED WITH (2) 30 LED LIGHT ENGINE, TYPE T8W OPTIC, 4000K @ 1000mA	LED	1	DSX1_LED_4 DC_1000_40 K_T8W_MVO LT_HS	12387.27	0.95	130
XL	XL	0	Libraire Lighting	DSX1 LED 600 1000 40K T8W 4VOLT HS	DSX1 LED WITH (2) 30 LED LIGHT ENGINE, TYPE T8W OPTIC, 4000K @ 1000mA WITH HOUSE SIDE SHIELD	LED	1	DSX1_LED_6 DC_1000_40 K_T8W_MVO LT_HS_3w	12908.13	0.95	200

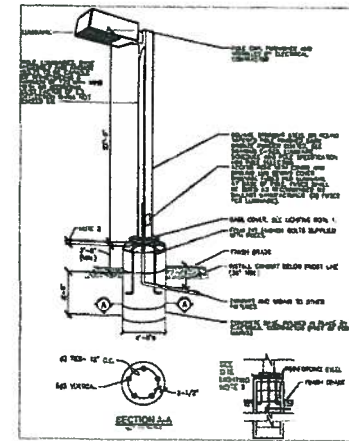

D-Series Size 1

Specifications:

- Beam Spread: 10°
- Mounting Height: 10'-0"
- Beam Spread at 10'-0": 10'-0"
- Beam Spread at 20'-0": 20'-0"
- Beam Spread at 30'-0": 30'-0"
- Beam Spread at 40'-0": 40'-0"
- Beam Spread at 50'-0": 50'-0"
- Beam Spread at 60'-0": 60'-0"
- Beam Spread at 70'-0": 70'-0"
- Beam Spread at 80'-0": 80'-0"
- Beam Spread at 90'-0": 90'-0"
- Beam Spread at 100'-0": 100'-0"

Notes:

- Mounting height is based on a total LFP of 20' at grade.
- Please refer to the "luminaire locations" table for mounting heights.
- Product information can be obtained at www.libraire.com or through your local agent.

DISCLAIMER

This lighting design is not a professional engineering drawing and is provided for informational purposes only, without warranty as to accuracy, completeness, reliability or otherwise. Anybody who uses this lighting design is responsible for verifying the lighting or illumination requirements for any specific project. It is the obligation of the end-user to consult with a professional engineering or lighting consultant to verify the lighting design meets the applicable project requirements for lighting system performance, safety, suitability and effectiveness for use in a particular application. The end-user assumes the responsibility for the lighting design, but not limited to, lighting installation and did not manufacture any control system field components to differ from the calculated performance parameters represented in this lighting design. In no event shall Libraire Lighting be responsible for any loss resulting from any use of this lighting design.

Designer: R.A. BOURBON
Date: June 8, 2014
Drawing No.: 000-000004

Notes:

- Mountings shown are based on a total LFP of 20' at grade.
- Please refer to the "luminaire locations" table for mounting heights.
- Product information can be obtained at www.libraire.com or through your local agent.

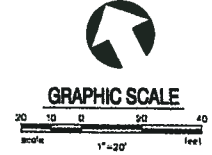

NO.	DATE	DESCRIPTION
1	06-11-14	REVISED FOR PLANNING COMMENTS
2	06-11-14	REVISED FOR PLANNING COMMENTS
3	06-11-14	REVISED FOR PLANNING COMMENTS
4	06-11-14	REVISED FOR PLANNING COMMENTS
5	06-11-14	REVISED FOR PLANNING COMMENTS
6	06-11-14	REVISED FOR PLANNING COMMENTS
7	06-11-14	REVISED FOR PLANNING COMMENTS
8	06-11-14	REVISED FOR PLANNING COMMENTS
9	06-11-14	REVISED FOR PLANNING COMMENTS
10	06-11-14	REVISED FOR PLANNING COMMENTS

535 W. BROAD ST

PRELIMINARY LIGHTING PLAN

PROJECT NO. 000-000004

DATE: 06-11-14

SCALE: 1"=20'

DESIGNER: R.A. BOURBON

DRAWING NO.: 000-000004

PROJECT LOCATION: 535 W. BROAD STREET, RICHMOND, VA

D

CONCEPT PLAN

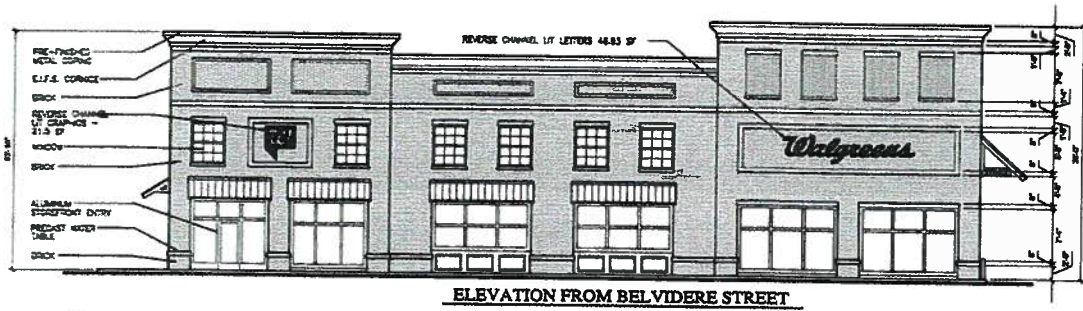

ELEVATION FROM BELVIDERE STREET

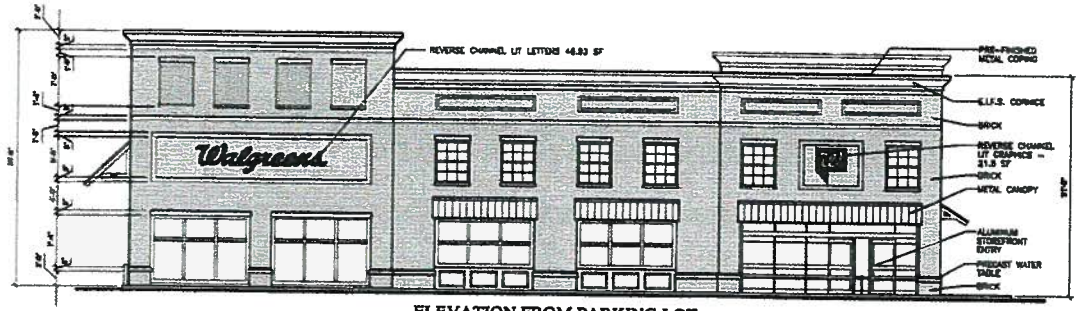

ELEVATION FROM PARKING LOT



ELEVATION FROM BROAD STREET

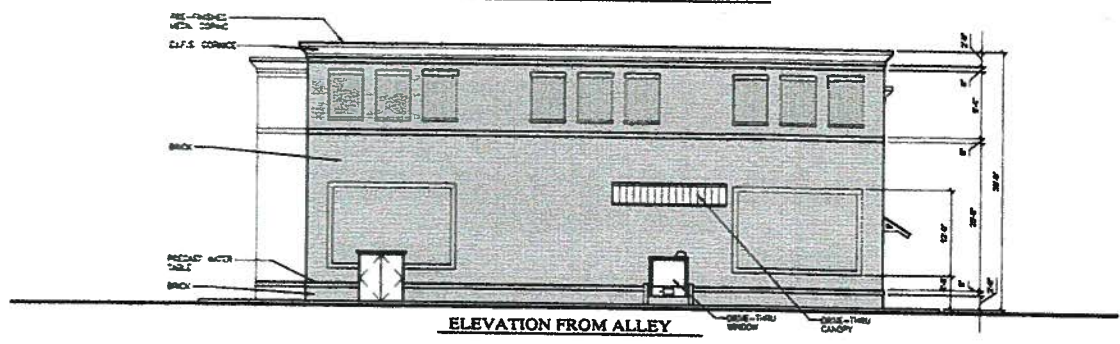

ELEVATION FROM ALLEY

Walgreens

BROAD ST. AND BELVIDERE ST.

RICHMOND

VIRGINIA

PROPOSED EXTERIOR ELEVATIONS
OPTION 4



NOVEMBER 7, 2014



**BARRY BYRD
ARCHITECTURE**

P.O. Box 5482
Knoxville, TN 37928
(865) 687-6500

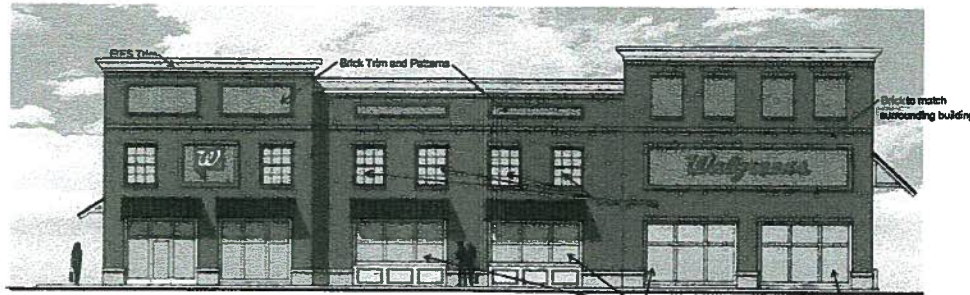

Corner Entry

Elevation from Belvidere Street

Glazing with graphics or display windows as approved by city

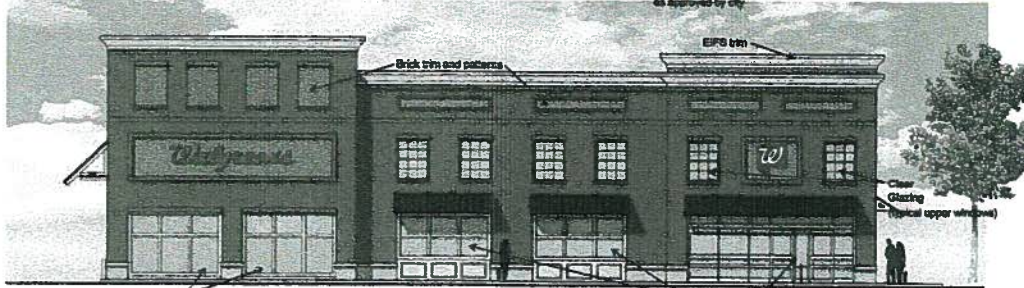

Frosted Glazing

Elevation From Parking Area

Clear glazing



Clear glazing

Elevation From Broad Street

Corner Entrance

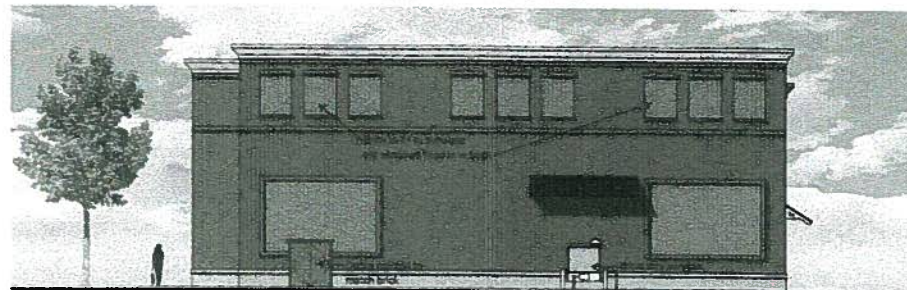

Elevation from Alley

Walgreens

BROAD ST. AND BELVIDERE ST.

RICHMOND

VIRGINIA

Morgan
ARCHITECTS

BARRY BYRD
ARCHITECTURE

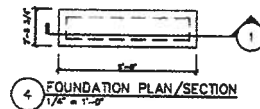
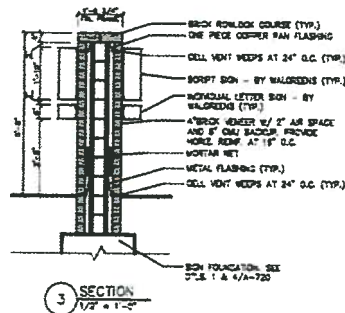
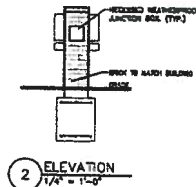
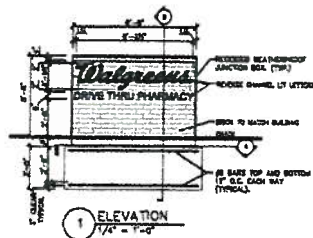

SIGN AREA SUMMARY	
TOTAL SIGN AREA:	48.03 S.F.

GENERAL NOTES

THE MONUMENT SIGN MUST BE INSTALLED AS THE FIRST PRIORITY IN THE CONSTRUCTION SCHEDULE.

THE FOUNDATION WITH STUBBED-IN CONDUITS WILL BE INSTALLED BY THE LANDLORD'S CONTRACTOR AT THE EARLIEST POSSIBLE DATE AFTER THE EXECUTION OF THE LEASE (MINIMUM 60 DAYS PRIOR TO THE STORE FITTING DATE).

THE MONUMENT SIGN WILL BE ELECTRIFIED AS SOON AS POSSIBLE AFTER INSTALLATION.

SHOP DRAWINGS:
SIGN CONTRACTOR SHALL SUBMIT (2) COPIES OF SHOP DRAWINGS TO WALGREENS FOR APPROVAL, PRIOR TO CONSTRUCTION.

ORIENTATION:
SIGN FACE SHALL BE PERPENDICULAR TO THE MAJOR STREET FOR ANY VARIATION TO ACHIEVE, SITE CONDITIONS SHALL GOVERN PROPER ORIENTATION AS APPROVED BY WALGREENS.

WORK RESPONSIBILITY:
THROUGHOUT ALL CONSTRUCTION OF PUBLIC STREETS, WALGREENS SIGN CONTRACTOR WILL PROVIDE SIGN CABINETS, TUBE STEEL SIGN, LEGS, AND BOLT CAGE, ELECTRICAL, POWER, DATA CONDUIT, FOUNDATIONS, AND MONUMENT SIGN BASES ARE BY LANDLORD'S CONTRACTOR.

CONSIDERATIONS:
FOUNDATION CONTRACTOR, PRIOR TO INSTALLING FOUNDATION, SHALL:
1. VERIFY PERMIT REQUIREMENTS WITH WALGREENS SIGN CONTRACTOR.
2. OBTAIN BOLT CAGE FROM WALGREENS SIGN CONTRACTOR.

PERMITS:
ALL REQUIRED PERMITS SHALL BE OBTAINED BY WALGREENS SIGN CONTRACTOR.

STRUCTURAL GENERAL NOTES

- 1) ALL ALUMINUM SURFACES IN CONTACT WITH STEEL SHALL RECEIVE ONE COAT OF EPURMATIC PAINT.
- 2) ALL STRUCTURAL STEEL SHALL BE ASTM A-36.
- 3) ALL STRUCTURAL STEEL SHALL COMPLY WITH THE AISC MANUAL, LATEST EDITION.
- 4) ALL STEEL SHALL RECEIVE ONE SHOP COAT OF RUST INHIBITIVE PAINT.
- 5) DESIGN WIND PRESSURE - 30 LB./SQ. FT.
- 6) MINIMUM CONCRETE STRENGTH TO BE 3000 P.S.I.
- 7) REINFORCEMENT STEEL TO BE ASTM A-618 OR EQ.
- 8) ALLOWABLE SOIL PRESSURE 2500 P.S.F.
- 9) SIGN AND FOUNDATION MUST CONFORM TO LOCAL BUILDING CODES, WIND AND SOIL REQUIREMENTS.



BARRY BYRD ARCHITECTURE

P.O. Box 5482
Knoxville, TN 37928
(865) 687-6500

NOT FOR CONSTRUCTION

THIS DRAWING IS THE PROPERTY OF BARRY BYRD ARCHITECTURE. ANY USE OR REPRODUCTION IN PART OR IN WHOLE IS PROHIBITED WITHOUT THE WRITTEN CONSENT OF BARRY BYRD ARCHITECTURE.

Project Name:
Walgreens

Drawn By:
MMB

Reviewed By:

No.	DATE	DESCRIPTION
1	11-06-14	REVISED L&S
2	11-10-14	REVISED PERMIT

Project Title:
Walgreens



West Broad Street & North Belvidere Street
Store No:

Location:
Richmond, VA

Sheet Contents:
Reader Board Monument Sign Details

Date:
May 20, 2014

Sheet Number:
A-720

