

INTRODUCED: July 26, 2021

AN ORDINANCE No. 2021-204

To amend and reordain Ord. No. 75-309-302, adopted Dec. 15, 1975, as most recently amended by Ord. No. 2018-304, adopted Jan. 14, 2019, pertaining to the “Stony Point Community Unit Plan,” for the purpose of amending the development standards, as they pertain to Map Section A-1 of the Northern Portion of the Plan, to allow for an accessory dwelling unit on the property known as 3417 Stony Point Road.

Patron – Mayor Stoney (By Request)

Approved as to form and legality
by the City Attorney

PUBLIC HEARING: SEP 13 2021 6:00 P.M.

I. That Ordinance No. 75-309-302, adopted December 15, 1975, as most recently amended by Ordinance No. 2018-304, adopted January 14, 2019, be and is hereby amended and reordained as follows:

WHEREAS, by Ordinance No. 75-309-302, adopted December 15, 1975, Council approved a Community Unit Plan for the use and development of 527 acres, more or less, shown on the site plan entitled: “Stony Point” (the “1975 Development Plan”), a copy of which is attached to the draft of Ordinance No. 75-309-302; and

AYES: 8 NOES: 0 AB0STAIN: _____

ADOPTED: SEPT 13 2021 REJECTED: _____ STRICKEN: _____

WHEREAS, by Ordinance No. 80-259-81-2, adopted January 12, 1981, Ordinance No. 82-291-268, adopted December 20, 1982, and Ordinance No. 83-37-38, adopted March 14, 1983, Council amended the 1975 Development Plan; and

WHEREAS, by Ordinance No. 84-11-13, adopted February 13, 1984, Council amended the 1975 Development Plan to approve a revised plan for the southern portion of the tract containing 134 acres, more or less, entitled: "Stony Point", prepared by Clower Associates, Inc., dated October 5, 1983, and revised December 23, 1983, a copy of which is attached to the draft of Ordinance No. 84-11-13 (the "Southern Portion"); and

WHEREAS, by Ordinance No. 85-315-290, adopted December 16, 1985, Council amended the 1975 Development Plan to approve a revised plan for the northern portion of the tract containing 264 acres, more or less, entitled: "General Development Plan: A Community Unit Plan for Stony Point", as revised October 30, 1985, (the "1985 Development Plan"), a copy of which is attached to the draft of Ordinance No. 85-315-290, adopted December 16, 1985; and

WHEREAS, by Ordinance No. 87-198-187, adopted on September 14, 1987, Council amended the 1985 Development Plan to approve a revised plan (the "1987 Development Plan") for the use and development of a 293 acre, more or less, section of the northern portion of the Stony Point Community Unit Plan property (the "Northern Portion") which includes 264 acres already authorized for development pursuant to Ordinance No. 85-315-290, adopted December 16, 1985, together with approximately 30.9 contiguous acres of land added thereto; and

WHEREAS, by Ordinance No. 87-253-228, adopted on November 9, 1987, Council amended the signage requirements for the Southern Portion; and

WHEREAS, by Ordinance No. 88-264-239, adopted on November 14, 1988, Council amended the 1987 Development Plan for the Southern Portion to add "parcel P" to the Southern

Portion, to delete “parcel J” from the Southern Portion, and to change the permitted uses on “parcel F” in the Southern Portion (the “1988 Development Plan”); and

WHEREAS, by Ordinance No. 94-119-122, adopted on June 13, 1994, Council amended the 1987 Development Plan to add hospital, clinical research and accessory uses to the uses permitted on Map Section F within the Northern Portion and to further amend the 1987 Development Plan as necessary to accommodate the additional permitted uses; and

WHEREAS, by Ordinance No. 94-289-95-3, adopted on January 9, 1995, Council amended the 1987 Development Plan to authorize building-mounted signage for buildings within Map Sections C, D, E and F within the Northern Portion; and

WHEREAS, by Ordinance No. 95-241-211, adopted on September 11, 1995, Council amended the 1987 Development Plan to delete existing Map Sections A, B, C and H and an area designated for a public road adjacent thereto as shown on the 1987 Development Plan and substitute a new 1995 Development Plan (the “1995 Development Plan”) showing a new Map Section J and to provide for the uses permitted within new Map Section J; and

WHEREAS, by Ordinance No. 99-213-192 adopted on July 12, 1999, Council amended the 1995 Development Plan to add medical uses and accessory retail/commercial uses to the office use permitted within Map Sections D and E located in the Northern Portion, modify the development summary and map for those sections to adjust the boundary line between those sections, increase the maximum total square foot of floor area permitted in Map Sections D, E, and F of the Northern Portion by 10,000 square feet, and make several ancillary text changes to accommodate the proposed use changes regarding signage and parking requirements; and to further amend the plan as necessary to accommodate the new permitted uses (the “1999 Development Plan”); and

WHEREAS, by Ordinance No. 2001-19-31, adopted on February 12, 2001, Council amended certain requirements regarding traffic conditions within the Northern Portion; and

WHEREAS, by Ordinance No. 2001-273-250, adopted on September 10, 2001, Council deleted Map Section J, as shown on the 1999 Development Plan, substituted a new Development Plan showing Map Sections K and L and provided for the uses and development standards applicable to Map Sections K and L; and

WHEREAS, by Ordinance No. 2001-358-338, adopted on December 10, 2001, City Council substituted a new 2001 Development Plan reflecting modifications to Map Sections K and L of the Northern Portion of the Tract, provided for the uses and development standards applicable to Map Section L and amended the permitted uses and development standards applicable to Map Section K; and

WHEREAS, by Ordinance No. 2002-321-320, adopted on November 25, 2002, City Council added approximately 26.5 acres of land into the Northern Portion of the Tract, removed approximately 2.655 acres of land from Map Section "E", substituted a new 2002 Development Plan reflecting the creation of a new Map Section "M" consisting of such 26.5 and 2.655 acre parcels and authorized development of single family residential uses within Map Section "M"; and

WHEREAS, by Ordinance No. 2004-198-221, adopted on July 26, 2004, City Council authorized extended hours of operation for restaurant tenants in Map Section "K", (ii) set conditions on chain link fencing in Map Section "L" should restaurant uses be developed there, and (iii) required that the owners of Map Section "K" and "L" establish a development review committee and offer area neighborhood associations representations on this committee; and

WHEREAS, by Ordinance No. 2004-326-305, adopted November 22, 2004, City Council (i) added approximately 24.3 acres of land into Southern Map Section "L" by substituting a new

development plan for the Northern Portion of the Tract to reflect the addition of such property to Southern Map Section “L” and (ii) eliminated the office, restaurant and retail uses previously permitted within Southern Map Section “L”; and

WHEREAS, by Ordinance No. 2005-169-149, adopted July 11, 2005 City Council substituted a new development plan which provided for not more than fifteen (15) single-family dwelling units within Map Section M of the Northern Portion of the Tract; and

WHEREAS, by Ordinance No. 2006-232-233, adopted September 11, 2006 City Council authorized a Preliminary Plan Amendment for the Stony Point CUP, Northern Portion, to amend the development standards for Southern Map Section “L” to reduce the swimming pool setback from 350 feet to 315 feet and to create a single-family lot on Cheyenne Road; and

WHEREAS, by Ordinance No. 2010-9-28, adopted February 8, 2010, the City Council authorized a Preliminary Plan Amendment for the Stony Point CUP, Northern Portion, to (i) allow for a specialized movie theater as a permitted retail use within Map Section “K” upon certain terms and conditions; (ii) update the development plan and summary; and (iii) make, at the request of the City, minor corrections to the previous ordinance, including correcting a portion of the community unit plan which referenced a section of the zoning ordinance that had been relocated and re-establishing the maximum height requirement for retail and restaurant development in Northern Map Section “L” that had erroneously been deleted during a previous amendment; and

WHEREAS, by Ordinance No. 2010-200-187, adopted October 25, 2010, the City Council authorized a Preliminary Plan Amendment to authorize an increase in the permitted sign area for the shopping center in Stony Point Southern, Map Section “E”, upon certain terms and conditions, and to reflect the change in the name of the “Department of Community Development” to the “Department of Planning and Development Review”; and

WHEREAS, by Ordinance No. 2013-214-207, adopted November 25, 2013, the City Council authorized a Preliminary Plan Amendment for the purposes of (i) authorizing multi-family residential, office, restaurant, and retail uses in Northern Map Section L, (ii) amending the 2009 Development Plan and the 2009 Development Summary, and (iii) amending the Development Standards and Conditions; and

WHEREAS, by Ordinance No. 2015-23-40, adopted February 23, 2015, the City Council authorized a Preliminary Plan Amendment for the purposes of (i) amending the 2013 Development Plan and the 2013 Development Summary, and (ii) amending the Development Standards and Conditions, as they pertain to Map Section A-1 of the Northern Portion of the Plan to allow for the further subdivision of Lot 3 within Map Section A-1; and

WHEREAS, by Ordinance No. 2017-227, adopted December 11, 2017, the City Council authorized a Preliminary Plan Amendment for the purpose of amending the Development Standards and Conditions, as they pertain to Map Sections A and D of the Southern Portion of the Plan, to allow for additional signage[-]; and

WHEREAS, by Ordinance No. 2018-304, adopted January 14, 2019, the City Council authorized a Preliminary Plan Amendment for the purpose of amending the development standards, as they pertain to Map Section K of the Southern Portion of the Plan, to allow for residential development; and

WHEREAS, the owner of Tax Parcel No. [~~C001-1016/001~~] C001-0757/056 in the Stony Point CUP, [~~Southern~~] Northern Portion, Map Section [~~K~~] A-1 has requested a Preliminary Plan Amendment for the purpose of amending the permitted use [~~and development~~] standards, as they pertain to Map Section [~~K~~] A-1 of the [~~Southern~~] Northern Portion of the Plan, to allow for [~~residential development~~] an accessory dwelling unit at the property known as 3417 Stony Point

Road and identified as Tax Parcel No. C001-0757/056 in the 2021 records of the City Assessor, in accordance with the plans entitled [“Stony Point Landing, Conceptual Layout,” “Stony Point Landing, Landscape Buffer Plan,” and “Stony Point Landing, Common Area Amenities,” all prepared by Youngblood, Tyler & Associates, P.C., dated March 7, 2018, and last revised October 16, 2018] “Saunders Garage-Job 1908,” prepared by Jerome Jackson, and dated February 11, 2021, and “Plot Plan of Lot 1, Block A, Section 2, Chesnut Oaks, a Resubdivision of Lot 3, Block A, Chesnut Oaks and a Portion of Reserved Stony Point Green, Stony Point CUP Map Section A – 1, City of Richmond, Virginia,” prepared by Lewis & Associates, P.C., dated April 16, 2018, and last revised March 4, 2020, copies of which are attached to this amendatory ordinance (the “Requested Amendment”); and

WHEREAS, the Planning Commission (the “Commission”) approved the Requested Amendment based upon findings of fact as set out in a resolution [~~dated and~~] adopted by the Commission [on ~~November 19, 2018~~], a copy of such resolution being attached to this Ordinance; and

WHEREAS, the Council concurs in the findings of fact made by the Commission;

NOW, THEREFORE,

THE CITY OF RICHMOND HEREBY ORDAINS:

That Ordinance No. 75-309-302, adopted December 15, 1975, as most recently amended by Ordinance No. [~~2017-227~~] 2018-304, adopted [~~December 11, 2017~~] January 14, 2019 (the “Ordinance”), be and is hereby amended and reordained as follows:

§ 1. NORTHERN PORTIONS OF THE TRACT

That pursuant to Section 17.10(g) of the Charter of the City of Richmond, and Article V of Chapter 30 of the Code of the City of Richmond [~~(2015)~~] (2020), as amended, the development of

the land shown as Parcel B on the plat of survey dated August 7, 1984, revised October 31, 1984 and inspected February 28, 1986, made by Lewis & Owens, Inc., entitled “Plat Showing Two Parcels North of Huguenot Road Located Within the City of Richmond, Virginia” (“Plat 2”), the land shown on the plat dated July 21, 1987, made by E. D. Lewis & Associates, P.C., entitled “Compiled Plat Showing a Parcel of Land Containing 292.87+ Acres Located North of Evansway Lane in the City of Richmond, Virginia” (“Plat 3”), the land shown on the compiled plat dated July 3, 2001 and revised July 8, 2001, made by Shadrach & Neal, Inc., entitled “Schematic Drawing of Three Parcels of Land Situated on the North and South Lines of Cherokee Road, City of Richmond, Virginia”, and the land shown on the plat dated October 8, 2004, prepared by Balzer and Associates, and entitled “Compiled Plat Showing Two Parcels of Land Lying West of Stony Point Parkway”, all shown as Map Sections A-1, D, E, F, K, L and M on the plan entitled “Stony Point C.U.P. Development Plan,” prepared by E.D. Lewis and Associates, P.C., dated October 22, 2014, and, as to Map Section M, the plan dated February 23, 2005, prepared by Balzer & Associates, entitled “Riverwatch on the James, Stony Point Map Section M, City of Richmond, VA”, which is conceptual in nature, does not show the maximum number of dwelling units authorized for Map Section M, and is not necessarily representative of the subdivision plan under which such map section will be developed (collectively, the “Development Plan” dated October 22, 2014), for the principal uses as set forth on the table attached to this ordinance, entitled “2014 Development Summary (Northern Portions of the Tract)” (the “2014 Development Summary”), and other attendant facilities on the above described property generally in accordance with the Development Plan dated October 22, 2014, and, as to Map Sections D, E, and F, the report entitled “Stony Point Limited Partnership Request for Amendment to Community Unit Plan for Stony Point,” revised October 30, 1985 (the “1985 Report”), as modified by a letter dated May 4, 1987,

to the Commission and the Department of Planning and Community Development, from Hirschler, Fleischer, Weinberg, Cox & Allen, as attorneys for Stony Point Limited Partnership (the “1987 Modification”) (the 1985 Report and the 1987 Modification are hereinafter referred to as the “1985-87 Requests for Amendment”), is hereby approved and permitted upon the following standards, conditions and terms:

A. Definitions and Development Standards:

(1) Definitions: For purposes of this ordinance, the following definitions shall apply:

(a) “Northern Map Section L” shall refer to the portion of the Map Section L located north of Line A as shown on the Development Plan dated October 22, 2014.

(b) “Middle Map Section L” shall refer to the portion of Map Section L located south of Line A and north of Line B, as shown on the Development Plan dated October 22, 2014.

(c) “Southern Map Section L” shall refer to the portion of Map Section L located south of Line B, as shown on the Development Plan dated October 22, 2014.

(d) “Northern Map Section M” shall refer to that portion of Map Section M located north of Cherokee Road as shown on the Development Plan dated October 22, 2014.

(e) “Southern Map Section M” shall refer to that portion of Map Section M located south of Cherokee Road as shown on the Development Plan dated October 22, 2014.

(f) “Perimeter Buffers” shall refer to the buffer areas shown on the Development Plan dated October 22, 2014, along the northern, western and southern outer perimeter boundaries of Map Section L. Except along the western boundary of Southern Map Section L adjoining lots fronting on Lochinvar Road and Cheyenne Road and portions of the northern and western boundaries of Northern Map Section L, if Northern Map Section L is used for multifamily residential use, Perimeter Buffers shall be 100 feet in width as shown on the Development Plan

dated October 22, 2014, with the exception that such buffers may be increased, solely at the option of the developer, by designation on either the final plan or subdivision plat, as applicable, for the affected portion or portions of Map Sections K and L. An increase of the perimeter buffers in any particular area shall not increase the perimeter buffer in any other area. Along the western boundary of Southern Map Section “L” adjoining lots fronting on Lochinvar Road and Cheyenne Road, Perimeter Buffers shall be one hundred fifty (150) feet in width when adjacent to detached residential dwelling units except as provided in Section 1(A)(5)(f)(i) and two hundred fifty (250) feet in width when adjacent to attached residential dwelling units, all as shown on the Development Plan dated October 22, 2014. Along portions of the northern and western boundaries of Northern Map Section L, if Northern Map Section L is used for multifamily residential use, the Perimeter Buffer shall be variable in width and shall be in no case less than one hundred (100) feet in width, all as shown on the Development Plan dated October 22, 2014. The Perimeter Buffers shall be subject to the provisions of Section 1(B)(12) of this ordinance.

(g) “Gross Leasable Area” shall mean the sum of the total horizontal areas of the several floors of all buildings on a lot, measured from the interior faces of exterior walls and from the center line of joint partitions and walls separating two (2) or more buildings. The term “Gross Leasable Area” shall include outdoor dining areas and outdoor display areas that are accessory to enclosed retail stores, but shall exclude areas designed for permanent uses such as public toilets, utility closets, malls (other than any area within malls used for restaurant dining areas), truck tunnels, enclosed parking areas, meters, rooftop mechanical structures, mechanical and equipment rooms, public and fire corridors, stairwells, elevators and escalators.

(h) “In-line restaurant” shall refer to: (1) any restaurant occupying a portion of a building that is occupied by more than one principal use or (2) any restaurant occupying a building

that is attached to one or more other buildings that are, collectively, occupied by more than one principal use. The term “in-line restaurant” shall not be construed to include restaurants that are accessory to an office use as specified in Section 1(A)(6)(e).

(i) “Street” means, when applicable to Southern Map Section M, any privately owned and maintained thoroughfare or portion thereof, which affords the principal means of vehicular access to four (4) or more dwelling units.

(j) “Shared Driveway” means, when applicable to Southern Map Section M, a privately owned and maintained thoroughfare or portion thereof, which affords the principal means of vehicular access from a Street to fewer than four (4) dwelling units, but more than one (1) dwelling unit.

(k) “Driveway” means, when applicable to Southern Map Section M, any privately owned or maintained thoroughfare or portion thereof, which affords the principal means of vehicular access from Street or Shared Driveway to one (1) dwelling unit.

(l) “Fire Apparatus Access Road” means, when applicable to Southern Map Section M, any portion of a Street, Shared Driveway, or Driveway which is required to be designated as a Fire Apparatus Road by the Virginia Statewide Fire Prevention Code (“VSFPC”).

(2) Development Standards for Single-family Detached Housing (Parcel B and the Development Plan dated October 22, 2014- Map Section “A-1”):

(a) Single-family detached dwellings within Parcel B as shown on Plat 2 shall be located on lots of not less than 15,000 square feet in area or less than 90 feet in width. Other requirements applicable to single-family development shall be as set forth in the zoning regulations governing the R-2 zoning district in the Code of the City of Richmond (2004), as amended. The maximum density of such units shall be not more than 1.5 units per acre.

(b) Single-family detached dwellings within Map Section A-1 shall conform to the requirements of the R-1 Single-Family Residential District as set forth in Chapter ~~[114]~~ 30 of the City Code, provided that one accessory building located on the property known as 3417 Stony Point Road and identified as Tax Parcel No. C001-0757/056 in the 2021 records of the City Assessor may be up to 25 feet in height and provided that maximum density, the general configuration of lots, and the 50-foot buffer shall be as shown on the Development Plan dated October 22, 2014, and the plans entitled “A Resubdivision of Lot 3 of Chestnut Oaks, Stony Point CUP Map Section A-1, City of Richmond, Virginia”.

(c) One accessory dwelling unit, accessory to a single-family dwelling, is permitted within Map Section A-1 on the property known as 3417 Stony Point Road and identified as Tax Parcel No. C001-0757/056 in the 2021 records of the City Assessor. The location, size, materials, and height of the accessory dwelling unit must be in substantial compliance with the plans entitled “Saunders Garage-Job 1908,” prepared by Jerome Jackson, and dated February 11, 2021, and “Plot Plan of Lot 1, Block A, Section 2, Chesnut Oaks, a Resubdivision of Lot 3, Block A, Chesnut Oaks and a Portion of Reserved Stony Point Green, Stony Point CUP Map Section A – 1 , City of Richmond, Virginia,” prepared by Lewis & Associates, P.C., dated April 16, 2018, and last revised March 4, 2020, copies of which are attached to and made a part of this amendatory ordinance. The accessory dwelling unit must conform to the yard requirements of the R-1 Single-Family Residential District as set forth in Chapter 30 of the City Code of the City of Richmond (2020), as amended.

(3) Development Standards for Single-family Detached Dwellings within Southern Map Section M:

(a) Permitted Principal and Accessory Uses: The development and use of the dwelling unit lots shall be authorized for and limited to single-family detached dwellings, and those accessory uses and structures which are customarily incidental and clearly subordinate to single-family detached dwelling use.

(b) Minimum Lot Areas: Each lot shall contain no less than 20,000 square feet of land area.

(c) Lot Dimensions; Street Frontage: There shall be no minimum lot dimensions and no Street frontage requirements.

(d) Lawn Landscaping: All lawns shall be sodded and irrigated prior to a final certificate of occupancy for the dwelling unit on the lot.

(e) Building Setbacks; Placement:

(i) All single-family dwellings shall be subject to a minimum building setback of thirty-five (35) feet from the southern line of Cherokee Road, fifty (50) feet from the southern perimeter boundary of Southern Map Section M, and one hundred fifty (150) feet from the eastern perimeter boundary of Southern Map Section M except that where the buffer along the eastern perimeter boundary of Southern Map Section M, as provided for in Section 1(A)(3)(f) of this ordinance, is one hundred (100) feet such setback shall be one hundred (100) feet.

(ii) All single-family dwellings shall be subject to a minimum building setback of thirty-five (35) feet from any Street within Southern Map Section M. No single-family dwelling shall be located closer than ten (10) feet from any property line of the lot on which it is situated, nor closer than twenty (20) feet from the rear property line of the lot on which it is situated. The requirements of this Section 1(A)(3)(e)(ii) may be reduced by up to 10%

in instances where the topography of a particular lot makes it difficult to achieve the stated requirements.

(iii) There shall be no requirement as to the placement of a dwelling unit on any lot relative to the placement of dwelling units situated on any other lots.

(f) Buffers:

(i) A buffer of one hundred fifty (150) feet shall be provided along the eastern perimeter boundary of Southern Map Section M except where such buffer is shown as one hundred (100) feet on the Development Plan dated October 22, 2014.

(ii) Where any building or parking lot within Map Section E is, at the time of approval of the tentative subdivision plat for Map Section M, less than fifty (50) feet from the boundary line between Map Sections E and M, a buffer of twenty (20) feet from the southern perimeter boundary of Map Section M shall be provided. Buffers within Southern Map Section M shall be subject to the provisions of Section 1(B)(12) of this Ordinance.

(g) Dwelling Size: Dwellings shall contain a minimum of 2,400 square feet.

(h) Maximum Height: No dwelling unit shall exceed thirty-five (35) feet in height.

For purposes of this subsection (h), “height” means the vertical distance from the highest finished elevation of the ground adjacent to the exterior walls of a building to the highest point of the coping of a flat roof; to the deck line or highest point of the coping or parapet of a mansard roof; or to the mean height level between the eaves and the ridge of a gable, hip, shed or gambrel roof.

(i) Exterior Materials: Dwellings shall have masonry foundations clad in brick or stone, and any exposed chimney shall be similarly clad. Exterior walls shall be clad in fiber-cement siding, brick, stone, cultured stone, stucco, shingles or a combination thereof. Use of vinyl siding on the exterior walls shall be prohibited.

(j) Driveways/Garages: Each dwelling shall have a garage designed to accommodate the parking of a minimum of one motor vehicle. Driveways and Shared Driveways shall be paved with concrete, cast concrete, cobblestones, brick pavers, asphalt and/or similar material.

(k) Restrictive Covenants/Homeowners' Association: The owner of Map Section M shall prepare and cause to be recorded among the land records of the City of Richmond all necessary documentation, consisting of agreements, covenants, and/or restrictions, to regulate the development and use of Map Section M so as to be in accordance with the terms and conditions of this Ordinance, as well as provide for promulgation of standards for the construction, architecture, and use of all land within Map Section M. Such documentation shall establish a homeowners' association and shall set forth responsibility of the homeowners' association for the operation, maintenance, and funding for all privately owned common areas, including but not limited to buffers, pedestrian areas, storm drainage facilities, Streets, parking areas, and recreation areas (the "Common Areas").

(4) Use and Restrictions of Northern Map Section M:

(a) Use: Lots in Northern Map Section M shall be used only for recreation by the owners of Northern Map Section M, the residents of dwellings and owners of lots within Southern Map Section M and their guests and invitees, and for storm drainage. Access to Northern Map Section M by the general public shall be prohibited. No permanent structure other than fencing, a driveway with a parking area (as restricted in Section 1(B)(11) of this Ordinance), gazebos or similar such structure, facilities or racks to house canoes, kayaks or other such small boats, docks and similar structures, and those associated with any storm drainage structures may be constructed in Northern Map Section M. At no time shall Northern Map Section M be utilized for the storage of any trailers or motor vehicles. Removal and thinning of underbrush and trees, and mowing or

bush hogging of fields and open areas shall be permitted to allow for recreational uses, storm drainage facilities, and to provide and maintain view corridors and access to the James River from Southern Map Section M, subject to the applicable provisions of the Chesapeake Bay Preservation Act. Fencing shall be installed and maintained by the owners of each of the Northern Lots (as hereinafter defined) at all points where such lots are adjacent to Cherokee Road, with a gate at the permitted driveway.

(b) Subdivision: Northern Map Section M, as shown on the Development Plan dated October 22, 2014, may be subdivided into not more than three (3) lots (the “Northern Lots”). At the option of the developer of Map Section M, Lot M-1 may be conveyed to the owner of that property known as 9319 Cherokee Road and identified as tax parcel C001/0374-022, and Lot M-2 may be conveyed to the owner of that property known as 9307 Cherokee Road and identified as tax parcel C001/0374-024 (each a “Primary Property”). Lot M-3 and any portion of Lots M-1 and M-2, which are not conveyed to the owner of the Primary Property, shall be a part of the Common Areas. In the event of either of Lots M-1 or M-2 is conveyed to the owner of a Primary Property, the conveyed lot shall become a part of the respective Primary Property and may not be further conveyed except as a part of the respective Primary Property. This requirement shall be placed on each Northern Lot as a restrictive covenant at the time of the sale of such Northern Lot to the owner of a Primary Property.

(5) Development Standards for General Residential Housing (the Development Plan dated October 22, 2014 - Southern Map Section L)

(a) Maximum development and maximum density shall be as set forth on the 2014 Development Summary.

(b) Permitted Uses: Single-family detached dwellings, single-family attached dwellings, multi-family dwellings; swimming pools, garages, car wash facility, clubhouses and community centers for use by owners, residents and their guests; maintenance facilities; trash compactors; mailboxes; and other accessory uses and structures which are customarily incidental and clearly subordinate to such uses; and, in connection with the development of any project within Southern Map Section L, dwelling units within any such project may be used as model homes and one dwelling unit within any such project may be used as a sales center. All such uses may be developed under a condominium form of ownership or on individual lots and, for purposes of this Ordinance, dwellings which are configured as single-family detached dwellings or single-family attached dwellings (such as townhouses, row houses or cluster houses) whether constructed under a condominium form of ownership or on individual lots shall be deemed to be single-family detached dwellings or single-family attached dwellings and shall not be classified as multi-family dwellings.

(c) Lot and Dwelling Sizes and Road Requirements: There shall be no lot size requirements, no lot dimension requirements, no front, side or rear yard requirements, no setback requirements between buildings, no dwelling size requirements and no public street frontage requirements and all access may be provided by private roads or streets.

(d) Minimum off-street parking requirements shall be as set forth in Chapter 30 of the Code of the City of Richmond [~~(2015)~~] (2020), as amended.

(e) Maximum height shall be three (3) stories, with the exception of four (4) stories for multi-family buildings.

(f) Building and Structure Setbacks:

(i) All single-family detached dwellings and structures accessory to such dwellings shall be subject to a minimum setback from the western and southern outer perimeter boundaries of Southern Map Section L equal to the width of the applicable Perimeter Buffer. One (1) lot for the construction of a single-family detached dwelling shall be permitted within said setback and buffer area, fronting on Cheyenne Road, substantially as shown on the Development Plan dated October 22, 2014. Said lot shall be subject to the minimum yard requirements specified by the R-2 Single-Family Residential district, as set forth in Chapter 30 of the Code of the City of Richmond [~~(2015)~~ (2020)], as amended.

(ii) All single-family attached dwellings and all multi-family dwellings and structures accessory to such dwellings shall be subject to a minimum setback from the western and southern outer perimeter boundaries of Southern Map Section L equal to the greater of (i) 100 feet or (ii) the width of the applicable Perimeter Buffer; provided, however, no single-family attached dwellings or multi-family buildings shall be located south of Line C, as shown on the Development Plan dated October 22, 2014. Garages, maintenance and car washing facilities, and other accessory uses and structures which are customarily incidental and clearly subordinate to such dwelling uses may be located south of Line C. All dwellings located west of Line D, as shown on the Development Plan dated October 22, 2014, shall be single-family attached or single-family detached dwellings or condominiums configured as single-family attached or single-family detached dwellings, whether located on individual lots or one or more lots.

(iii) No buildings which serve as community clubhouses or indoor community swimming pools shall be located south of Line C, as shown on the Development Plan dated

October 22, 2014, and no outdoor community swimming pools shall be located within 315 feet of the western and southern outer perimeter boundaries of Southern Map Sect. L.

(g) Additional Standards Applicable West of Line D:

(i) Building Materials: Exterior building siding materials for dwellings shall be brick, stone, cast stone or cement board siding and roofing materials shall be architectural dimensional shingles or of such other materials approved by the Commission in connection with final plan review. The lot for the conversion of a single-family detached dwelling fronting on Cheyenne Road shall not be subject to the forgoing building material requirements.

(ii) Common Areas: Community facilities, such as a clubhouse, swimming pool or outdoor gathering area, may be provided for use by owners, residents and their guests.

(iii) Size and Design: All dwellings shall have a minimum of two (2) bedrooms and two (2) bathrooms and more than fifty percent (50%) of the dwellings will have three (3) bedrooms and two and one half (2.5) bathrooms.

(6) Development Standards for Office – (the Development Plan dated October 22, 2014, Map Sections D, E, F and Middle Map Section L and Northern Map Section L): On Map Sections D, E and F, in addition to office use, clinical research and health care facilities, both inpatient and outpatient (“Medical Uses”) containing a maximum of forty-two (42) inpatient beds shall be permitted as principal uses. If Northern Map Section L is used for multi-family residential use, then office use, with the exception of office use incidental and subordinate to the multi-family residential use, retail and restaurant uses shall not be permitted in Northern Map Section L:

(a) Maximum development, maximum density, minimum gross open space, and minimum livability space shall be as set forth on the 2014 Development Summary. Maximum development for Map Section L shall be subject to the following additional restrictions:

(i) Within Northern Map Section L, office development shall not exceed 200,000 square feet.

(ii) Within Middle Map Section L, office development shall not exceed 60,000 square feet.

(b) The maximum height of buildings within the particular Map Sections shall be as follows:

Map Section D - six (6) stories.

Map Section E - eight (8) stories.

Map Section F - ten (10) stories.

Northern Map Section L – four (4) stories.

Middle Map Section L – two (2) stories.

If, in conjunction with submission for final plan approval, any building to be constructed on Map Sections D, E or F is proposed to be of greater height than stated above and described in the 1985-1987 Requests for Amendment or is proposed to be located closer to the perimeter of the property than is shown on the Development Plan dated October 22, 2014, then its location shall be subject to specific review and approval by the Commission, with particular consideration for the potential impact of such building on existing or potential development on adjacent properties, and the topography and physical constraints of the subject site.

(c) Minimum off-street parking requirements: for office use, four (4) parking spaces per 1,000 square feet of gross office and/or medical use floor area. Parking space dimensions,

access aisles and maneuvering areas shall be in accordance with normal city standards, provided that up to twenty-five percent (25%) of the spaces serving a tenant or owner having an assigned parking program for employees may be of compact car dimensions, subject to final plan approval by the Commission.

(d) Accessory uses on Map Sections D, E and F: Restaurant and cafeteria facilities and shops for the sale of gifts, flowers, drugs, optical products, hearing aids and similar items primarily for the convenience of employees, patients and visitors may be located within office, and medical use buildings, provided that there shall be no signs, displays or show windows visible from the exterior of the buildings, and there shall be no direct public entrance to such uses from the exterior of the buildings. Such accessory uses shall not occupy in the aggregate more than ten percent (10%) of the floor area of buildings where fifty percent (50%) or more of the floor area is devoted to medical uses and shall not occupy in the aggregate more than five percent (5%) of the floor area of buildings where less than fifty percent (50%) of the floor area is devoted to medical uses.

(e) Accessory Uses on Map Section L: Coffee shops, bakeries, delis, take-out food facilities, day care facilities, health clubs and fitness centers may be located within office and medical use buildings located within Map Section L, provided that (i) there shall be no signs, displays or show windows visible from the exterior of the buildings, and there shall be no direct public entrance to such uses from the exterior of the buildings and (ii) in Middle Map Section L, such uses shall be limited to coffee shops, delis and fitness centers which occupy in the aggregate not more than five percent (5%) of the floor area of the building in which such uses are located.

(f) Building Setbacks:

(i) Northern Map Section L: All office buildings constructed within Northern Map Section L shall be subject to minimum building setbacks of 250 feet for one (1) to

three (3) story buildings and 300 feet for four (4) story buildings, all measured from the northern and western outer perimeter boundaries of Northern Map Section L.

(ii) Middle Map Section L: All office buildings constructed within Middle Map Section L shall be subject to a minimum building setback of 135 feet from the western outer perimeter boundary of Middle Map Section L.

(7) Development Standards for Retail, Restaurants and Hotels - (the Development Plan dated October 22, 2014 Map Section K)

(a) Maximum development, maximum density, minimum gross open space, and minimum livability space shall be as set forth on the 2014 Development Summary.

(b) Off-street parking requirements:

(i) Retail and restaurants: a minimum of four (4.0) spaces and a maximum of five (5.0) spaces per 1,000 square feet of gross leasable area.

(ii) Hotel: minimum parking requirements for the hotel use shall be as set forth in Chapter 30 of the Code of the City of Richmond [~~(2015)~~] (2020), as amended.

(iii) All required off-street parking for uses within Map Section K shall be located on Map Section K. Parking areas may be located on one or more separate subdivided parcels and buildings and the parking areas for such buildings need not be located on the same subdivided parcel provided appropriate cross-easement arrangements are established.

(c) Maximum height:

(i) Retail and restaurants: sixty (60) feet above grade excluding screening parapets, skylight monitors, elevator towers, mechanical equipment, antennae (subject to

the height limitations set forth in section 30-692.4 of the Code of the City of Richmond [~~(2015)~~] (2020), as amended) and chimneys which may extend above such limit.

(ii) Hotel: 6 stories

(d) The retail shopping center to be constructed on Map Section K shall be designed as an open-air pedestrian mall and no motor vehicle driveways will be located within the pedestrian mall. Pedestrian areas of such shopping center shall include decorative lighting, landscaping and hardscaping and may also include water features, seating areas, sculptures and other decorative items, all to be approved conceptually by the Commission as a part of final plan review with the actual details relative to such items to be reviewed and approved by the Director of Planning and Development Review who shall be authorized to review and approve or disapprove such details in lieu of Commission review and action. Any plans submitted under this section that are disapproved by the Director shall, at the request of the applicant, be submitted to the Commission for its review. Request for such review shall be made in writing to the Secretary of the Commission within thirty (30) days of the disapproval of a plan by the Director. After reviewing the plan, the Commission may affirm the decision of the Director of Planning and Development Review or instruct the Director to approve the plan. The action by the Commission shall be by formal resolution approved by a majority of the members.

(e) No free-standing fast-food restaurants, convenience stores, food courts (food service areas where multiple vendors share a common seating area), movie theaters (except as provided for herein) or auto service facilities shall be permitted within Map Section K. One combination restaurant and multi-screen movie theater shall be permitted within Map Section K subject to the following conditions:

(i) Such facility shall not be a freestanding building but shall be located within the shopping center as shown on the Development Plan dated October 22, 2014.

(ii) No such facility shall be located west of Line F as shown on the Development Plan dated October 22, 2014.

(iii) Such facility shall be no larger than 40,000 square feet of Gross Leasable Area and shall contain no more than seven (7) screens.

(iv) Except when utilized for a private function, the theater portions of such facility shall be restricted to persons aged 21 and older. Private functions may include, but are not limited to, closed circuit television and presentations, occasional exhibits, educational classes, community meetings; and the conduct of such other activities that can make use of the projection, food service and gathering facilities as are usual and customary from time to time for movie theaters.

(v) Such facility shall not be an Adult Entertainment Establishment nor an Adult Motion Picture Theater as defined by the Code of the City of Richmond [~~(2015)~~ (2020)], as amended.

(f) All roof-mounted mechanical equipment and dish antennae must be screened from ground level view from (i) adjacent public streets, (ii) all residentially zoned properties adjacent to perimeter buffers of 100 feet or greater in width and (iii) single-family development within Map Section A-1 by parapet walls or other means which may be approved by the Commission.

(g) All ground-mounted mechanical/electrical equipment and loading docks must be screened from ground level view from (i) adjacent public streets, (ii) all residentially zoned properties adjacent to perimeter buffers of 100 feet or greater in width and (iii) single-family

development within Map Section A-1 by fences, walls, vegetation or other means which may be approved by the Commission.

(h) All parking lot lighting shall utilize sharp cut-off metal halide luminaries and shall be designed and operated so that the lighting levels from the parking lots, measured at the northern, western and southern outer perimeter boundaries of Map Section L where adjacent to perimeter buffers of 100 feet or greater in width will be not more than one quarter (0.25) foot candle. All business parking lot lighting shall be reduced to security levels (which uses approximately 25% of the total lighting fixtures used for normal operating levels) within one (1) hour after closing of all businesses. Light poles located on Map Section K within 200 feet of the northern, western and southern outer perimeter boundaries of Map Section L shall not be more than 30 feet high and all other light poles located on Map Section K shall not be more than 50 feet high.

(i) Lighted signs facing the residential properties located adjacent to the northern, western and southern perimeter boundaries of Map Section L, where adjacent to perimeter buffers of 100 feet or greater in width, shall be turned off within one (1) hour after closing of the business or businesses identified by such signs.

(j) The number of loading areas designed for pickup or delivery of inventory, supplies and equipment shall be limited to a maximum of seven (7) for the mall building, plus one (1) for each anchor store.

(k) No less than ten percent (10%) of the total area within Map Section K to be disturbed for development shall be landscaped with grass, shrubs (including mulched beds), trees or other natural plant materials. Ponds, lakes or other water features may not be used to satisfy this requirement.

(l) Routine parking lot cleaning activities shall be limited to the hours between 7:00 a.m. and 5:00 p.m., Monday through Saturday. The daily phasing of such activities on Map Section K shall begin on the eastern side of Map Section K.

(m) Refuse collection shall be limited to the hours between 7:00 a.m. and 5:00 p.m., Monday through Saturday. The daily phasing of such activities on Map Section K shall begin on the eastern side of Map Section K.

(n) Hours of Operation:

(i) Retail: Retail uses within Map Section K shall not be opened to the public before 10:00 a.m. or after 9:00 p.m. Monday through Saturday, and shall not be opened to the public before 10:00 a.m. or after 6:00 p.m. on Sunday. However, such hours may be extended during the major holiday season.

(ii) Restaurants within Map Section K shall not be opened to the public before 10:00 a.m.; however, restaurants may open to the public beginning at 6:30 a.m. provided that the total area of such restaurant uses opened before 10:00 a.m. shall not exceed an aggregate area of 15,000 square feet of gross leasable area.

(iii) Restaurants and movie theaters within Map Section K shall not be opened to the public after 1:00 a.m. Sunday through Wednesday or 2:00 a.m. Thursday through Saturday provided that (a) no outdoor dining areas of any restaurant and (b) no restaurant located west of Line F as shown on the Development Plan dated October 22, 2014, shall be opened to the public after 12:00 a.m. daily.

(o) Final detailed drainage plans which are required to be submitted as part of the submission for final plan approval for the shopping center to be constructed on Map Section K shall be consistent with the following drainage concept: Stormwater runoff from the parking areas

and roof of the shopping center shall generally be directed to detention/retention facilities. Such final detailed drainage plans shall comply with all applicable laws and regulations, including the provisions of the City of Richmond Zoning Ordinance implementing the Chesapeake Bay Preservation Act, and in accordance with such laws and regulations shall provide for the release of storm water runoff at a rate and quality level similar to the rate and quality prior to development. Trash guards shall be placed on the detention pond outflow riser structures.

(p) Any hotel constructed within Map Section K shall be located east of the “Hotel Setback Line”, as shown on the Development Plan dated October 22, 2014.

(q) Any free-standing restaurant within Map Section K shall be subject to a minimum building setback of 450 feet from the western outer perimeter boundary of Map Section L.

(r) All retail buildings (other than free-standing restaurants) constructed within Map Section K shall be subject to a minimum building setback of 250 feet from the northern, western and southern outer perimeter boundaries of Map Section L.

(s) Construction activities on Map Section K shall be conducted within fencing which shall be installed in connection with site preparation.

(8) Development Standards for Retail and Restaurants (the Development Plan dated October 22, 2014 Northern Map Section L; Retail and restaurant uses shall not be permitted within Middle Map Section L or within Southern Map Section L):

(a) Maximum development and maximum density shall be as set forth on the 2014 Development Summary.

(b) Minimum parking requirements shall be as set forth in Chapter 30 of the Code of the City of Richmond [~~(2015)~~] (2020), as amended, unless the Commission approves a reduction in connection with final plan approval.

(c) Maximum height: one (1) story

(d) Retail and restaurant uses within Map Section L shall be restricted to the following:

Restaurants (except that no outdoor entertainment, free-standing fast-food restaurants or restaurants with drive-thru facilities shall be permitted); banks and similar financial institutions; financial services; and real estate and insurance offices. No more than two (2) restaurants shall be permitted and the gross leasable area of the restaurants shall not exceed a total of 15,000 square feet.

(e) Building Setbacks:

All retail and restaurant buildings constructed within Northern Map Section L shall be subject to minimum building setbacks of 450 feet from the northern and western outer perimeter boundaries of Northern Map Section L.

(f) Hours of Operation:

(i) Retail: Retail uses within Northern Map Section L shall not be opened to the public before 10:00 a.m. or after 9:00 p.m. Monday through Saturday, and before 10:00 a.m. or after 6:00 p.m. on Sunday. However, such hours may be extended during the major holiday season.

(ii) Restaurants within Map Section L shall not be opened to the public before 10:00 a.m. or after 12:00 midnight.

(g) The provisions of Section 1(A)(8) shall not be deemed to apply to uses accessory to office uses permitted pursuant to Section 1(A)(6)(e).

(9) Additional Development Standards applicable to all uses within the Development Plan dated October 22, 2014, Map Section L, other than single-family detached dwellings and,

except as provided in Section 1(A)(9)(f), other residential and accessory uses located west of Line D, shall be as follows:

(a) All roof-mounted mechanical equipment and dish antennae must be screened from ground level view from (i) adjacent public streets, (ii) all residentially zoned properties adjacent to perimeter buffers of 100 feet or greater in width and (iii) single-family development within Map Section A-1 by parapet walls or other means which may be approved by the Commission.

(b) All ground-mounted mechanical and electrical equipment and loading docks must be reasonably screened from ground level view from (i) adjacent public streets, (ii) all residentially zoned properties adjacent to perimeter buffers of 100 feet or greater in width and (iii) single-family development within Map Section A-1 by fences, walls, vegetation or other means which may be approved by the Commission.

(c) All parking lot lighting shall utilize sharp cut-off luminaires and shall be designed and operated so that the lighting levels from the parking lots serving permitted uses in Northern Map Section L and Middle Map Section L, measured at the northern, western and southern outer perimeter boundaries of Northern Map Section L and Middle Map Section L, where adjacent to perimeter buffers of 100 feet or greater in width, shall be not more than one quarter (0.25) foot candle. All parking lot lighting for office, retail and restaurant uses shall utilize metal halide luminaires and shall be reduced to security levels (which uses approximately 25% of the total lighting fixtures used for normal operating levels) within one (1) hour after closing of the business or businesses served by such parking areas. Light poles located in Map Section L shall not be more than thirty (30) feet high.

If Northern Map Section L is used for multi-family residential use, all parking lot lighting within Northern Map Section L shall be of residential scale and decorative style, may utilize metal

halide or high pressure sodium luminaries, and the height of private lighting within Northern Map Section L shall be limited to twelve (12) feet in height, and where adjacent to the Perimeter Buffer along the property line of Northern Map Section L, the private lighting shall be limited to eight (8) feet in height and have directional shields. The lighting for multi-family residential uses within Northern Map Section L shall be generally in conformance with the lighting plan details contained in the Sheet C1.2 of the plans entitled "Stony Point, Richmond, Virginia" prepared by Design Resource Group, dated January 14, 2013, and last revised September 25, 2013. No up lighting shall be permitted on any of the buildings on Northern Map Section L, if used for multi-family residential use.

(d) Routine parking lot cleaning activities, refuse collection and deliveries by vehicles with more than two axles or six total wheels shall be limited to the hours between 7:00 a.m. and 5:00 p.m., Monday through Friday and between 9:00 a.m. and 1:00 p.m. on Saturday.

(e) No signs facing the residential properties located adjacent to the northern, western and southern perimeter boundaries of Map Section L, where adjacent to perimeter buffers of one hundred (100) feet or greater in width, shall be lighted. If Northern Map Section L is used for multi-family residential use, no signs located in Northern Map Section L, within 250 feet of the western or northern perimeter boundaries of the property, shall be lighted.

(f) The owner of each parcel within Map Section L shall (i) cause all erosion and sediment control facilities installed during construction to be inspected not less than three (3) times each week when construction activities are ongoing and after every significant rainfall, (ii) cause the correction of any damage to or deficiency in the installation or operation of the erosion and sediment control devices and (iii) maintain records of such inspections and corrections. If any inspection discloses any damage or deficiency, any construction activities which shall result in

additional erosion or sediment which the correction of the damage or deficiency would prevent, shall be halted pending correction of the damage or deficiency. Notwithstanding any provision of this Ordinance to the contrary, this Section 1(A)(9)(f) shall apply to single-family attached development west of Line D.

(g) The quantity (proportionate to size of areas) and quality of landscaping materials within parking areas and green spaces for office and retail uses within Map Section L shall be not less than the quantity and quality of materials as required by the Commission for the initial development of the office buildings within Map Sections D and E located at 8730, 9020 and 9030 Stony Point Parkway as shown on the approved landscaping plans for those buildings.

(h) No less than ten percent (10%) of the total area within Map Section L to be disturbed for development for uses other than single-family detached dwellings shall be landscaped with grass, shrubs (including mulched beds), trees or other natural plant materials. Ponds, lakes or other water features may not be used to satisfy this requirement.

(10) Development Standards for Multi-Family Housing Development Plan dated October 22, 2014 – Northern Map Section L):

(a) Maximum development and maximum density shall be as set forth on the 2014 Development Summary, provided, however, if Northern Map Section L is used for multi-family residential use as provided herein, then office use, with the exception of office use incidental and subordinate to the multi-family residential use, retail and restaurant uses shall not be permitted in Northern Map Section L.

(b) Permitted Uses: Multi-family dwellings; leasing office space, swimming pools, garages, car wash facility, clubhouses and community centers for use by owners, residents and

their guests; maintenance facilities; trash compactors; mailboxes; and other accessory uses and structures which are customarily incidental and clearly subordinate to such use.

(c) Lot and Dwelling Sizes and Road Requirements: There shall be no lot size requirements, no lot dimension requirements, no front, side or rear yard requirements, no setback requirements between buildings, no dwelling size requirements and no public street frontage requirements and all access may be provided by private roads or streets.

(d) Minimum off-street parking requirements shall be as set forth in Chapter 30 of the Code of the City of Richmond (2015), as amended.

(e) Maximum height shall be four (4) stories.

(f) Building and Structure Setbacks: All structures constructed within Northern Map Section L shall be subject to minimum building setbacks measured from the northern outer perimeter boundary of Northern Map Section L of 200 feet for one (1) to two (2) story structures and 300 feet for three (3) to four (4) story structures; and minimum building setbacks measured from the western outer perimeter boundary of Northern Map Section L of 250 feet for one (1) to three (3) story structures and 300 feet for four (4) story structures. Any outdoor swimming pool shall be set back at least 350 feet from the northern and western outer perimeter boundaries of Northern Map Section L.

(g) Exterior building siding materials for residential structures and community facilities shall be brick, stone, cast stone or cement board siding, and roofing materials shall be architectural dimensional shingles or of such other materials approved by the Commission in connection with final plan review.

(h) Common Areas: Community facilities, such as a clubhouse, swimming pool or outdoor gathering area, shall be provided for use by owners, residents and their guests.

(i) No gardens, patios or other areas open to owners, residents or guests shall be permitted on the roof of any building.

(j) The building elevations facing the northern or western perimeter boundaries of the Northern Map Section L property shall not contain balconies.

(k) Landscaped screening shall be provided generally along the six (6) foot high metal fence and parking areas, generally in conformance with the details contained in the Planting/Screening Exhibit (Exhibit 2.0) prepared by Design Resource Group, dated July 31, 2013, last revised September 25, 2013, and attached to this Ordinance. Landscaping of Northern Map Section L shall not be limited to the landscaped screening shown on Exhibit 2.0.

B. Conditions Applicable to the Development Plan dated October 22, 2014:

(1) Development standards for individual sections of the Plan shall be as set forth in “Development Standards” (A, Supra).

(2) Within the area adjacent to the dwellings located on Saratoga Road south of Yuma Road, Stony Point Parkway shall not be moved closer to the dwellings than as shown on the Development Plan dated October 22, 2014. Subject to receipt of any approval required from Dominion Virginia Power, or its successor, an eight (8) foot high vinyl coated chain link fence shall be constructed along the inside boundaries of the Perimeter Buffers of 100 feet or greater in width; provided, however no fence shall be required along the western boundary of Southern Map Section L adjoining lots fronting on Lochinvar Road or Cheyenne Road where the width of the Perimeter Buffer is one hundred fifty (150) feet or greater. The vinyl coating on the chain link fence shall be black in color, and all hardware and poles used in connection with the fence shall be either vinyl coated or painted and be black in color. At the request of any adjacent property owner made prior to final plan approval for the phase of development located adjacent to such

owner's property, the developer shall install a gate in the chain link fence, subject to (i) the approval of the Commission, (ii) the written agreement of such homeowners to maintain the gates and keep them locked and (iii) the written acknowledgement of such homeowners that the developer and its successors assume no obligation to maintain the gates, nor any liability due to the failure of such homeowner to provide locks for the gates or to keep the gates locked, such written agreement and acknowledgment to be recorded among the land records of the City of Richmond as covenants running with the land. The chain link fencing described above shall be modified subject to the following conditions:

a. Where Stony Point Parkway is located within 200 feet of the western boundary of Map Section L, the chain link fence in such area shall be replaced with a ten (10) foot high opaque, non-scalable fence with acoustical design. If Northern Map Section L is used for multi-family residential use, the chain link fence shall be replaced with a six (6) foot high metal fence generally along the inside boundary of the Perimeter Buffer within Northern Map Section L, generally in conformance with the details contained in Sheet C1.1, entitled "Site Plan Rendering," dated January 14, 2013, and last revised September 25, 2013, and Exhibit 2.0, entitled "Planting / Screening Exhibit," dated July 31, 2013, and last revised September 25, 2013, of the plans entitled "Stony Point, Richmond, Virginia" and prepared by Design Resource Group, subject to receipt of any approval required from Virginia Electric and Power Company, a Virginia corporation ("VEPCO"), its successors and assigns, and except as provided in Section 1(B)(2)(b). Such fence located in Northern Map Section L may:

(i) contain gates, or be constructed with such other materials and design features necessary to span any stream banks located on Northern Map Section L

such that stormwater may flow freely, as required by and subject to the approval of the Virginia Department of Environmental Quality and the Water Resources Division of the Department of Public Utilities of the City; and

(ii) contain a gate necessary for pedestrian and vehicular access to the utility easement area within Northern Map Section L. The fence and gate across the portion of the utility easement located on Northern Map Section L shall be subject to approval by VEPCO, its successors and assigns. Any gate necessary for pedestrian and vehicular access to the utility easement on Northern Map Section L shall be accessible by VEPCO, its successors and assigns, contractors and agents for the purposes of accessing the easement area in accordance with the terms of the easement agreement and shall not be open to the public.

The owner of the Northern Map Section L property shall monitor and take reasonable actions to ensure compliance with the requirement of non-public access through such gate provided for access to the utility easement area, subject to the approval of VEPCO, its successors and assigns.

b. Where any access road is located between Stony Point Parkway and the parking areas for office, retail or restaurant uses within Northern Map Section L within 200 feet of the western boundary of Map Section L, the chain link fence in such area and, subject to any approval required from VEPCO, or its successor, extending to the northern end of the VEPCO easement crossing the western line of Map Section L, shall be replaced with a ten (10) foot high opaque, non-scalable fence (acoustical design not required).

c. Where any access road is located between Stony Point Parkway and the parking areas within Middle Map Section L within 200 feet of the western boundary of

Map Section L, the chain link fence in such area and extending south to the northern corner of the northernmost building located on Middle Map Section L shall be replaced with a ten (10) foot high opaque, non-scalable fence (acoustical design not required).

d. Where (i) any parking areas within Middle Map Section L extend west of the eastern one half (1/2) of the westernmost office building located on Middle Map Section L or (ii) any parking areas within Northern Map Section L or Middle Map Section L located west of the eastern face of the westernmost office building located on Middle Map Section L have more than one (1) drive aisle, the chain link fence in such area extending south to the southern edge of the parking area shall be replaced with a ten (10) foot high opaque, non-scalable fence (acoustical design not required).

e. In the case that a freestanding restaurant or any in-line restaurant containing more than four thousand (4,000) square feet of gross leasable area is developed in Northern Map Section L, the chain link fence in Northern Map Section L shall be replaced with a ten (10) foot high opaque, non-scalable fence (acoustical design not required), subject to any approval required from Dominion Virginia Power, or its successor for fencing within the Dominion Virginia Power easement crossing the western line of Map Section L. Restaurants that are accessory to an office use as specified in Section 1(A)(6)(e) shall not be subject to this provision.

Other than within areas located west of Line D within Southern Map Section L, the perimeter buffers shall be supplemented in those areas within Map Section L adjacent to residential properties on which a dwelling exists at the time of final plan approvals for such areas with one (1) evergreen tree (e.g. Leyland Cypress 8 feet high) for every ten (10) linear feet of such boundaries, to be planted on either side of the perimeter fencing in locations specified by the

adjacent property owner and as approved by the Commission. Notwithstanding any provision of the preceding sentence to the contrary, perimeter buffer supplementation in the form of landscaped screening shall also be provided in Northern Map Section L if Northern Map Section L is used for multi-family residential use, subject to the provisions of Section 1(A)(10)(k) of this Ordinance.

Subject to approval by the Commission, the developer of any parcel within Map Sections K and L may propose alternatives to the fencing and screening described in this section, including the substitution of vegetative screening for any required opaque fencing provided, (i) vegetative screening shall not be substituted for any required chain link fencing, (ii) in any area where vegetative screening is substituted for opaque fencing, chain link fencing shall be installed along with the vegetative screening, (iii) with respect to any development within Map Section L, the proposed alternatives have been presented to the architectural review committee to be established pursuant to Section 1B(22) of this Ordinance and (iv) the Commission concludes that such vegetative screening shall provide an equally effective visual barrier.

Installation of all fencing and screening, including planting of trees, to be provided pursuant to this section, shall be phased to avoid pre-mature clearing and disturbance of areas adjacent to the perimeter buffers. Such fencing and screening shall be installed adjacent to each portion of the perimeter buffers in those areas of Map Sections K or L which have received subdivision and final plan approval and on which clearing, grading or other construction activities are commenced pursuant to such final plan approval, with installation of the fencing and screening to be installed promptly upon completion of clearing and grading.

(3) Parking areas shall be so designed as to minimize to the extent practicable the number of parking spaces situated in a continuous row. Landscape plans submitted as a part of the final plans for any improvements on Map Section K shall include interior landscaping trees within

parking areas at an aggregate of one (1) tree for every fifteen (15) parking spaces, provided that the distance between trees may be varied or offset on adjacent rows of parking in order to break up the field of vision and obtain a less rigid look, provided that the number of parking spaces between interior landscaping trees shall in no case exceed 20 parking spaces. Notwithstanding the foregoing, in connection with its review and approval of final plans for any improvements, the Commission may approve, at its option, an alternative landscape plan that varies from this requirement, but one which the Commission concludes will provide an aesthetically pleasing landscape arrangement. Except as may be approved by the Commission in connection with its review and approval of final plans, parking and maneuvering areas shall not be located within twenty feet of private roads or public rights-of-way, except where private roads serve as access drives for such parking, nor within fifty (50) feet of the rights-of-way of Chippenham Parkway and its access ramps. If Northern Map Section L is used for multi-family residential use, parking and maneuvering areas within Northern Map Section L may be located within twenty-five (25) feet of the rights-of-way of Chippenham Parkway and its access ramps. All parking areas and areas devoted to service and trash collection shall be suitably screened from ground level view from (i) adjacent public streets, (ii) all residentially zoned properties adjacent to perimeter buffers of 100 feet or greater in width but less than 150 feet in width and (iii) single-family development within Map Section A-1, by evergreen vegetation, opaque structural material or other means which may be approved by the Commission. The terms of this Section 1(B)(3) shall not apply to Map Section M.

(4) All parking areas, access-aisles, and driveways shall be paved with a dust free, all-weather surface and parking spaces shall be delineated.

(5) All costs related to right-of-way acquisition and the extension of utilities and roads to serve the development shall be borne by the owners, except to such extent as the City may agree to participate in the cost thereof. Electric power and telephone lines shall be located underground wherever practicable.

(6) Rights-of-way for all public streets may be dedicated to the City at no cost, and shall be of such width, alignment and character as approved by the Commission.

(7) No access to or from Map Sections K or L shall be provided from adjacent residential streets, including Cherokee Road, Saratoga Road, Yuma Road, Cheyenne Road, Apache Road, Twin Valley Road or any of the existing streets located adjacent to the southern boundary of Map Section L, except for emergency access to Evansway Lane or Bittersweet Road if deemed necessary by the City.

(8) Emergency access to the property shall be provided at the developers' expense and in a manner acceptable to the Chief of Police and the Chief of Fire and Emergency Services, and the Departments of Parks, Recreation and Community Facilities, Public Works and Planning and Development Review, and, except for emergency access to Map Section M which shall be as provided for in Section 1(B)(10) of this Ordinance, shall be located generally as shown on the Development Plan dated October 22, 2014. The precise location of the connection of such emergency access to the extension of Stony Point Parkway shall be detailed on the final plans for the extension of Stony Point Parkway.

(9) All Streets within Southern Map Section M shall be privately owned and maintained by the homeowners' association. The pavement surface for all Streets and Fire Apparatus Access Roads shall be a minimum of eighteen (18) feet in width; and for all Shared Driveways or portions thereof which are not designated as Fire Apparatus Access Roads, shall be

a minimum of twelve (12) feet in width. In any areas along Fire Apparatus Access Roads, where parking is to be permitted an additional eight (8) feet of pavement shall be provided (the “Parking Lane”). The front to rear grade of all Fire Apparatus Access Roads shall be a maximum of twelve percent (12%). The front to rear grade of all Streets, or portions thereof which are not designated as Fire Apparatus Access Roads, shall be a maximum of sixteen percent (16%). Turning radii at the corners and load-bearing characteristics of all Fire Apparatus Access Roads shall meet the requirements of the VSFPC. Fire hydrants shall be placed at locations as required by the VSFPC. Street lighting and sidewalks shall not be required within Map Section M but, if installed, shall be maintained by the homeowners’ association as a part of Common Areas.

(10) Vehicular Access to Southern Map Section M:

(a) There shall be one (1) unrestricted access point between Southern Map Section M and Cherokee Road, generally as depicted on the Development Plan dated October 22, 2014, which access point shall serve as the only regular vehicular access point to Southern Map Section M (the “Cherokee Road Access”). At the option of the owners of Southern Map Section M, the Cherokee Road Access may be gated so as to permit access only by residents of dwellings or owners of property within Southern Map Section M, their guests and invitees.

(b) In addition to the Cherokee Road Access, there shall be one (1) gated emergency and recreational access to Southern Map Section M which connects the Streets within Southern Map Section M with the existing fire lanes, emergency access roads, or streets within Map Section E (the “Restricted Access”), which access shall at all times following issuance by the City of the first certificate of occupancy for a dwelling unit constructed within the Southern Map Section M (the “C.O. Date”) be limited to (i) golf carts and similar low-speed vehicles and bicycles of residents of dwellings or owners of property within Southern Map Section M, their guests and

invitees, (ii) emergency vehicles, (iii) pedestrians, and (iv) regular vehicular ingress and egress between Southern Map Section M and Stony Point Parkway when and only when Cherokee Road is closed to regular vehicular traffic by any governmental authority.

(c) Following the C.O. Date, the Restricted Access shall be gated, which gate shall remain closed at all times except when being used for the authorized uses provided herein. The means of gating and access control, including access for emergency vehicles, shall be approved by the Commission at the time of its approval of the tentative subdivision plat(s) for Map Section M so as to conform to this requirement.

(d) At no time shall any of the Streets (Public or Private) within Southern Map Section M or the Restricted Access be used by the general public to gain vehicular access between Cherokee Road and Stony Point Parkway.

(e) Prior to the C.O. Date construction traffic may access Southern Map Section M only via the Restricted Access and such traffic shall not access Southern Map Section M via Cherokee Road, except when such traffic is associated with: (i) initial construction of the Restricted Access; (ii) construction of the Cherokee Road Access; (iii) construction, installation or extension of any utilities in the vicinity of Cherokee Road; or (iv) construction work within portions of Southern Map Section M which, due to terrain or other conditions, is reasonably more accessible from Cherokee Road than from within Southern Map Section M. There shall be a temporary gate installed and maintained at the Cherokee Road Access to ensure that construction phasing establishes regular construction access via the Restricted Access and to conform with the requirements of this Section 1(B)(10).

(f) No provision of this Ordinance shall restrict use of that easement dated October 4, 1917 and recorded October 29, 1917 in the office of the Clerk of the Circuit Court of Chesterfield

County Virginia in Deed Book 134 Page 178 that provides access across the northwest corner of Southern Map Section M only between Cherokee Road and that property situated to the west of Southern Map Section M, known as 9307 Cherokee Road and identified as Tax Parcel No. C001/0374-024, or any amendment thereto.

(11) There shall be one point of vehicular access from Cherokee Road into Northern Map Section M. At all times, vehicular access between Northern Map Section M and Cherokee Road shall be restricted so as to permit vehicular access only by residents of dwellings or owners of property within Map Section M, their guests and invitees, and emergency vehicles.

(12) All areas indicated on the Development Plan dated October 22, 2014, as buffers shall be left in their natural state, except for any clearing necessary for utility lines, drainage facilities or means of access approved by the City, provided (i) any such access shall be subject to the limitations of Section 1(B)(7) of this ordinance and (ii) supplemental planting shall be provided in accordance with plans approved by the Commission to reasonably address the impact of any such clearing other than clearing for emergency access required by the City. Where required buffers are less than 125 feet in width, if existing vegetation does not provide an effective visual screen from adjacent property, supplemental planting and/or fencing shall be provided in accordance with plans approved by the Commission. Installation of the evergreen trees and fencing, as applicable, as provided in Section 1(B)(2) and Section 1(A)(10)(k) of this ordinance, shall be sufficient to comply with the requirements of this paragraph as to any development within Map Section K and the applicable portions of Map Section L.

If Northern Map Section L is used for multi-family residential use, the owner of Northern Map Section L, for a period of one (1) year from the date the certificate of occupancy is issued for the last residential building on Northern Map Section L, shall replace dead or diseased trees located

within the Perimeter Buffer adjacent to the property lines of Northern Map Section L, upon the written request of the owner of property immediately adjoining the portion of the Perimeter Buffer along the property line of Northern Map Section L, as approved by the City Arborist, with a new deciduous tree having a caliper of not less than 2.5 inches at the time of installation, measured six (6) inches above the ground, or an evergreen tree having a height of not less than eight (8) feet at the time of installation for every removed tree, at the earliest appropriate planting season.

(13) Existing topography and all healthy trees shall be retained wherever practicable, and appropriate measures shall be taken to prevent soil erosion during and after construction. There shall be no clearing or grading in any area until after final detailed grading plans for such area are approved. Except as necessary for development of Map Section K (including construction of drainage and utility facilities serving Map Section K and located outside of Map Section K) and the construction of the extension of Stony Point Parkway, no clearing shall occur on Map Section L prior to commencement of development of Map Section L pursuant to an approved final plan. Selective thinning and clearing of trees in Map Section M shall be permitted to ensure river views from the dwellings to be built within Map Section M.

(14) The owner of Map Section E shall, at such time as may be requested in writing by the City, convey by easement or in fee simple (as determined by the City) to the City for public purposes and at no cost to the City a strip of land not more than one hundred fifty (150) feet in width and lying within Map Section E, adjacent and parallel to the eastern boundary of that portion of Map Section E lying north of the present City-owned property. Notwithstanding such conveyance, the aforesaid strip of land shall continue to be included as part of Map Section E for purposes of determining maximum development, maximum density, minimum gross open space, minimum livability space and all applicable buffer areas.

(15) The owner of Map Section M shall, at such time as may be requested in writing by the City, convey by easement or in fee simple (as determined by the City) to the City, to allow the City to increase the radius of the curve in the right-of-way of Cherokee Road and at no cost to the City, a strip of land lying within Map Section M and generally located between “Line E” as shown on the Development Plan dated October 22, 2014, and the existing right-of-way of Cherokee Road. “Line E” shall be shown on the subdivision plat(s) for Map Section M. Notwithstanding such conveyance, the aforesaid strip of land shall continue to be included as part of Map Section M for purposes of determining any applicable development standards including setbacks, buffers, maximum development and maximum density.

(16) A minimum of twenty percent (20%) of the total area lying within Map Sections D, E and F, as shown on the Development Plan dated October 22, 2014, and a minimum of thirty percent (30%) of the total area lying within Map Section L, as shown on the Development Plan dated October 22, 2014, shall be left in a natural or undisturbed state with no material removal of mature vegetation or material alteration of existing grades.

(17) The boundary lines between Map Sections on the Development Plan dated October 22, 2014, may be adjusted, or any map section may be subdivided into separate development parcels, thereby increasing or decreasing maximum permitted development within a particular map section, provided that the development standards applicable to any map section so modified shall be applied proportionately and provided further that the total amount of permitted development on the property is not increased. Notwithstanding the foregoing, in the event of any adjustment in the acreage of Map Sections K and L, no such adjustment shall increase or decrease the maximum development permitted within such Map Sections.

(18) Signage for Map Sections D, E, and F:

A final comprehensive signage program for Map Sections D, E and F setting forth details relative to sign types, numbers, materials, construction, lighting, heights, areas and setbacks shall be submitted to and approved by the Commission prior to the erection of any permanent identification signs on Map Sections D, E or F. The principal objectives to be incorporated into such program shall be substantially in accordance with objectives set forth in the report entitled "Preliminary Signage Concept Program for Stony Point", prepared by Wallace Roberts and Todd and revised November 22, 1985, a copy was attached to and made a part of Ordinance No. 85-315-290. The specific standards to be incorporated into the final comprehensive signage program for Map Sections D, E and F or any amendment thereto shall be no less restrictive than those set forth in the design guidelines contained in the aforementioned report.

In the implementation of the final comprehensive signage program for Map Sections D, E and F, the Commission shall not approve any sign that does not conform to the standards set forth therein, provided, however, the Commission shall have the authority to authorize a sign which exceeds the area and height limitations by no more than twenty-five percent (25%) when the Commission determines that such greater area or height is necessary to achieve adequate identification due to exceptional topographic conditions, site layout, road alignment or grades, or to preserve natural features of the site. Any deviation from the sign area or height limitations shall be consistent with the general objectives of the preliminary and final signage programs.

In addition to the signage provided for in the final comprehensive signage program for Map Sections D, E and F, additional building-mounted signage may be permitted on the office and/or medical use buildings within Map Sections D, E and F in accordance with the objectives set forth in the report entitled "Building-Mounted Signage Guidelines", prepared by Charter Properties, Inc. and dated November 1, 1994, a copy of which was attached to and made a part of Ordinance No.

94-289-95-3. The actual details relative to sign types, numbers of signs, materials, construction, lighting, location and height, area, and orientation for each building shall be subject to the final plan review. The Director of Planning and Development Review shall be authorized to review and approve or disapprove such final plans in lieu of Commission review and action. Any final plan submitted under this section that is disapproved by the Director shall, at the request of the applicant, be submitted to the Commission for its review. Request for such review shall be made in writing to the Secretary of the Commission within thirty (30) days of the disapproval of the plan by the Director. After reviewing the plan, the Commission may affirm the decision of the Director of Planning and Development Review, or, upon a finding that the plan conforms to the guidelines contained in the report attached to Ordinance No. 94-289-95-3, the Commission may instruct the Director to approve the plan as it deems necessary to ensure conformance with said guidelines. The action by the Commission shall be by formal resolution approved by a majority of the members. The specific standards incorporated into any final plan approval for development within Map Sections D, E or F, whether by the Director or by the Commission, shall be no less restrictive than those set forth in the objectives contained in the aforementioned report.

(19) Signage for Map Section M: the following signage shall be permitted for Map Section M:

(a) At the Cherokee Road Access Point: one freestanding sign not exceeding sixteen (16) square feet in area and four (4) feet in height and not located within five (5) feet of the public street right-of-way of Cherokee Road.

(b) Signs located within Map Section M which are not visible from public streets shall not be regulated by this Ordinance.

(c) One (1) temporary marketing sign not exceeding sixteen (16) square feet in area and four (4) feet in height and not located within five (5) feet of the public street right-of-way of Cherokee Road shall be permitted, at the Cherokee Road Access Point. Such sign must be removed upon issuance of the building permit for the last dwelling as shown on the subdivision plat for Map Section M.

(20) Signage for Map Sections K and L: A final comprehensive signage program for Map Sections K and L setting forth details relative to sign types, numbers, materials, construction, lighting, heights, areas and setbacks shall be submitted to and approved by the Commission prior to the erection of any permanent identification signs on Map Sections K or L. The actual details relative to sign types, numbers of signs, materials, construction, lighting, location and height, area, and orientation for each building shall be subject to the final plan review. The Director of Planning and Development Review shall be authorized to review and approve or disapprove such final plans in lieu of Commission review and action. Any final plan submitted under this section that is disapproved by the Director shall, at the request of the applicant, be submitted to the Commission for its review. Request for such review shall be made in writing to the Secretary of the Commission within thirty (30) days of the disapproval of the plan by the Director. After reviewing the plan, the Commission may affirm the decision of the Director of Planning and Development Review, or, upon a finding that the plan conforms to the approved comprehensive signage program for Map Sections K and L, the Commission may instruct the Director to approve the plan as it deems necessary to ensure conformance with said guidelines. The action by the Commission shall be by formal resolution approved by a majority of the members.

(21) For each portion of the property shown on the Development Plan dated October 22, 2014, other than Map Sections A-1, K and L, a site plan and architectural review committee shall

be established by the owners of the property, which committee shall, by covenant, have the authority to approve or disapprove the character and design of final plans for all nonpublic elements of the Development Plan dated October 22, 2014, within the applicable portions of the property. It shall be a stated responsibility of each such committee to require that conditions imposed by the City, as well as those established by the owners of the property served by such committee, are met in the detailed design of each section of the Development Plan dated October 22, 2014.

(22) The owner(s) of Map Sections K and L shall establish a development review committee for Map Sections K and L. The committee shall be advisory to the owner of Map Sections K and L and shall review all site plans, architectural elevations, building materials, fencing, screening and lighting for development within Map Sections K and L. The committee shall also review issues relating to water quality, run-off, land clearing methods and minimization of construction impacts on adjacent residents. The committee shall offer to allow one representative each of the Huguenot Farms Area Association, the Cherokee Area Neighbors, the Saratoga Area Neighborhood Association and the Fernleigh Neighborhood Association to serve on the committee.

(23) Reserved.

(24) Final detailed plans, including site plans, traffic impact studies as provided in (26) below, typical floor plans, elevation drawings, landscaping plans and grading, drainage, and utility plans for each phase of the development shall be submitted to and approved by the Commission prior to the issuance of the first permit for such phase. The Commission shall, by formal resolution, approve such plans if it finds them to be consistent with the objectives of the Development Plan dated October 22, 2014, and not in conflict with any of the standards, conditions and terms

specified herein. Otherwise, the Commission shall not approve such plans. In the case of single-family detached development, approval of tentative subdivision plats by the Commission, and Commission review of covenants and restrictions to be applicable within such subdivisions shall constitute approval of final detailed plans, and additional plans shall not be required to be approved by the Commission. The first building permit for each phase of development shall be requested within eighteen (18) months of the date of Commission approval of final plans for such phase, otherwise, such final approval shall be considered null and void. Plans submitted for building permit approval shall be substantially in conformance with the plans approved by the Commission.

(25) All plants, trees and other landscaping materials installed within portions of Map Sections K and L pursuant to approved landscaping plans shall be maintained by the owner of the property on which such materials are located.

(26) Except as otherwise provided herein, in conjunction with submission for final plan approval for each phase of the development, the owner shall submit a traffic impact study for the phase in question prepared by a professional traffic engineer. Such study shall be conducted in a manner acceptable to the City's Traffic Engineer, and in accordance with procedures and definitions set forth in the report entitled "Interim Materials on Highway Capacity," Transportation Research Circular No. 212, National Academy of Sciences, January, 1980. Such study shall identify the projected traffic impact of the phase in question as of the projected date of completion and occupancy of said phase. The study shall identify the current conditions and the projected traffic impact on the following roadways, interchanges and intersections:

(a) Principal points of access from development sites to Stony Point Parkway and Chippenham Parkway, as determined by the Director of Public Works;

(b) The segment of Chippenham Parkway through the Stony Point site and its interchanges and/or intersections with Stony Point Parkway and Huguenot Road;

(c) The segments of Huguenot Road between Forest Hill Avenue and Cherokee Road, including the intersections with Forest Hill Avenue, Stony Point Road, and Cherokee Road; and

(d) The segment of Chippenham Parkway between Huguenot Road and Forest Hill Avenue and its interchange and/or intersections with Forest Hill Avenue, but excluding its intersection with Custis Road and any other intersection at which a traffic signal may be installed after May 24, 1995.

Traffic impact studies shall not be required for (i) Map Sections A-1 or M of the Development Plan dated October 22, 2014, (ii) the land within Parcel B on Plat 2, (iii) modification of a previously approved final plan where not more than ten thousand additional square feet of occupiable building area are proposed by such modification or (iv) Map Sections K and L, subject to the conditions set forth in the following paragraph.

The Commission shall not grant any final plan approval unless it is satisfied, after receiving a report from the City's Traffic Engineer relative to the conclusions of the traffic impact study, that the aggregate of the traffic projected to be generated by the phase or phases of development in question and the traffic generated or projected to be generated by all previously approved phases of development will not, as of the projected date of completion and occupancy of such phase or phases, cause the levels of service on any of the aforementioned roadways, interchanges and intersections during the a.m. and p.m. peak hours to fall below level of service "C" or, for turning movements at such intersections and/or interchanges, level of service "D". In conducting such evaluation, the City Traffic Engineer and the Commission shall, to the extent required to avoid an adverse conclusion as to the proposed development, disregard any traffic signals existing within

the road segment described in paragraph 4 above and any road improvements made after July 24, 1995. By its adoption of this Ordinance, Council acknowledges that the traffic impact study submitted in connection with the approval of the deletion of Map Section J, as shown on the 1999 Development Plan, and the addition of Map Sections K and L as reviewed by the City Traffic Engineer (the “2001 Traffic Impact Study”), satisfy all requirements of this paragraph relating to traffic study submission requirements with respect to all development within Map Sections K and L authorized by this Ordinance as long as the total traffic generated by uses within such map sections does not exceed either a total of not more than 1,280 in bound and out bound A.M. peak hour trips or a total of not more than 2,975 in bound and out bound P.M. peak hour trips as measured in accordance with the table attached to this Ordinance entitled “Trip Generation Table”.

The Commission shall not grant final plan approval for any phase of the development until it is satisfied that any road improvements proposed by the City Traffic Engineer in reports provided pursuant to the foregoing paragraph and deemed necessary by the Commission to avoid the reductions in levels of service as set forth herein are reasonably projected to be completed prior to or at the projected date of completion and occupancy of the development phase in question. The Commission shall attach such conditions to its final plan approval as it deems necessary to ensure compliance with the provisions of this section.

Notwithstanding the foregoing, installation of the traffic control devices at (i) the intersection of Stony Point Parkway and the entrance ramp to the northbound lanes of Chippenham Parkway and (ii) the intersection of Stony Point Parkway and the entrance ramp to the southbound lanes of Chippenham Parkway which the Commission determines or has determined will be necessary to achieve required improvement in the levels of service shall not be required prior to the issuance of certificates of occupancy for improvements within the Northern Portion so long as

an agreement, in form approved by the City Attorney, has been entered into among Stony Point Limited Partnership II, Virginia Commonwealth University Health System Authority, University Health Services, Inc., Highwoods Properties Limited Partnership and C & T Stony Point III, LLC, or their successors in title, owners of all of the land located within the Northern Portion, and the City establishing the agreement of such owners to pay for the installation of the required traffic control devices at such time as the warrants for the traffic control devices are met, as determined by the Director of Public Works, if the City does not elect to provide funding for the installation of the traffic control devices.

(27) Notwithstanding anything to the contrary contained in this Ordinance, (i) floor area ratio and density limitations shall be applied to each map section as a whole and (ii) land area to satisfy floor area ratio and density limitations associated with any permitted use may be located within areas designated for other uses provided that such areas designated for other uses are located within the same map section, that such land area is located on a parcel of land that is contiguous with the parcel of land containing the use and that there are no improvements located within such areas.

(28) Upon denial of any final plan approval by the Commission under the provisions of this section, or upon the expiration of the time permitted for submittal of final plans, the owner shall be entitled to develop the property in question in a manner that conforms with the regulations, restrictions and procedures prescribed in the City Code for the zoning district classification of such property as shown on the official zoning map of the City as of the date of such denial.

§ 2. SOUTHERN PORTION OF THE TRACT

That pursuant to Section 17.10(g) of the Charter of the City of Richmond, and Article IV of Chapter 30 of the Code of the City of Richmond [~~(2015)~~ (2020)], as amended, the development

of the southern portions of the tracts containing an aggregate of 135.74 acres and consisting of parcels 1, 2, and 4 shown on Plat 1, a copy of which is attached to Ordinance No. 87-198-187, and the parcel shown on Plat 1-A, a copy of which is attached to Ordinance No. 88-264-239, for the development of approximately 127,000 square feet of shopping center space, 150,000 square feet of office space, one church, up to 59 single-family attached dwelling units, 366 apartment and retirement dwelling units, 105 condominium units and related restaurant, filling station, medical, financial, office, retail, day care facilities, parking and other attendant facilities generally in accordance with a site plan entitled “Stony Point”, prepared by Clower Associates, Inc. , dated October 5, 1983, and revised December 23, 1983, and as modified with regard to Map Sections F, J, M and P by the plan entitled “A Community Unit Plan, Stony Point, Richmond, Virginia”, prepared by the Woolfolk Companies and dated August 15, 1988 (reference in this § 2 to “map section” or “parcels” refer to Map Sections or parcels as shown on plans prepared by Clower Associates, Inc., and The Woolfolk Companies and are sometimes referred to as the “1988 Development Plan”), and as modified with regard to Map Section K by the plan entitled “Stony Point, Community Unit Plan,” prepared by Youngblood, Tyler & Associates, P.C., dated May 1, 2018, and last revised October 22, 2018 (the “2018 Development Plan”), and the sketches showing the general character of the shopping center and adjacent commercial parcels prepared by GNA Architects and dated December 15, 1983, which are attached to ordinance No. 84-11-13, and the sketches showing the general character of “The Bluffs at Stony Point” and the office building on map Section F which are attached to Ordinance No. 88-264-239, and the plans entitled “Stony Point Shopping Center Signage Options” prepared by Glavé & Holmes Architecture, and dated October 5, 2016 and “ALTA/ACSM Land Title Survey Showing 11.093 Acres of Land Lying North of Huguenot Road, State Route 147 (Being Lot 5 Block A of Stony Point), Known as Stony

Point Shopping Center,” prepared by Glavé & Holmes Architecture, and dated October 27, 2014, copies of which are attached to Ordinance No. 2017-227, adopted December 11, 2017, and the plans entitled “Stony Point Landing, Conceptual Layout,” “Stony Point Landing, Landscape Buffer Plan,” and “Stony Point Landing, Common Area Amenities,” all prepared by Youngblood, Tyler & Associates, P.C., dated March 7, 2018, and last revised October 16, 2018, copies of which are attached to ~~[this amendatory ordinance]~~ Ordinance No. 2018-304, adopted January 14, 2019, is hereby approved and permitted upon the following standards, conditions and terms:

A. Development standards:

(1) Shopping Center (Map Section E)

(a) Maximum floor area ratio: .20.

(b) Minimum non-vehicular open space: 33% of site.

(c) Maximum Height: 2 stories.

(d) Minimum off-street parking: 5 spaces per 1, 000 square feet of gross leasable area.

(e) Sign restrictions: signage shall be restricted to that allowed in the B-1 zoning district, as set forth in the Code of the City of Richmond [~~(2015)~~] (2020), as amended, with the exception that tenants of the shopping center who occupy in excess of thirty-five thousand (35,000) square feet of gross leasable area shall be permitted up to two hundred (200) square feet of permitted sign area, provided that no freestanding signs shall be permitted.

(2) Office (Map Sections F, G and O)

(a) Maximum floor area ratio: .20.

(b) Minimum open space ratio: 4.0.

(c) Minimum livability space ratio: .5

(d) Maximum height: 2 stories.

(e) Minimum off-street parking: one space per 300 square feet of gross leasable area for Map Sections G and O, and one space per 400 square feet of gross leasable area for Map Section F.

(f) Sign restrictions: freestanding signs not exceeding 16 square feet in area or 6 feet in height shall be permitted at major public entrances to the complexes. One such sign shall be permitted for Map Section F. Other signs shall conform to the provisions of Section 30-424.3 of the Code of the City of Richmond [~~(2015)~~] (2020), as amended.

(3) Multi-family and Retirement Village (Map Sections I and L):

(a) Floor area, open space and livability space ratios, yards and spaces between buildings, and off-street parking requirements shall be as set forth in Chapter 30 of the Code of the City of Richmond [~~(2015)~~] (2020), as amended, and as applicable to the R-43 Multi-Family Residential District. Maximum densities shall be as shown on the 1988 Development Plan.

(b) Maximum height: 2-1/2 stories.

(c) Sign restrictions: freestanding signs not exceeding 16 square feet in area and 6 feet in height shall be permitted at each public entrance to the complexes.

(4) Multi-Family Condominiums (Map Sections M and P on Plan dated August 15, 1988):

(a) Floor area, open space and livability space ratios, yard and spaces between buildings, and off-street parking requirements shall be as set forth in Chapter 30 of the Code of the City of Richmond [~~(2015)~~] (2020), as amended, and as applicable to the R-43 Multi-Family Residential District. Maximum number of units shall not exceed 52 in Map Section M and 53 in Map Section "PI".

(b) Maximum height: 3 stories.

(c) Sign restrictions: one freestanding sign not exceeding 16 square feet in area and 6 feet in height shall be permitted at the public entrance to the complex, but not within 5 feet of the public street right-of-way.

(d) Buildings containing dwelling units shall be located not less than 15 feet from internal roadways and parking area.

(e) A minimum 25-foot buffer shall be provided on the perimeter of the site adjacent to City-owned park land.

(f) Temporary construction access to Parcel P shall be by way of the emergency access route provided for Parcel M.

(5) Church and Day Care Center (Map Sections N and part of M):

(a) All development standards applicable to such uses in the R-6 Single-Family Attached Residential District shall apply, provided that building setbacks, yards, parking and circulation arrangements and other site plan elements shall be as approved by the Commission, and provided further that signage for the day care center shall be limited to one freestanding sign not exceeding three and one-half feet in height and six square feet in area (plus a base not exceeding six square feet in area) to be located within the median of the entrance drive to the site.

(b) No day school (weekday) educational programs shall be conducted in conjunction with the use of the church sites.

(6) Parcels "A", "B", "C", and "D":

(a) Uses of these parcels shall be as indicated on the 1988 Development Plan, provided there shall be no servicing or repair of vehicles, other than auto washing and normal activities conducted at pump islands, in conjunction with site "D".

(b) There shall be no parking areas located between the buffer strip and buildings to be constructed on sites “A”, “B”, “C” and “D”, and all non-parking paved areas between such buildings and the buffer shall be the minimum necessary to enable essential on-site circulation.

(c) Signage for uses on parcel “A” through “D” shall be limited as set forth in the B-1 Neighborhood Business District, provided that (i) one freestanding sign not exceeding 16 square feet in area and 6 feet in height shall be permitted for each site and shall not be oriented toward Huguenot Road and (ii) one freestanding sign on Parcel “A” and one free standing sign on Parcel “D” shall be permitted, substantially as shown on the plans entitled “Stony Point Shopping Center Signage Options” prepared by Glavé & Holmes Architecture, and dated October 5, 2016 and “ALTA/ACSM Land Title Survey Showing 11.093 Acres of Land Lying North of Huguenot Road, State Route 147 (Being Lot 5 Block A of Stony Point), Known as Stony Point Shopping Center,” prepared by Glavé & Holmes Architecture, and dated October 27, 2014, copies of which are attached to Ordinance No. 2017-227, adopted December 11, 2017. The signs shall not exceed an individual area of 175 square feet and a height of 16 feet. Such signs may be internally or externally illuminated. If externally illuminated, the source of illumination shall be ground-mounted and not visible from the adjacent streets. Landscaping of the signs shall be approved by the Director of Planning and Development Review.

(d) Parking requirements for such sites shall be as set forth in Chapter 30 of the Code of the City of Richmond [~~(2015)~~ (2020)], as amended.

(e) All other development standards applicable to section “E” of the 1988 Development Plan shall apply to these sites, provided that the non-vehicular open space requirements shall not apply to site “D”. Unless otherwise specified herein, all definitions and methods of calculation

relative to these development standards shall be as set forth in Chapter 30 of the Code of the City of Richmond [~~(2015)~~] (2020), as amended.

(7) Project Identification Signs:

Not more than two signs identifying “Stony Point” may be located within the 100-foot buffer area along Huguenot Road, one each at the northwest corners of Stony Point Road and Huguenot Road, and Forest Hill Avenue and Huguenot Road, but not within twenty feet of any street right-of-way. Such signs shall consist of decorative field stone walls with landscaping at the base, each not exceeding sixty square feet in area, twenty-one feet in length and four feet three inches in height, with a message area consisting of the name of the development not exceeding seven square feet in area. Such signs may be illuminated, provided the source of illumination is ground-mounted and not visible from the adjacent streets.

(8) Single-Family Attached Residential Dwellings (Map Section K)

(a) Development of Map Section K shall be in substantial conformance with the 2018 Development Plan and the plans entitled “Stony Point Landing, Conceptual Layout,” “Stony Point Landing, Landscape Buffer Plan,” and “Stony Point Landing, Common Area Amenities,” all prepared by Youngblood, Tyler & Associates, P.C., dated March 7, 2018, and last revised October 16, 2018, copies of which are attached to [~~this amendatory ordinance~~] Ordinance No. 2018-304, adopted January 14, 2019.

(b) There shall be no more than 59 dwelling units within Map Section K and no more than five units shall be attached in a series, substantially as shown on the plans referenced in section 2(A)(8)(a).

(c) Dwelling units shall be located on lots of no less than 1,450 square feet in area.

(d) Building height shall be limited to 38 feet, in accordance with the applicable provisions of the Code of the City of Richmond [~~(2015)~~] (2020), as amended.

(e) There shall be a front yard with a depth of not less than 15 feet and a rear yard with a depth of not less than 10 feet. There shall be side yards of not less than 7 feet except where buildings are attached.

(f) Each dwelling unit shall have a one-car garage and a driveway sufficient for the parking of one vehicle within the residential lot on which the dwelling is located. Additional site parking shall be provided substantially as shown on the plans referenced in section 2(A)(8)(a).

(g) Units with front loaded garages shall use an upgraded garage door. For the purposes of this ordinance, an upgraded garage door is any door with a minimum of two enhanced features, one of which must be the incorporation of at least one window insert. Enhanced features shall also include: raised panels, decorative panels, arches, hinge straps, or other architectural features on the exterior that enhance the entry (i.e., decorative lintels, shed roof overhangs, arches, columns, keystones, eyebrows, and the like). Flat panel garage doors shall be prohibited.

(h) Street trees shall be provided in the locations generally shown on the plans referenced in section 2(A)(8)(a) at a minimum of one and one-half inches in caliper size at the time of planting, unless the Commission approves changes in connection with final plan approval.

(i) Sidewalks and pedestrian paths shall be installed substantially as shown on the plans referenced in section 2(A)(8)(a). Each unit shall have a leadwalk in the front yard connecting the driveway to the front stoop or front door as generally shown on the plans referenced in section 2(A)(8)(a), except that Units 52 through 59 as shown on the plans referenced in section 2(A)(8)(a) shall have a leadwalk in the front yard connecting the front stoop or front door with the sidewalk as generally shown on the plans referenced in section 2(A)(8)(a).

(j) Two bike racks shall be installed within Map Section K, with a minimum total capacity of 18 bicycles.

(k) A decorative lamp post shall be provided for each dwelling unit, located within the front yard as generally shown on the plans referenced in section 2(A)(8)(a).

(l) Signage in Map Section K shall be limited to (i) signage permitted in all districts pursuant to section 30-505 of the Code of the City of Richmond (2015), as amended, and (ii) one freestanding sign not exceeding ten feet in height and 25 square feet in area, located substantially as shown on the plans referenced in section 2(A)(8)(a). Such sign may be illuminated, provided that the source of external illumination is ground-mounted.

(m) A landscape strip, at least 19 feet wide, containing no fewer than 48 shrubs, six small trees, and 11 large trees, shall be provided on Map Section K along Forest Hill Avenue, substantially as shown on the plans referenced in section 2(A)(8)(a).

(n) A buffer a minimum of 25 feet in width shall be provided along Evansway Lane, and the 100 foot buffer along the western boundary line of Map Section K, shown on the Southern Portion and as illustrated on the 1988 Development Plan, shall be reduced to a minimum of 50 feet in width along the western boundary of Map Section K, substantially as shown on the plans referenced in section 2(A)(8)(a). The trees and shrubs contained within the 25 foot and 50 foot wide buffer areas shall meet a minimum requirement of one tree every 20 linear feet and one shrub every ten linear feet. Existing trees and shrubs within the 25 foot and 50 foot wide buffer areas shall be retained and credited toward the minimum required landscaping for the 25 foot and 50 foot wide buffer areas with existing trees being credited toward both the minimum required trees and shrubs; provided, however, that existing vegetation may be removed (i) if fallen, diseased or dead, (ii) to the extent necessary or allowed for existing utility easements and related

improvements, including sewer and drainage, that pass through the buffers in their existing manner, (iii) for the installation and maintenance of a pedestrian connection to the sidewalk along Evansway Lane through the 25 foot buffer, substantially as shown on the plans referenced in section 2(A)(8)(a), and (iv) any other purpose or purposes requested and specifically approved at the time of final plan review. Notwithstanding such removal, the minimum landscaping standard shall continue to be met and additional trees or shrubs planted in the buffer if necessary to continue to meet the minimum landscaping standard. The 25 foot and 50 foot buffers shall be included in the common area owned by the homeowner's association formed under the Covenants (defined in section 2(A)(8)(s) below). There shall be no vehicular access through the 25 foot wide buffer along Evansway Lane.

(o) A row of evergreen shrubs, such as Leland Cypress or similar species, shall be planted along the 25 foot and 50 foot buffers, substantially as shown on the plans referenced in section 2(A)(8)(a). Such evergreen shrubs shall be planted at an initial height of five feet, and the spacing shall be determined at the time of final plan review based upon the species used, as approved by the Urban Forestry Division of the Department of Public Works.

(p) Supplemental plantings of the type noted in the Landscape Legend on the plans referenced in section 2(A)(8)(a) shall be provided in the common area in the general locations shown on the plans referenced in section 2(A)(8)(a), unless the Commission approves changes in connection with final plan approval.

(q) Foundation planting beds, a minimum of three feet deep, shall be required along the entire front façades of each building, excluding areas for the leadwalk, stoops, driveways and any entryways to porches, patios and garages. Planting beds shall initially contain a minimum of 50 percent evergreen materials and shall include two or more of the following types of materials

for visual interest: groundcover, small shrubs, large shrubs, and small trees. House corners shall initially be visually softened with vertical accent shrubs (four feet to five feet at maturity) or small evergreen trees (six feet to eight feet at maturity).

(r) At a minimum, the common area shall include the following recreational amenities: the tot lot and the fire pit seating area in the general design shown on the plans referenced in section 2(A)(8)(a) of this amendatory ordinance. These amenities shall be provided in the general location noted on the plans referenced in section 2(A)(8)(a). In addition, the stormwater pond shown on the plans referenced in section 2(A)(8)(a) shall be aerated.

(s) Prior to or concurrent with the recordation of a subdivision plat approved by the City and before the conveyance of a lot shown on said subdivision plat (other than for the dedication of easements, roads or utilities), a document shall be recorded in the Clerk's Office of the Circuit Court of the City of Richmond, setting forth controls on the development and maintenance of the property shown on said subdivision plat (the "Covenants"). The Covenants shall include provisions for maintenance and operation of any stormwater management system and the recreational amenities in the common area, and address aesthetic design principles of homes, specific architectural design guidelines, landscaping and maintenance of the 25 foot and 50 foot buffers. The Covenants shall also establish standards for fencing on individual lots shown on said subdivision plat. No chain-link, mesh or barbed-wire fencing will be permitted.

B. Conditions Applicable to 1988 Development Plan and 2018 Development Plan:

(1) Development standards for individual sections of the Plan shall be as set forth in subsection A above.

(2) Parking areas shall be so designed as to result in no more than 15 parking spaces being situated in a continuous row. Parking areas shall not be located within 20 feet of private or

public roads, except where private roads serve as access drives for such parking, with the exception of Map Section K. All parking areas and areas devoted to service and trash collection shall be screened from view from adjacent public streets and residential areas. Within Map Section K, screening of parking areas shall be provided by the landscape strip and the buildings facing Forest Hill Avenue and the 25 foot and 50 foot buffers, substantially as shown on the plans referenced in section 2(A)(8)(a).

(3) All parking areas, access-aisles, and driveways shall be paved with dust-free, all-weather surface and parking spaces shall be clearly identified on the pavement surface.

(4) All costs related to extension of utilities and roads to serve the development shall be borne by the owners, except to such extent as the City may agree to participate in cost sharing pursuant to normal City policy relative to utilities and roads serving non-residential development.

(5) Rights-of-way for all public streets shall be dedicated to the City at no cost. The rights-of-way widths, design and character of all public streets shall be approved by the Commission. The internal roads of Map Section K shall be private.

(6) Buffer areas of not less than fifty feet in width shall be provided along Evansway Lane and Stony Point Road adjacent to Map Sections O and M. Such buffer areas shall be left in a natural state and shall include additional planting where necessary to provide an effective visual screen. There shall be no vehicular access through such buffer area adjacent to Map O.

(7) With the exception of Map Section K, all areas indicated on the 1988 Development Plan, 2018 Development Plan, or described in this Ordinance as buffer areas shall be left in their natural state, except for any clearing necessary for utility lines, drainage facilities, or means of access approved by the City. In the event that any clearing may be necessary, or in those areas where there is little or no existing vegetation, supplemental planting and/or fencing and berming

shall be provided in accordance with plans approved by the Commission. No signs shall be permitted in buffer areas, except as specifically authorized in 2A(7) of this Ordinance.

(8) Existing topography and trees shall be retained wherever practicable, and appropriate measures shall be taken to prevent soil erosion during and after construction. There shall be no clearing or grading until after plans are approved by the Commission.

(9) Final detailed plans, including site plans, typical floor plans, elevation drawings, landscaping plans and grading, drainage, and utility plans for each phase of the development shall be submitted to and approved by the Commission within 12 months of approval of the Preliminary Plan and prior to the issuance of building permits. The Commission shall, by formal resolution, approve such plans if it finds them to be consistent with the objectives of the preliminary plan and not in conflict with any of the conditions specified herein. Otherwise, the Commission shall not approve such plans. Building permits shall be requested within 18 months of the date of Commission approval of final plans. Plans submitted for building permit approval shall be substantially in conformance with the plans approved by the Commission.

§ 3. That, if no modifications are made to the development standards, as they pertain to Map [~~Sections A and D~~] Section A-1 of the [~~Southern~~] Northern Portion of the Plan, which [~~allow~~] allows for [~~additional signage~~] an accessory dwelling unit at the property known as 3417 Stony Point Road and identified as Tax Parcel No. C001-0757/056 in the 2021 records of the City Assessor, after the date on which this amendatory ordinance is adopted, the Director of Planning and Development Review may deem the preliminary plan amendment adopted by this amendatory ordinance to be the final plan for purposes of section 30-456.9 of the Code of the City of Richmond [~~(2015)~~] (2020), as amended. In the event that application for a [~~final plan~~] building permit is not made within 12 months from the effective date of this ordinance, the provisions of this amendatory

ordinance pertaining to amending the permitted use and development standards, as they pertain to Map Section [~~K~~] A-1 of the [~~Southern~~] Northern Portion of the Plan, to allow for [~~residential development~~] an accessory dwelling unit at the property known as 3417 Stony Point Road and identified as Tax Parcel No. C001-0757/056 in the 2021 records of the City Assessor shall be null and void and of no further effect and all other provisions of this amendatory ordinance shall remain in effect and shall govern the use and development of all portions of the property.

§ 4. This amendatory ordinance shall be in force upon adoption.

II. This amendatory ordinance shall be in force and effect upon adoption.

A TRUE COPY:

TESTE:

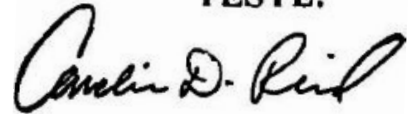
A handwritten signature in black ink that reads "Carlin D. Reed". The signature is written in a cursive style with a large initial "C".

City Clerk

2014 Development Summary (Northern Portions of the Tract)

Map Section	Approximate Area (acres)	Use	Maximum Development	Maximum Density	Minimum Gross Open Space	Minimum Livability Space
A-1	13.3	Single-Family Detached/ <u>Accessory Dwelling Unit</u>	6 <u>Single-Family Detached</u> units 1 <u>Accessory Dwelling Unit</u>	1.5 Units/Acre	n.a.	n.a.
D	31.4	Office/ Medical Use	261,000 s.f.*	0.19 FAR	85%	50%
E	44.7	Office/ Medical Use	474,000 s.f.*	0.25 FAR	80%	47%
F	19.9	Office/ Medical Use	234,000 s.f.*	0.27 FAR	85%	45%
K	61.7	Retail, Movie Theater, and Restaurants	750,000 s.f. gross leasable area	0.29 FAR	n.a.	n.a.
		Hotel	300 rooms	n.a.	n.a.	n.a.
		Parking serving other uses in Map Section K	n.a.	n.a.	n.a.	n.a.
L	101.06	Office Use	260,000 s.f.**	0.23 FAR	n.a.	n.a.
		Retail and Restaurants	20,000 s.f. gross leasable area**	0.29 FAR	n.a.	n.a.
		Residential	628 units**	10.2 Units/Acre	n.a.	n.a.
M	31.284	Single-Family Detached	15 units	n.a	n.a	n.a
n.a.	35.6	Right-of-Way for Chippenham Parkway	n.a.	n.a.	n.a.	n.a.
n.a.	5.6	Right of Way for Stony Point Parkway	n.a.	n.a.	n.a.	n.a.

* Not to exceed a total of 835,000 square feet of office and/or medical use in Sections D, E, and F.

** Maximum Development within Map Section L shall be subject to the additional restrictions applicable to various portions of Map Section L as set forth in the text of this Ordinance. Northern Map Section L is permitted for use, subject to the terms and conditions set forth in this Ordinance, as either (i) multi-family residential use or (ii) office, restaurant, and retail uses. If Northern Map Section L is used for multi-family residential use, the maximum development of office use within Map Section L shall be limited to “Middle” L, subject to the terms and conditions set forth in this Ordinance. Residential units shall be permitted within “Southern” L, up to 346 units, and “Northern” L up to 282 units, subject to the terms and conditions set forth in this Ordinance; provided, however, the density on “Southern” L shall not exceed 9.5 units per acre.

Trip Generation Table

Use	Trip Generation (in trips per hour): AM Peak	Trip Generation (in trips per hour): PM Peak
Retail (including low turnover, sit-down restaurants)	0.69 per 1,000 s.f. of gross leasable area	3.10 per 1,000 s.f. of gross leasable area
Office	1.37 per 1,000 s.f.	1.29 per 1,000 s.f.
Hotel	0.68 per 1 room	0.67 per 1 room
Multi-family Residential	0.51 per 1 unit	0.59 per 1 unit
Senior Residential (detached)	0.21 per 1 unit	0.23 per 1 unit
Senior Residential (attached)	0.07 per 1 unit	0.10 per 1 unit
Single-family Residential (detached)	0.75 per 1 unit	1.01 per 1 unit
Single-family Residential (attached, including condominium and townhouses)	0.44 per 1 unit	0.54 per 1 unit

City of Richmond

900 East Broad Street
2nd Floor of City Hall
Richmond, VA 23219
www.rva.gov

Item Request File Number: PRE.2021.661

O & R Request

DATE: May 28, 2021 **EDITION:** 1

TO: The Honorable Members of City Council

THROUGH: The Honorable Levar M. Stoney, Mayor (Patron: Mayor, by Request)
(This in no way reflects a recommendation on behalf of the Mayor)



THROUGH: J.E. Lincoln Saunders, Acting Chief Administrative Officer *JELS*

THROUGH: Sharon L. Ebert, Deputy Chief Administrative Officer for Economic
Development and Planning



for Sharon L. Ebert

FROM: Kevin J. Vonck, Acting Director, Dept. of Planning and Development Review *Kevin J. Vonck*

RE: To amend and reordain Ord. No. 75-309-302, adopted Dec. 15, 1975, as most recently amended by Ord. No. 2018-304, adopted Dec. 10, 2018, pertaining to the "Stony Point Community Unit Plan," for the purpose of amending the development standards, as they pertain to Map Section A-1 of the Northern Portion of the Plan, to allow for an accessory dwelling unit at 3417 Stony Point Road.

ORD. OR RES. No. ____

PURPOSE: To amend and reordain Ord. No. 75-309-302, adopted Dec. 15, 1975, as most recently amended by Ord. No. 2018-304, adopted Dec. 10, 2018, pertaining to the "Stony Point Community Unit Plan," for the purpose of amending the development standards, as they pertain to Map Section A-1 of the Northern Portion of the Plan, to allow for an accessory dwelling unit at 3417 Stony Point Road.

REASON: The applicant is requesting an amendment the Stony Point Community Unit Plan, Map Section A-1 of the Northern Portion of the Plan. Map Section A-1 does not currently allow accessory dwelling units and restricts the height of accessory buildings to twenty feet (20'). The applicant is seeking an amendment to allow for the construction of an accessory dwelling unit at 3417 Stony Point Road, with a building height of up to twenty-five feet (25').

RECOMMENDATION: In accordance with the requirements of the City Charter and the Zoning Ordinance, the City Planning Commission will review this request and make a recommendation to City Council at its July 19, 2021 meeting.

BACKGROUND: The subject property is approximately 20,400 square feet (0.47 acres) and is located within the Chestnut Oaks neighborhood of the Huguenot Planning District. It one of four single-family properties that comprise Map Section A-1 of the Stony Point Community Unit Plan (Northern Portion) and as such, is governed by the Stony Point CUP Ordinance (Ord. No. 2018-304). The property is improved with a single-family detached dwelling that was recently constructed.

The Richmond 300 Master Plan recommends a future land use of “Residential” for the property. The primary uses envisioned for Residential are single-family houses, accessory dwelling units, and open space. Secondary uses are duplexes and small multi-family buildings (typically 3-10 units), institutional, and cultural. The development style is medium-sized and large-sized lots in a largely auto-dependent environment. Homes are setback from the street. Future developments continue and/or introduce a gridded street pattern to increase connectivity. Future single-family housing, accessory dwelling units, duplexes and small multi-family residential buildings are built to a scale and design that is consistent with existing buildings. Buildings are generally one to three stories, with lot sizes ranging up to 5,000 square feet to 20,000 square feet. Residential density is typically two to ten housing units per acre.

Properties to the east, north and south of the subject property are also located within the Stony Point Community Unit Plan. Properties to the west are located in the R-2 Single-Family Residential Zoning District. Single-family residential uses are located to the east, west and south, and the Sabot School is located to the north.

FISCAL IMPACT / COST: The Department of Planning and Development Review does not anticipate any impact to the City’s budget for this or future fiscal years.

FISCAL IMPLICATIONS: Staff time for processing the request; preparation of draft ordinance; and publishing, mailing and posting of public notices.

BUDGET AMENDMENT NECESSARY: No

REVENUE TO CITY: \$1,500 application fee

DESIRED EFFECTIVE DATE: Upon Adoption

REQUESTED INTRODUCTION DATE: June 28, 2021

CITY COUNCIL PUBLIC HEARING DATE: July 26, 2021

REQUESTED AGENDA: Consent

RECOMMENDED COUNCIL COMMITTEE: None

CONSIDERATION BY OTHER GOVERNMENTAL ENTITIES: City Planning Commission
July 19, 2021

AFFECTED AGENCIES: Office of Chief Administrative Officer
Law Department (for review of draft ordinance)

RELATIONSHIP TO EXISTING ORD. OR RES.: Amend Ord. No. 2018-304

REQUIRED CHANGES TO WORK PROGRAM(S): None

ATTACHMENTS: Draft Ordinance, Application Form, Applicant's Report, Plans, Survey, Map

STAFF: Richard Saunders, Senior Planner, Land Use Administration (Room 511) 646-5648

2014 Development Summary (Northern Portions of the Tract)

Map Section	Approximate Area (acres)	Use	Maximum Development	Maximum Density	Minimum Gross Open Space	Minimum Livability Space
A-1	13.3	Single-Family Detached	[3] 6 units	1.5 Units/Acre	n.a.	n.a.
D	31.4	Office/ Medical Use	261,000 s.f.*	0.19 FAR	85%	50%
E	44.7	Office/ Medical Use	474,000 s.f.*	0.25 FAR	80%	47%
F	19.9	Office/ Medical Use	234,000 s.f.*	0.27 FAR	85%	45%
K	61.7	Retail, Movie Theater, and Restaurants	750,000 s.f. gross leasable area	0.29 FAR	n.a.	n.a.
		Hotel	300 rooms	n.a.	n.a.	n.a.
		Parking serving other uses in Map Section K	n.a.	n.a.	n.a.	n.a.
L	101.06	Office Use	260,000 s.f.**	0.23 FAR	n.a.	n.a.
		Retail and Restaurants	20,000 s.f. gross leasable area**	0.29 FAR	n.a.	n.a.
		Residential	628 units**	10.2 Units/Acre	n.a.	n.a.
M	31.284	Single-Family Detached	15 units	n.a	n.a	n.a
n.a.	35.6	Right-of-Way for Chippenham Parkway	n.a.	n.a.	n.a.	n.a.
n.a.	5.6	Right of Way for Stony Point Parkway	n.a.	n.a.	n.a.	n.a.

* Not to exceed a total of 835,000 square feet of office and/or medical use in Sections D, E, and F.

** Maximum Development within Map Section L shall be subject to the additional restrictions applicable to various portions of Map Section L as set forth in the text of this Ordinance. Northern

Map Section L is permitted for use, subject to the terms and conditions set forth in this Ordinance, as either (i) multi-family residential use or (ii) office, restaurant, and retail uses. If Northern Map Section L is used for multi-family residential use, the maximum development of office use within Map Section L shall be limited to “Middle” L, subject to the terms and conditions set forth in this Ordinance. Residential units shall be permitted within “Southern” L, up to 346 units, and “Northern” L up to 282 units, subject to the terms and conditions set forth in this Ordinance; provided, however, the density on “Southern” L shall not exceed 9.5 units per acre.

Trip Generation Table

Use	Trip Generation (in trips per hour): AM Peak	Trip Generation (in trips per hour): PM Peak
Retail (including low turnover, sit-down restaurants)	0.69 per 1,000 s.f. of gross leasable area	3.10 per 1,000 s.f. of gross leasable area
Office	1.37 per 1,000 s.f.	1.29 per 1,000 s.f.
Hotel	0.68 per 1 room	0.67 per 1 room
Multi-family Residential	0.51 per 1 unit	0.59 per 1 unit
Senior Residential (detached)	0.21 per 1 unit	0.23 per 1 unit
Senior Residential (attached)	0.07 per 1 unit	0.10 per 1 unit
Single-family Residential (detached)	0.75 per 1 unit	1.01 per 1 unit
Single-family Residential (attached, including condominium and townhouses)	0.44 per 1 unit	0.54 per 1 unit



Application for: **COMMUNITY UNIT PLAN**

Department of Planning and Development Review
Land Use Administration Division
900 E. Broad Street, Room 511
Richmond, Virginia 23219
(804) 646-6304
<http://www.richmondgov.com/>

Application is hereby submitted for: (check one)

- preliminary plan
- preliminary plan admendment
- Final Plan
- Final Plan Admenment

Project Name/Location

Property Address: 3417 Stony Point Road Date: 3/12/2021
Tax Map #: C0010757056 Fee: 1500
Total area of affected site in acres: 0.4691

(See page 7 for fee schedule, please make check payable to the "City of Richmond")

Zoning

Current Zoning: CUP (Ord. 2015-023-40)
Existing Use: Single-family detached dwelling

Proposed Use

(Please include a detailed description of the proposed use in the required applicant's report)

One dwelling unit in a building accessory to the existing single-family dwelling.
Existing Use: Single-family detached dwelling

Is this property subject to any previous land use cases?

Yes No If Yes, please list the Ordinance Number: Ord. 2015-023-40

Applicant/Contact Person: Mark J. Kronenthal / Mark Baker

Company: Roth Jackson Gibbons Conclin PLC
Mailing Address: 1519 Summit Avenue, Suite 102
City: Richmond State: VA Zip Code: 23230
Telephone: (804) 822-5428 Fax: ()
Email: mkronenthal;@rothjackson.com, markbaker@bakerdevelopmentresources.com

Property Owner: SAUNDERS BARRY E JR AND EMILIE B

If Business Entity, name and title of authorized signee: _____

(The person or persons executing or attesting the execution of this Application on behalf of the Company certifies that he or she has or have been duly authorized and empowered to so execute or attest.)

Mailing Address: 8501 ACADEMY RD
City: Henrico State: VA Zip Code: 23229
Telephone: (804) 363-4238 Fax: ()
Email: barrysaundersva@gmail.com

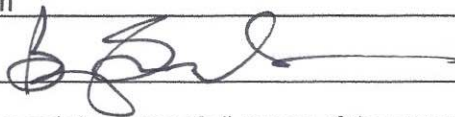
Property Owner Signature: 

The names, addresses, telephone numbers and signatures of all owners of the property are required. Please attach additional sheets as needed. If a legal representative signs for a property owner, please attach an executed power of attorney. **Faxed or photocopied signatures will not be accepted.**

NOTE: Please attach the required plans, checklist, and a check for the application fee (see Filing Procedures for community unit plans)

March 12, 2021

BY ELECTRONIC DELIVERY

Mr. Matthew Ebinger
City of Richmond DPDR
Land Use Administration Division, Room 511
City Hall, 900 East Broad Street
Richmond, Virginia 23219

Mark J. Kronenthal
Richmond Office
(804) 441-8603 (direct)
mkronenthal@rothjackson.com

Re: Community Unit Plan Preliminary Plan Amendment and Final Plan: 3417 Stony Point Road (C0010757056)

Dear Mr. Ebinger:

This letter shall serve as the applicant's report for the Community Unit Plan Preliminary Plan Amendment (the "CUP Amendment") and Final Plan for 3417 Stony Point Road (the "Property") in order to authorize the construction of an accessory dwelling unit. The CUP Amendment would modify the development standards applicable to Map Section A-1 of the Stony Point Community Unit Plan (Ordinance No. 2015-23-40; the "CUP"), adopted December 15, 1975 and most recently amended on January 26, 2015, for the purposes of permitting an accessory dwelling for the Property. The Final Plan would authorize the specific details related to the construction of the accessory dwelling unit on the Property.

The Property lies on the south side of Stony Point Road between Evansway Lane and Laurus Court and is referenced by the City Assessor as tax parcel C001-0757/056. The Property is 127 feet in width and includes 20,432 square feet of lot area. The Property is improved with a two-story single-family detached dwelling containing 3,162 square feet of floor area, which was built in 2020.

The Property and several other adjacent properties to the west south and east lie within the CUP, Map Section A-1. The CUP was last amended in 2015 in order to permit the subdivision of one of three original lots in Map Section A-1 into four lots, including the subject Property. This resulted in a total of six lots within Map section A-1. The feature requirements outlined in the CUP for these lots require that single-family detached dwellings "shall conform to the requirements of the R-1 Single-Family Residential District as set forth in Chapter 114 of the City Code, provided that maximum density, the general configuration of lots, and the 50-foot buffer..." shall be as contemplated by the plat attached to that request. Four of the lots are improved with single-family dwellings; the remaining two are vacant. Immediately to the west, lie properties that are zoned R-2 Single-Family Residential – a small ten lot subdivision that is surrounded by land within the CUP. To the south, beyond the CUP lies the Fernleigh

RICHMOND

1519 Summit Avenue, Suite 102, Richmond, VA 23230
P: 804-441-8440 F: 804-441-8438

TYSONS CORNER

8200 Greensboro Drive, Suite 820, McLean, VA 22102
P: 703-485-3535 F: 703-485-3525

neighborhood which is zoned R-2 and consists of single-family dwellings. Across Stony Point Road to the north are properties that are zoned R-2 and are utilized as a private school and public park land. Further to the northeast lies a development including multifamily condominium dwelling units within the southern tract of the CUP.

The recently approved Richmond 300 plan (the “Master Plan”) recommends “Residential” for the Property and other properties located within Map Section A-1. This designation envisions single-family dwellings along with accessory dwelling units as primary uses. The Master Plan further recommends that accessory dwelling units “are built to a scale and design that is consistent with existing buildings.” In addition to the site-specific recommendation for the Property there is additional text guidance in support of the request, including Goal 14: Housing, which includes in Objective 14.9 the recommendation to “Amend the Zoning Ordinance to allow accessory dwelling units in all residential zones to allow for in-law apartments.”

The CUP Amendment would permit the construction of an accessory dwelling unit on the Property. This would include the amendment of the CUP text to permit one dwelling unit located in an accessory building as an accessory use to a single-family dwelling. The height of the accessory building would be limited to two stories. In all other regards the Property would continue to be subject to the requirements of the R-1 Single-Family Residential District as outlined for Map Section A-1 in the CUP.

The Final Plan would authorize the specific details related to the construction of the accessory dwelling unit on the Property. The accessory dwelling unit would be located on the second floor of a two-story accessory garage building. The accessory building would be 36 feet by 28 feet in dimension with a height of just under 25 feet. The building was designed with the second-floor area built into the roof line and utilizing shed dormers in order to minimize the overall massing of the building. This design also provides for compatibility with the primary single-family detached dwelling which shares a similar roof form, architectural details and siding materials. The building would be clad in lap siding with a masonry foundation clad in brick. The accessory dwelling unit would consist of an open living/flex space with a small kitchen, a full bath, and an office/bedroom space.

At over 20,000 square feet in area, the Property is large by City standards. The accessory building would be sited in manner that would minimize its visibility. The building would be located behind the main building and centrally on the lot with side yards of 22.1 and 25 feet which are substantially larger than the required 10 feet. The accessory building would be setback over 50 feet from the rear property line. The CUP requires a 50-foot buffer in this area which includes extensive tree cover and would remain undisturbed. Access to the accessory building would be provided from a drive from Stony Point Road.

The following are factors included in Section 30-456.4 of the Zoning Ordinance relative to the approval of Community Unit Plan preliminary plans. The proposed Amendment will:

- ***Adequately safeguard the health, safety and welfare of the occupants of the adjoining and surrounding property;***



RICHMOND

1519 Summit Avenue, Suite 102, Richmond, VA 23230

P: 804-441-8440 F: 804-441-8438

TYSONS CORNER

8200 Greensboro Drive, Suite 820, McLean, VA 22102

P: 703-485-3535 F: 703-485-3525

- The CUP Amendment will not impact the safety, health, morals and general welfare of the nearby neighborhoods. The request is consistent with the Master Plan recommendation which is intended to safeguard these items.
- ***Not unreasonably impair an adequate supply of light and air to adjacent property;***
 - The light and air available to the subject and adjacent properties will not be affected. The proposed accessory dwelling unit would be located within an accessory structure that, but for the dwelling, would be permitted by right substantially as proposed. Side yard setbacks exceed the district minimum by a factor of two and a 50-foot buffer, unique to single-family residential development, is provided at the rear of the Property. As a result, this request will not interfere with the provision of adequate light and air to the adjacent buildings.
- ***Not unreasonably increase congestion in streets;***
 - The CUP Amendment will not result in significant traffic impacts to nearby residential neighborhoods. The negligible traffic generation of one accessory dwelling unit will create no congestion on streets, roads, alleys or any other public right of way.
- ***Not unreasonably increase public danger from fire or otherwise unreasonably affect public safety;***
 - The Property will be developed in a manner consistent with the requirements of the building code and in accordance with the requirements of Fire and Emergency Services. The City's codes applicable to this development are designed to eliminate such hazards.
- ***Not diminish or impair the established values of property in surrounding areas;***
 - The CUP Amendment would include high-quality construction that is designed to complement the main dwelling on the Property. This investment will increase property value and will not diminish or impair the established values of properties in surrounding areas.

In summary, we are enthusiastically seeking approval of the CUP Amendment and Final Plan. Approval of this request would permit the construction of the proposed accessory building as a high-quality improvement which would address the owners' desire to improve the functionality and livability of the Property. The building has been thoughtfully designed in order to be in keeping with the architectural character of the existing dwelling on the property. The scale and location of the building, along with its relationship to the existing dwelling on the Property, is consistent with the development pattern that is typical in single-family residential neighborhoods. The request offers compatibility with the Master Plan's property-specific land use guidance as well as its broader goals for encouraging more diverse housing types throughout the city.

Thank you for your time and consideration of this request, please let me know if you have any questions.

Sincerely,



Mark J. Kronenthal

Enclosures

cc:

The Honorable Kristen Larson, Councilperson



RICHMOND

1519 Summit Avenue, Suite 102, Richmond, VA 23230

P: 804-441-8440 F: 804-441-8438

TYSONS CORNER

8200 Greensboro Drive, Suite 820, McLean, VA 22102

P: 703-485-3535 F: 703-485-3525

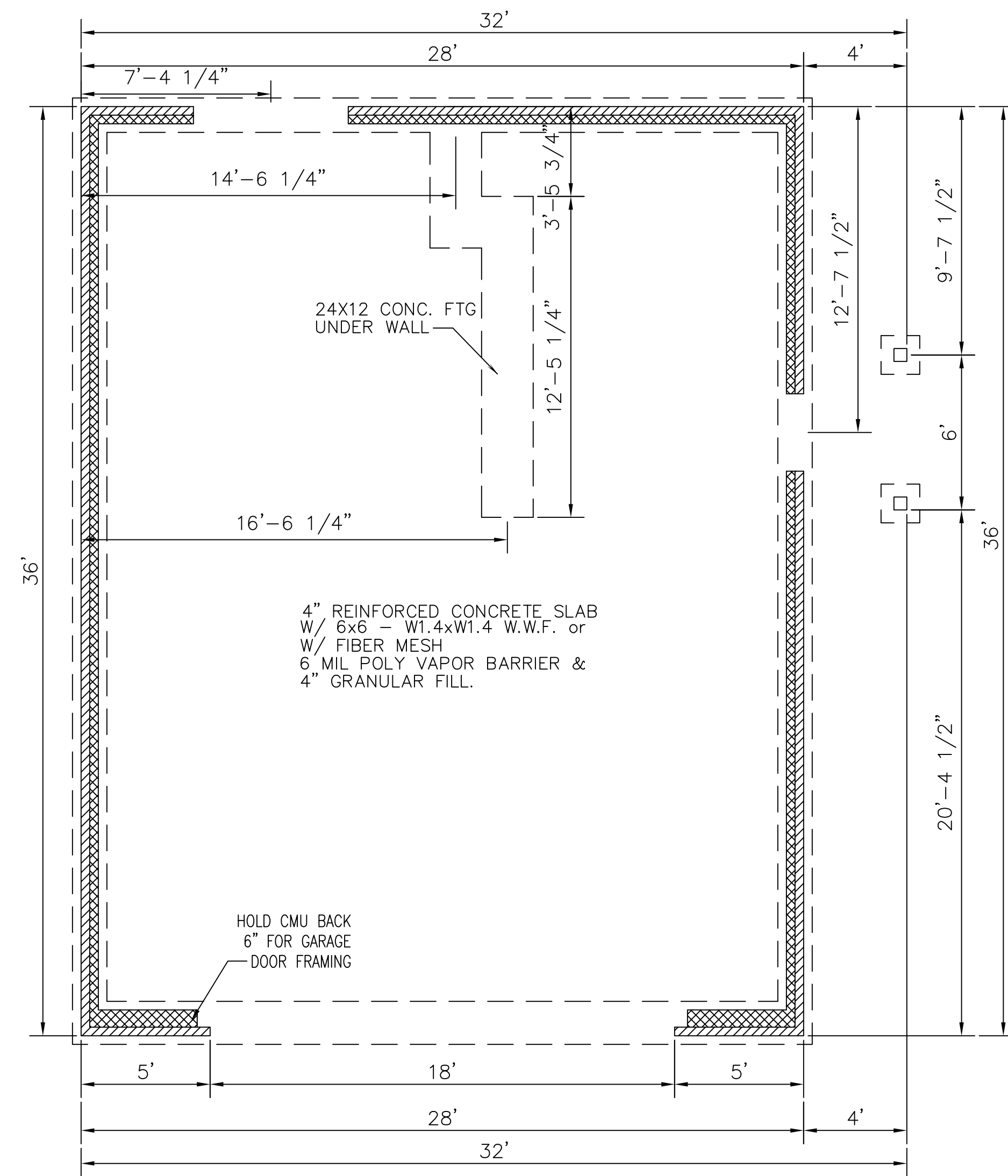

FOUNDATION PLAN

SCALE: 1/4"=1'-0"

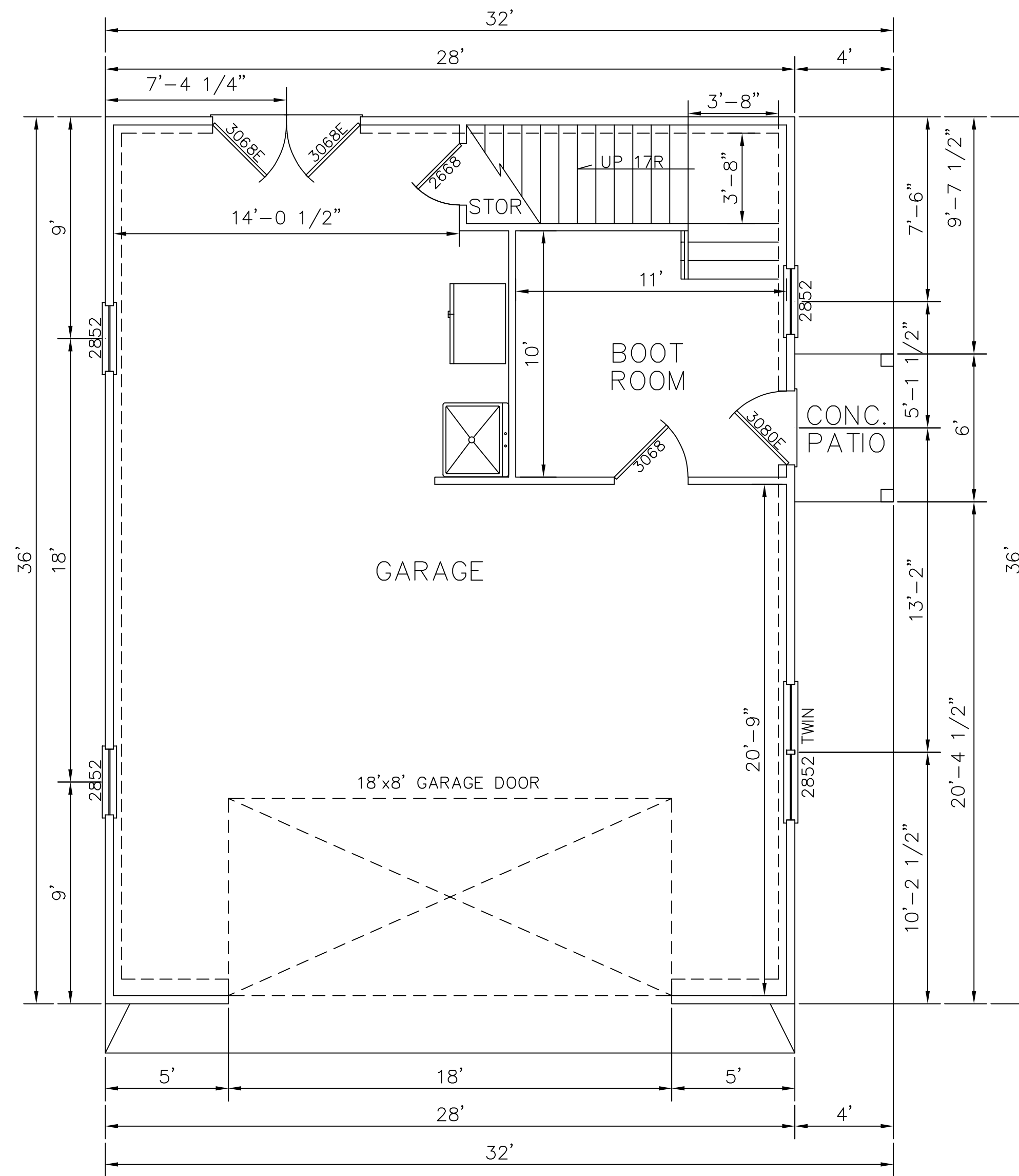

FIRST FLOOR PLAN

SCALE: 1/4"=1'-0"

JEROME JACKSON
 P.O. BOX 161, SANDY HOOK, VA 23153
 PH (804) 350-1534

SANDERS GARAGE
 JOB-1908

RIDGE HOMES, LLC
 7405 WILLOW CROSSING TERRACE
 RICHMOND, VA 23228
 (804) 641-2369

DRAWN BY: JMJ
 DATE: 2/11/21
 SCALE: 1/4"=1'-0"
 SHEET 1

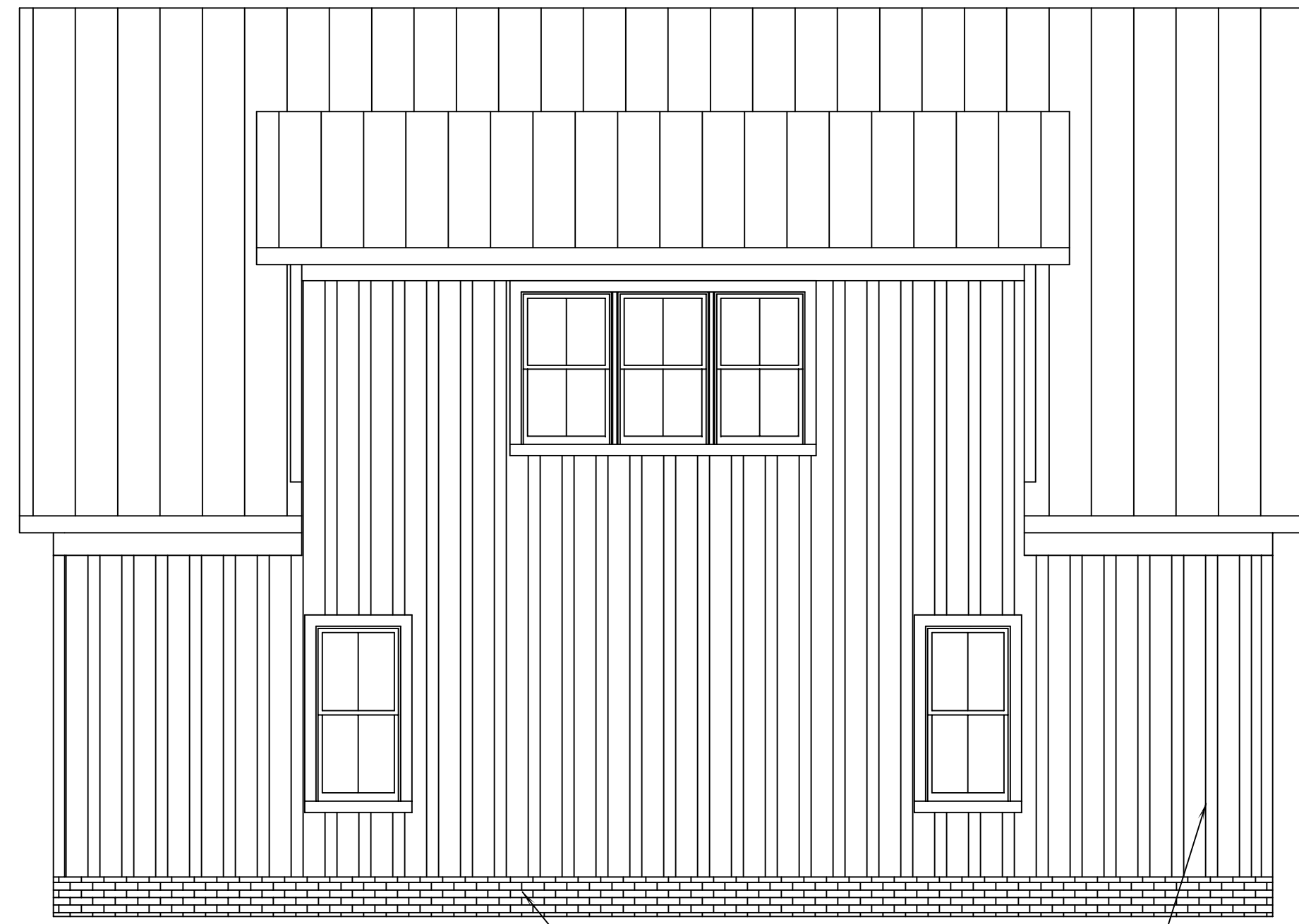

BRICK FOUNDATION VINYL SIDING

REAR ELEVATION

SCALE: 1/4"=1'-0"



BRICK FOUNDATION VINYL SIDING

FRONT ELEVATION

SCALE: 1/4"=1'-0"

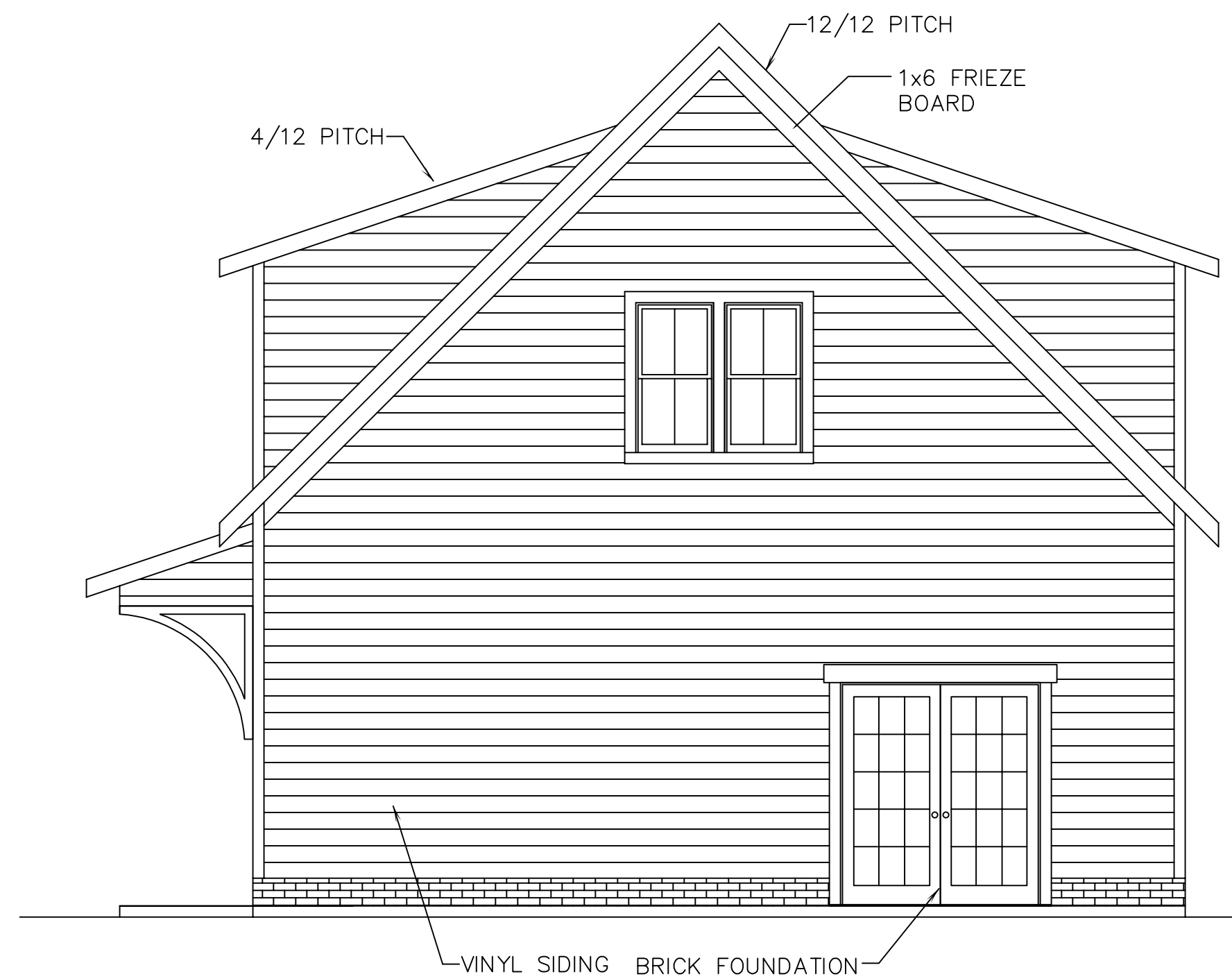

VINYL SIDING BRICK FOUNDATION

RIGHT ELEVATION

SCALE: 1/4"=1'-0"

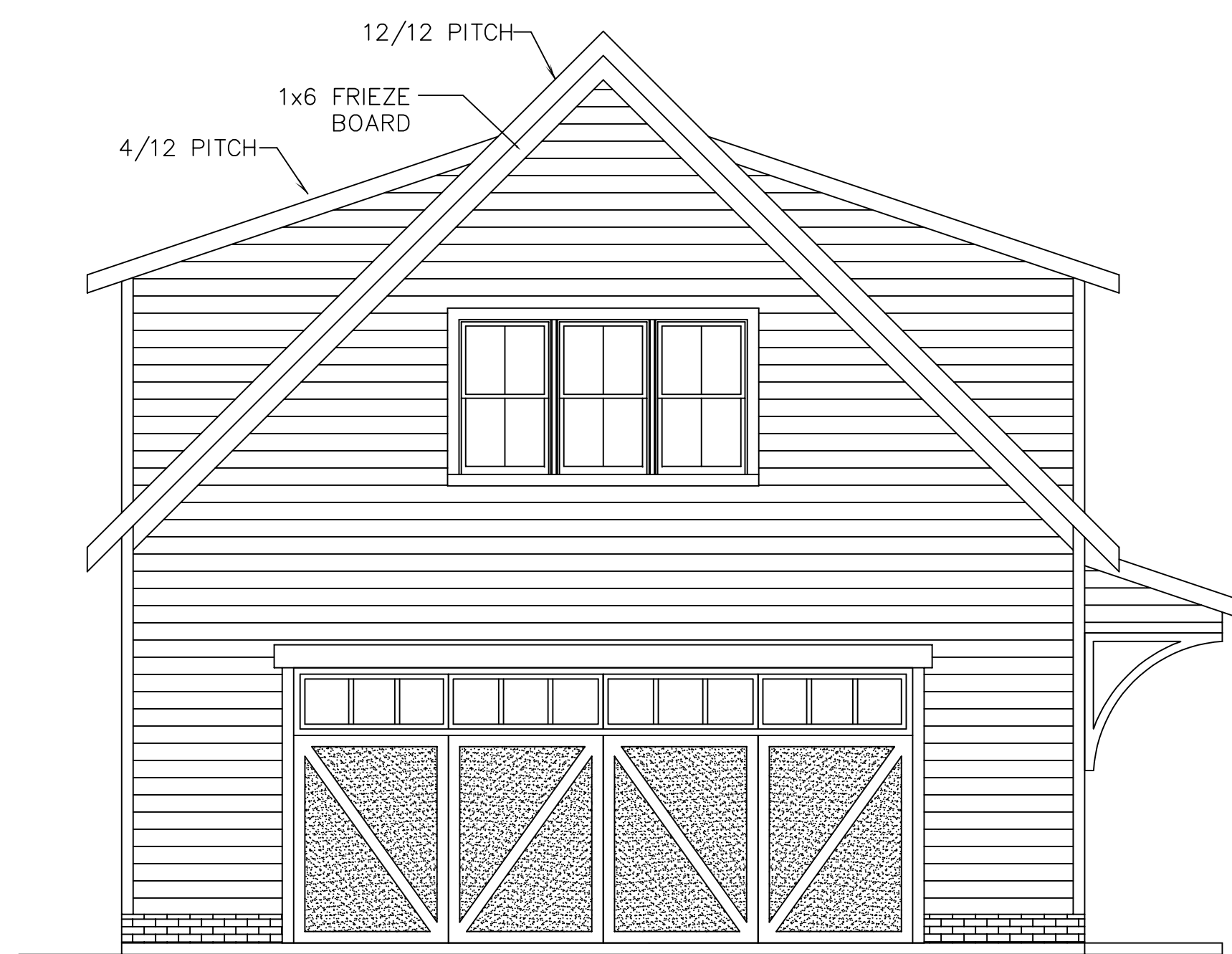

LEFT ELEVATION

SCALE: 1/4"=1'-0"

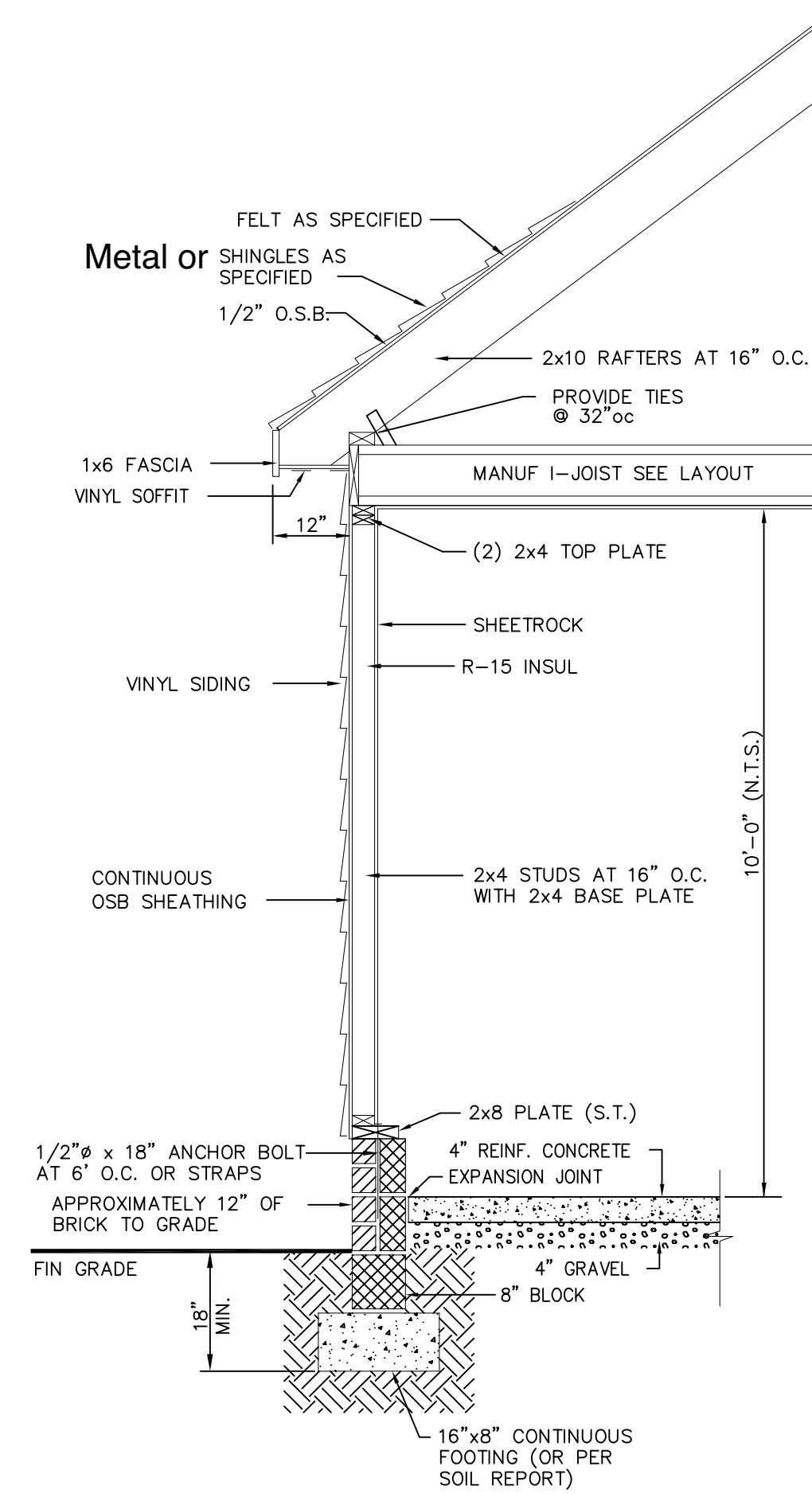

FELT AS SPECIFIED
 SHINGLES AS SPECIFIED
 1/2" O.S.B.
 2x10 RAFTERS AT 16" O.C.
 PROVIDE TIES @ 32" OC
 1x6 FASCIA
 VINYL SOFFIT
 12"
 MANUF I-JOIST SEE LAYOUT
 (2) 2x4 TOP PLATE
 SHEETROCK
 R-15 INSUL
 VINYL SIDING
 CONTINUOUS OSB SHEATHING
 2x4 STUDS AT 16" O.C. WITH 2x4 BASE PLATE
 10'-0" (N.I.S.)
 2x8 PLATE (S.T.)
 4" REINF. CONCRETE EXPANSION JOINT
 1/2" x 18" ANCHOR BOLT AT 6" O.C. OR STRAPS APPROXIMATELY 12" OF BRICK TO GRADE
 FIN GRADE
 18" MIN.
 4" GRAVEL
 8" BLOCK
 16"x8" CONTINUOUS FOOTING (OR PER SOIL REPORT)

TYPICAL WALL SECTION

SCALE: NTS

JEROME JACKSON
 P.O. BOX 161, SANDY HOOK, VA 23153
 PH (804) 350-1534

SALINDERS GARAGE
 JOB-1908

RIDGE HOMES, LLC
 7405 WILLOW CROSSING TERRACE
 RICHMOND, VA 23228
 (804) 641-2369

DRAWN BY: JMJ
 DATE: 2/11/21
 SCALE: 1/4"=1'-0"
 SHEET 3

NOTE:

THIS PLOT PLAN DOES NOT REPRESENT AN ACTUAL FIELD SURVEY.

THIS PROPERTY IS LOCATED IN ZONE "X" AS SHOWN ON THE FLOOD INSURANCE RATE MAP NUMBER 5101290012D; EFFECTIVE DATE: APRIL 2, 2009.

SUBDIVISION PLAT BY E.D. LEWIS & ASSOCIATES, P.C. DATED: JUNE 22, 2017

AREA OF DISTURBANCE = 15,290 SQ.FT.

ZONED: R-2 & CUP

SETBACKS

FRONT = 60'
SIDES = 10'
REAR = 50'

LOT 2, CHESTNUT OAKS
BLOCK A
STEVEN H. JONES
& HOLLY H. JONES
INST. NO.: 160018891
D.B. 140, PG. 1608

STEVEN H. JONES
& HOLLY H. JONES
INST. NO.: 160018891

MAD 83
VIRGINIA SOUTH
CHESTNUT OAKS, SECTION 2

STONEY POINT GREEN
LOT 2

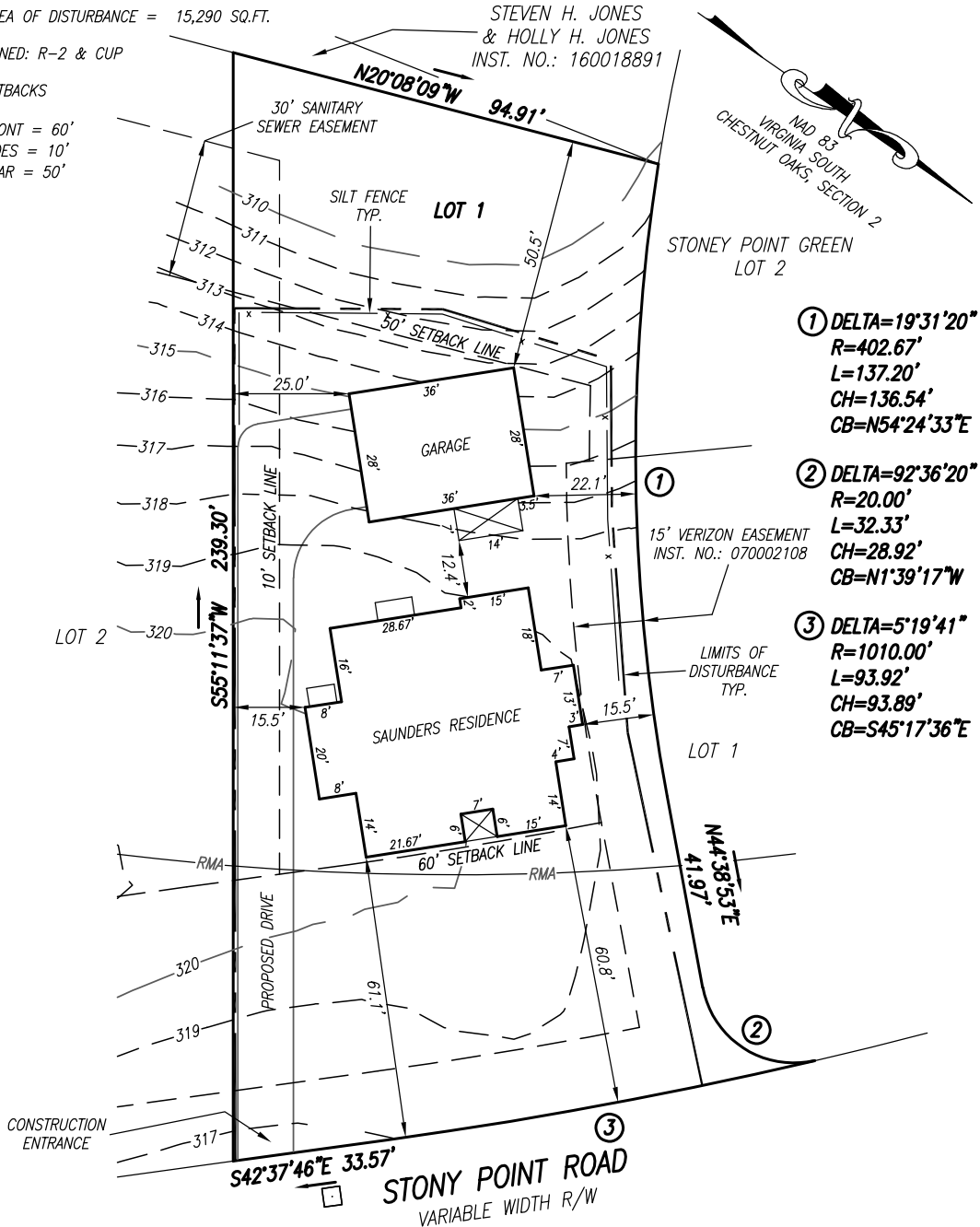

PLOT PLAN OF LOT 1, BLOCK A, SECTION 2, CHESTNUT OAKS, A RESUBDIVISION OF LOT 3, BLOCK A, CHESTNUT OAKS AND A PORTION OF RESERVED STONEY POINT GREEN, STONEY POINT CUP MAP SECTION A-1, CITY OF RICHMOND, VIRGINIA

DATE: APRIL 16, 2018
REVISED: MARCH 4, 2020

SCALE: 1" = 30'



E.D. Consulting Engineers · Land Surveyors & Planners
LEWIS & ASSOCIATES P.C.
2116 Spencer Road · Richmond, VA 23230

15302PP