



# City of Richmond Department of Planning & Development Review

## Location, Character, and Extent

**LOCATION:** 6300 Hull Street

**COUNCIL DISTRICT:** 9

**PROPOSAL:** Final location, character, and extent review of a new monument sign at River City Middle school.

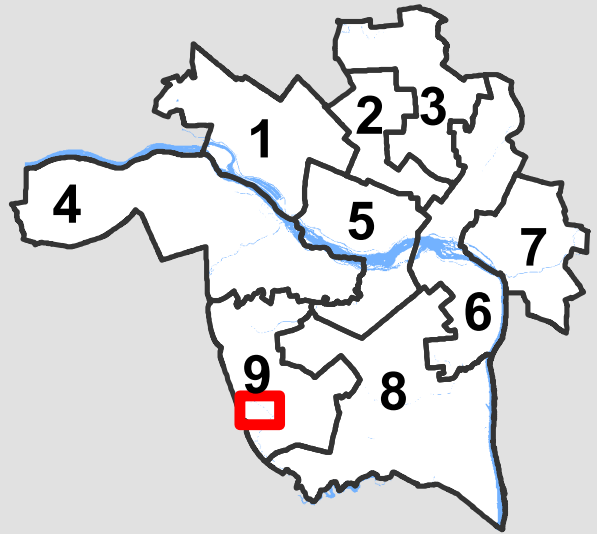

*For questions, please contact Alex Dandridge at 646-6569 or alex.dandridge@richmondgov.com*

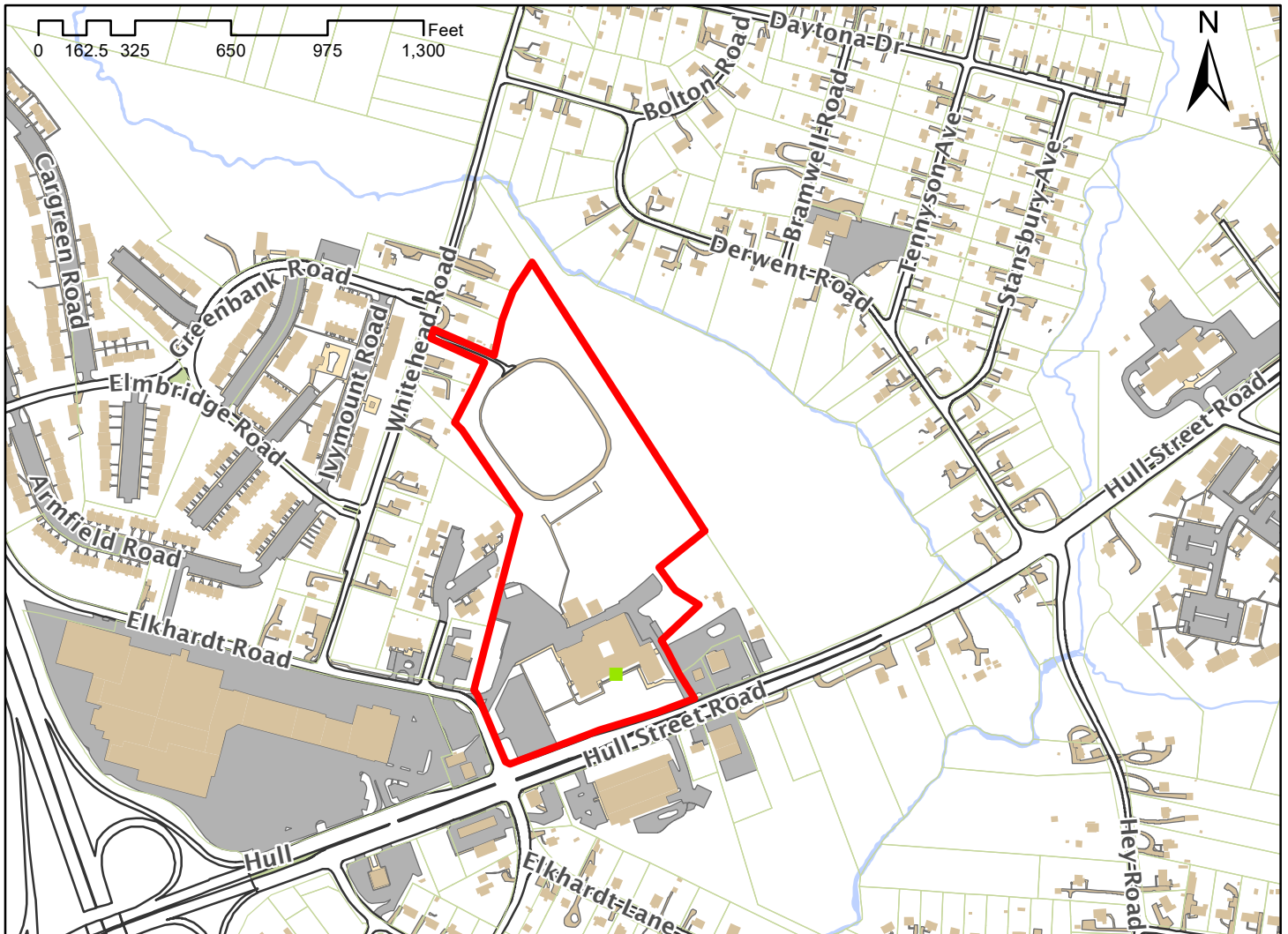



## Application for Urban Design Committee Review

Department of Planning and Development Review

Planning & Preservation Division

900 E. Broad Street, Room 510

Richmond, Virginia 23219 | (804) 646-6335

<https://www.rva.gov/planning-development-review/urban-design-committee>



### Application Type (select one)

Location, Character, & Extent

Section 17.05

Other:

Encroachment

Design Overlay District

### Review Type (select one)

Conceptual

Final

### Project Information

Submission Date: 2-11-21

Project Name: River City Middle School

Project Address: 6300 Hull Street Road, Richmond, VA 23224

Brief Project Description (this is not a replacement for the required detailed narrative):

Construction of a standalone, brick and precast concrete monumental sign with an integral LED display board at the new River City School.

### Applicant Information (a City representative must be the applicant, with an exception for encroachments)

Name: Jason Kamras

Email: jkamras@rvaschools.net

City Agency: Richmond Public Schools

Phone: 804-780-7710

Main Contact (if different from Applicant): Michael McIntyre

Company: AECOM

Phone: 781-572-6014

Email: michael.mcintyre@aecom.com

### Submittal Deadlines

All applications and support materials must be filed no later than 21 days prior to the scheduled meeting of the Urban Design Committee (UDC). Please see the schedule on page 3 as actual deadlines are adjusted due to City holidays. **Late or incomplete submissions will be deferred to the next meeting.**

### Filing

Applications can be mailed or delivered to the attention of "Urban Design Committee" at the address listed at the top of this page. **It is important that the applicant discuss the proposal with appropriate City agencies, Zoning Administration staff, and area civic associations and residents prior to filing the application with the UDC.**

### Submittal Deadlines

The UDC is an 11 member committee created by City Council in 1968 whose purpose is to advise the City Planning Commission (CPC) on the design of projects on City property or right-of-way. The UDC provides advice of an aesthetic nature in connection with the performance of the duties of the Commission under Sections 17.05, 17.06, and 17.07 of the City Charter. The UDC also advises the Department of Public Works in regards to private encroachments in the public right-of-way.



## Application for Urban Design Committee Review

Department of Planning and Development Review

Planning & Preservation Division

900 E. Broad Street, Room 510

Richmond, Virginia 23219 | (804) 646-6335

<https://www.rva.gov/planning-development-review/urban-design-committee>



### Submission Requirements

- An electronic copy (PDF preferred) of all application materials, which can be emailed, or delivered by FTP or USB.
- Three (3) copies of the application cover sheet and all support materials (see below).
- Plan sheets should be 11" x 17", folded to 8 1/2" x 11". If it is not possible to scale plans to these dimensions, please provide one set of larger, scaled plans.
- All applications must include the attached cover sheet and the following support materials, as applicable to the project, based on Review Type:

#### **Conceptual Review:**

- A detailed project narrative which includes the following: purpose of the project, project background, project budget and funding sources, description of construction program and estimated construction start date (description should also provide information on the surrounding area to provide context).
- A site plan for the project indicating site characteristics which include: building footprints, parking areas, pedestrian routes, recreation areas, open areas, and areas of future expansion.
- A set of floor plans and elevations, as detailed as possible.
- A landscaping plan which shows the general location and character of plant materials and notes any existing tree to be removed.

#### **Final Review:**

- A detailed project narrative which includes the following: purpose of the project, project background, project budget and funding sources, description of construction program, and estimated construction start date (description should also provide information on the surrounding area to provide context).
- A site plan for the project indicating site characteristics which include: building footprints, parking areas, pedestrian routes, recreation areas, open areas, and areas of future expansion.
- A set of floor plans and elevations, as detailed as possible.
- A landscaping plan that includes a complete plant schedule, the precise location of all plant materials, and a landscape maintenance analysis. The plant schedule must show number, size and type of each planting proposed. If existing trees are to be removed, their size, type, and location must be noted on the landscape plan.
- The location of all lighting units should be noted on a site plan, including wall-mounted, site, and parking lot lighting. Other site details such as benches, trash containers, and special paving materials should also be located. Include specification sheets for each item.
- Samples of all proposed exterior building materials, including but not limited to brick, mortar, shingles, siding, glass, paint, and stain colors. When an actual sample cannot be provided, a product information sheet that shows the item or a photo of an existing item may be substituted.

### Review and Processing

- Once an application is received, it is reviewed by Staff, who compiles a report that is sent to the UDC.
- A copy of the report and the meeting agenda will be sent to the applicant prior to the meeting.
- At the UDC meeting, the applicant or a representative should be present or the application may be deferred to the next regularly scheduled meeting. It is also strongly suggested that a representative of the City Agency which will have final responsibility for the item be present at the meeting (if the applicant and the representative are not the same).
- Once the UDC recommends action on the application, it is automatically placed on the agenda for the next City Planning Commission (CPC) meeting. Exceptions to this are encroachment applications, recommendations for which are forwarded to the Department of Public Works.
- At the CPC meeting, the applicant or a representative should be present, or the application may be deferred to the next regularly scheduled meeting.



## Application for Urban Design Committee Review

Department of Planning and Development Review  
Planning & Preservation Division  
900 E. Broad Street, Room 510  
Richmond, Virginia 23219 | (804) 646-6335  
<https://www.rva.gov/planning-development-review/urban-design-committee>



Regular meetings are scheduled on the Thursday after the first Monday of each month at **10:00 a.m.** in the **5th floor conference room of City Hall, 900 E. Broad Street**. Special meetings are scheduled as needed.

### Meeting Schedule 2021

UDC Meetings	UDC Submission Deadlines	Anticipated Date of Planning Commission Following the UDC Meeting
December 10, 2020	November 12, 2020	December 21, 2020
January 7, 2021	December 17, 2020	January 19, 2021 <sup>1</sup>
February 4, 2021	January 14, 2021	February 16, 2021 <sup>2</sup>
March 4, 2021	February 11, 2021	March 15, 2021
April 8, 2021	March 11, 2021	April 19, 2021
May 6, 2021	April 15, 2021	May 17, 2021
June 10, 2021	May 13, 2021	June 21, 2021
July 8, 2021	June 17, 2021	July 19, 2021
August 5, 2021	July 15, 2021	August 16, 2021 <sup>3</sup>
September 9, 2021	August 12, 2021	September 20, 2021
October 7, 2021	September 16, 2021	October 18, 2021
November 4, 2021	October 14, 2021	November 15, 2021
December 9, 2021	November 10, 2021 <sup>4</sup>	December 20, 2021 <sup>5</sup>

<sup>1</sup> Monday January 18, 2021 is a City of Richmond Holiday

<sup>2</sup> Monday February 15, 2021 is a City of Richmond Holiday

<sup>3</sup> This meeting is subject to cancellation. If so, Planning Commission hearing would be Tuesday September 7, 2021.

<sup>4</sup> Thursday November 11, 2021 is a City of Richmond Holiday.

<sup>5</sup> This meeting of the Planning Commission is subject to cancellation.

The Richmond Urban Design Committee is an 11 member advisory committee created by City Council in 1968. Its purpose is to advise the City Planning Commission on the design of City projects. The Urban Design Committee reviews projects for appropriateness in "location, character, and extent" and for consistency with the City's Master Plan and forwards recommendations to the City Planning Commission. The Urban Design Committee also advises the Department of Public Works in regards to private encroachments in the public right-of-way.

For more information, please contact the Planning and Preservation Division staff at (804) 646-6335 or Alex Dandridge at (804) 646-6569 or at [alex.dandridge@richmondgov.com](mailto:alex.dandridge@richmondgov.com).

# RIVER CITY MIDDLE SCHOOL

## EXISTING MONUMENT SIGN

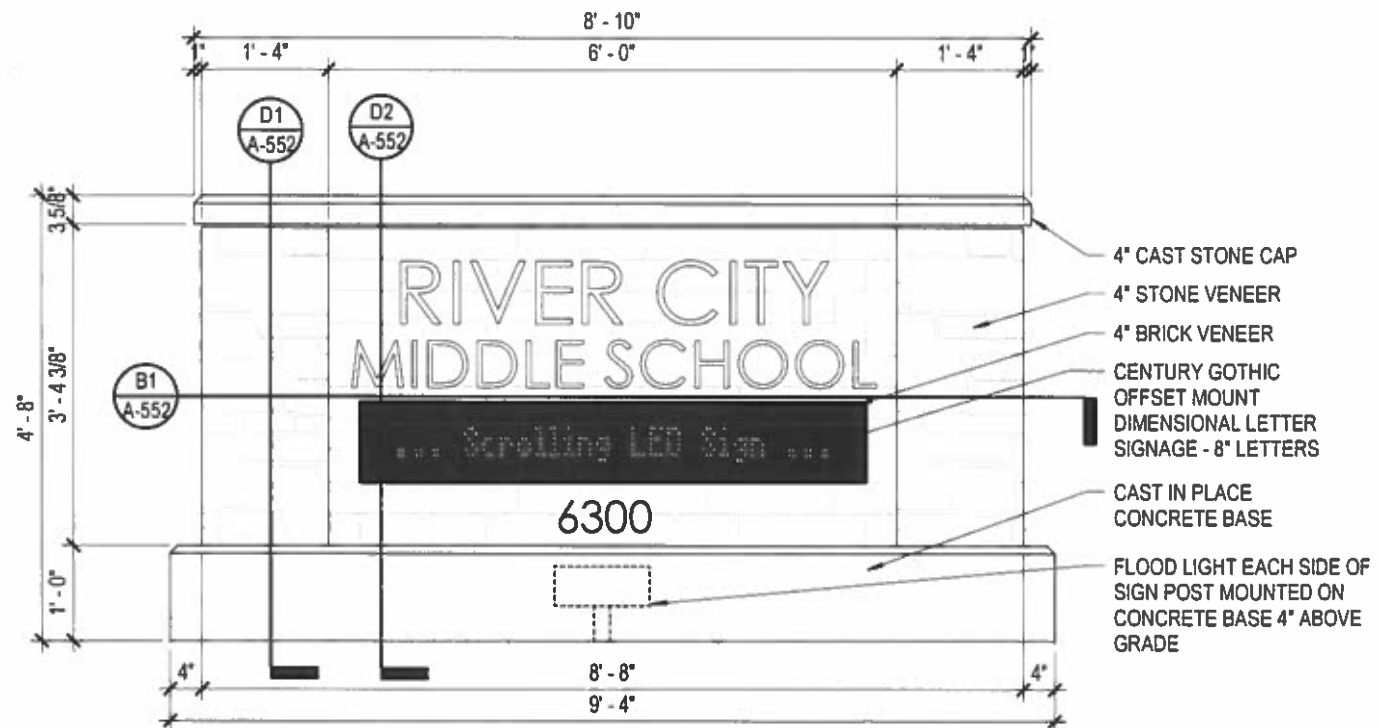
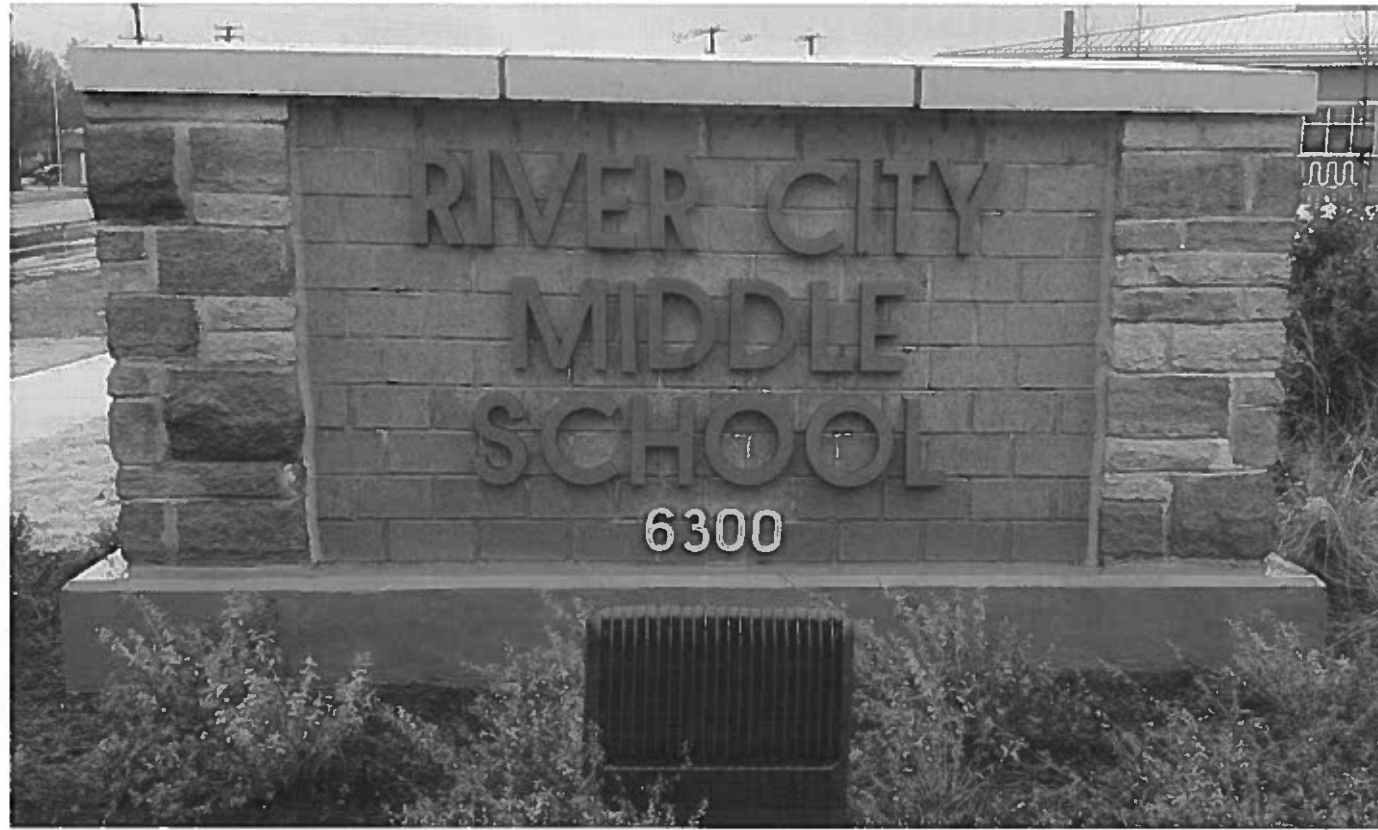



ADDITIONAL MONUMENT SIGN W/ DIGITAL DISPLAY

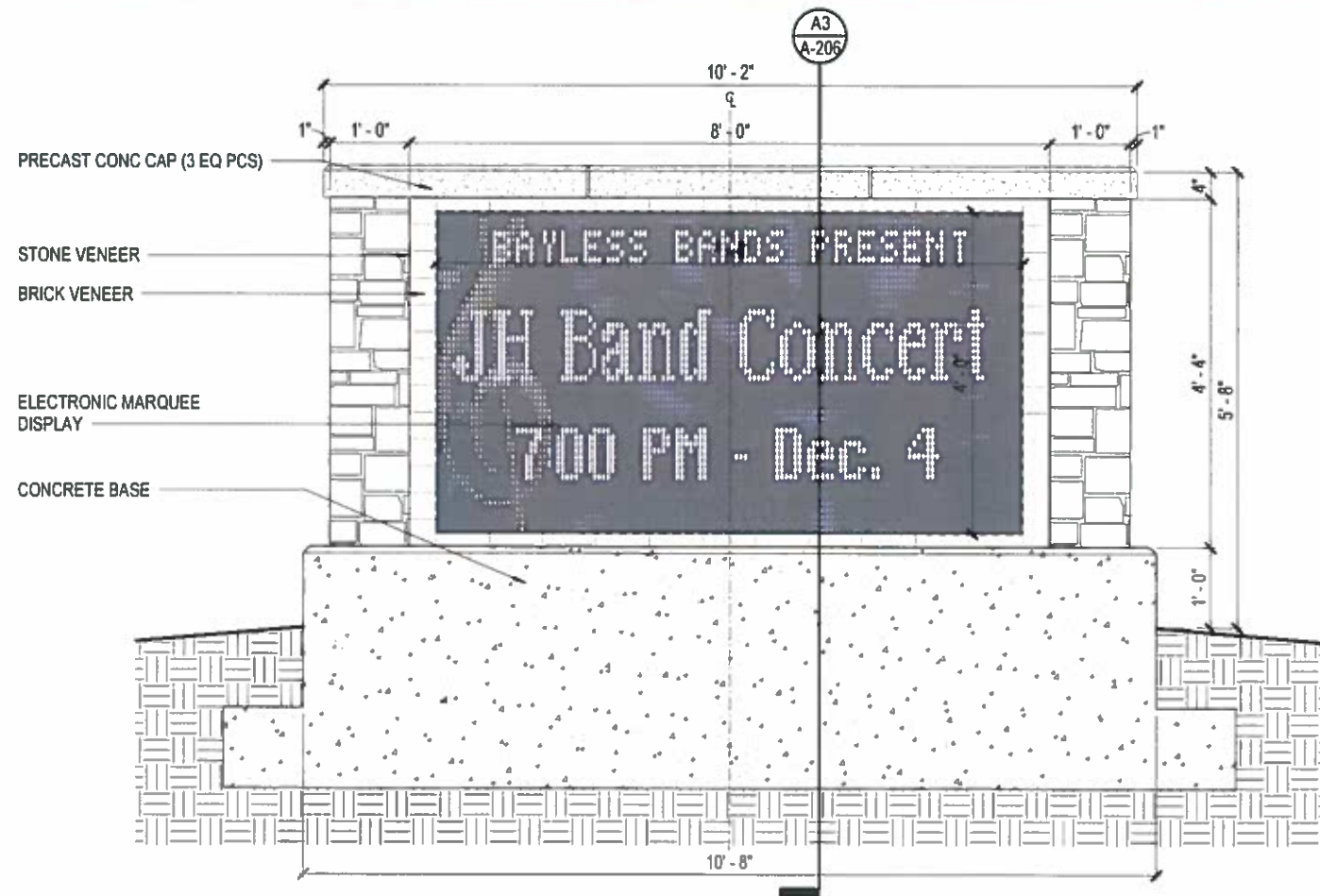

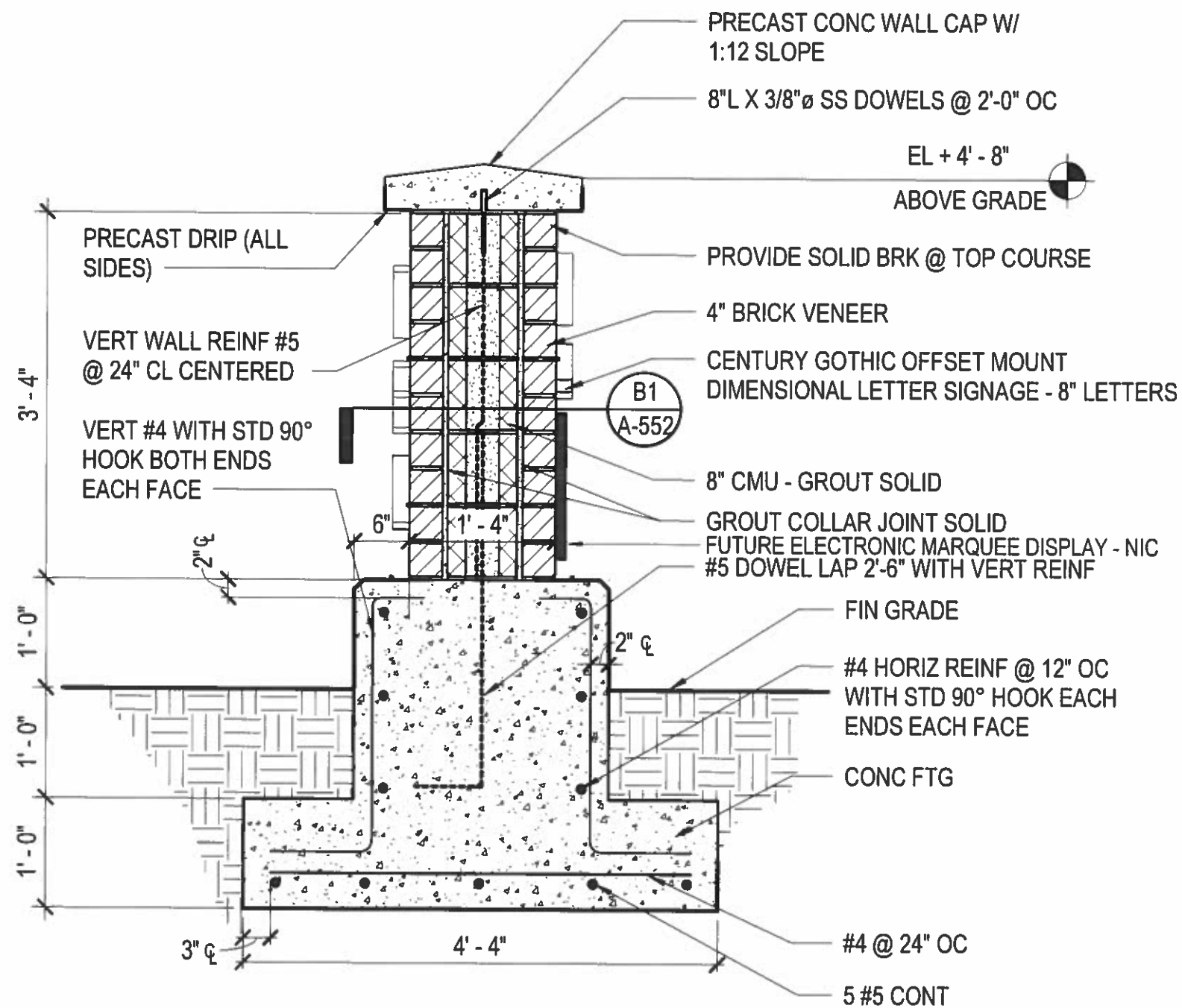

**EXISTING MONUMENT SIGN (SECTION)**

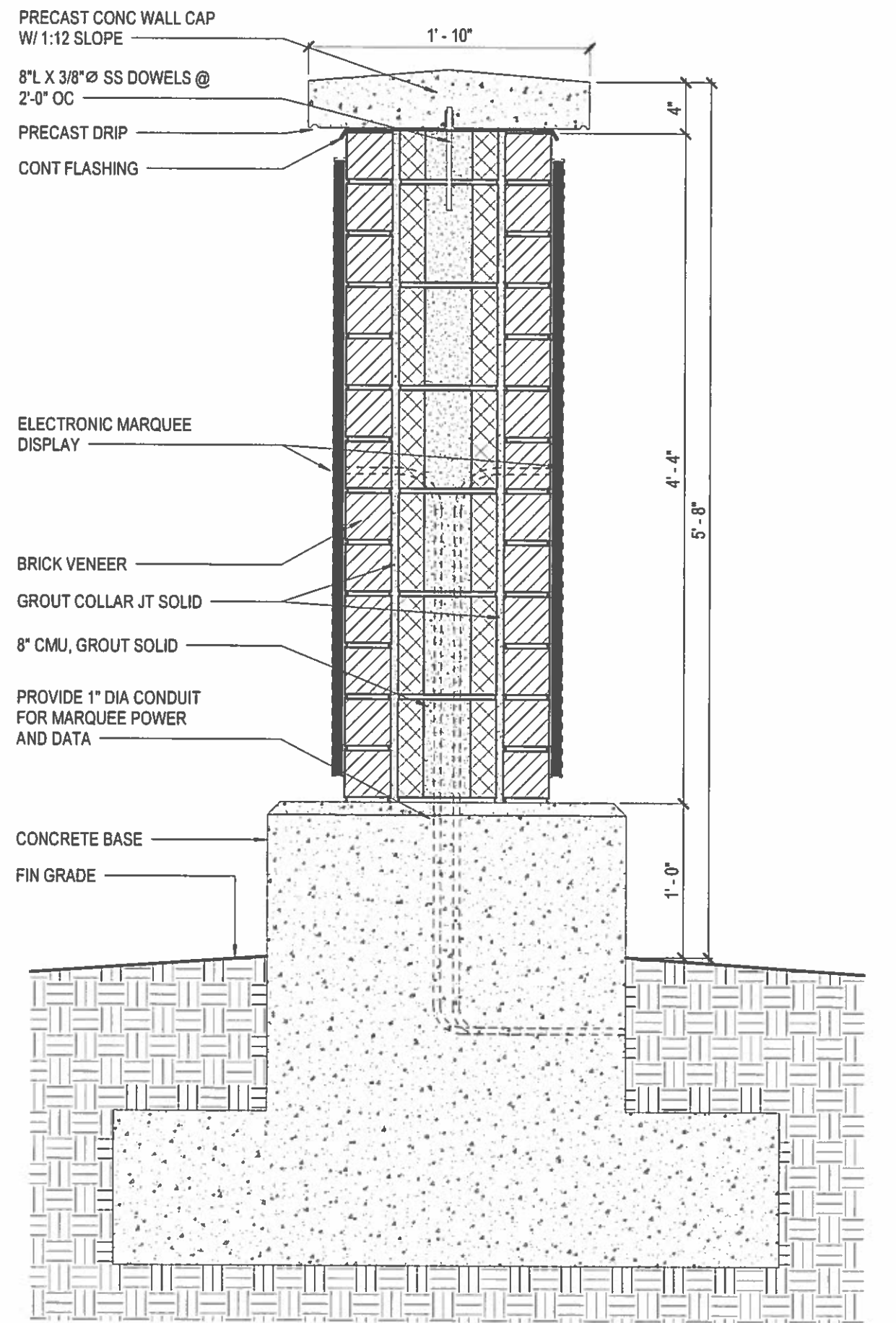

**ADDTL MONUMENT SIGN W/ DIGITAL DISPLAY (SECTION)**



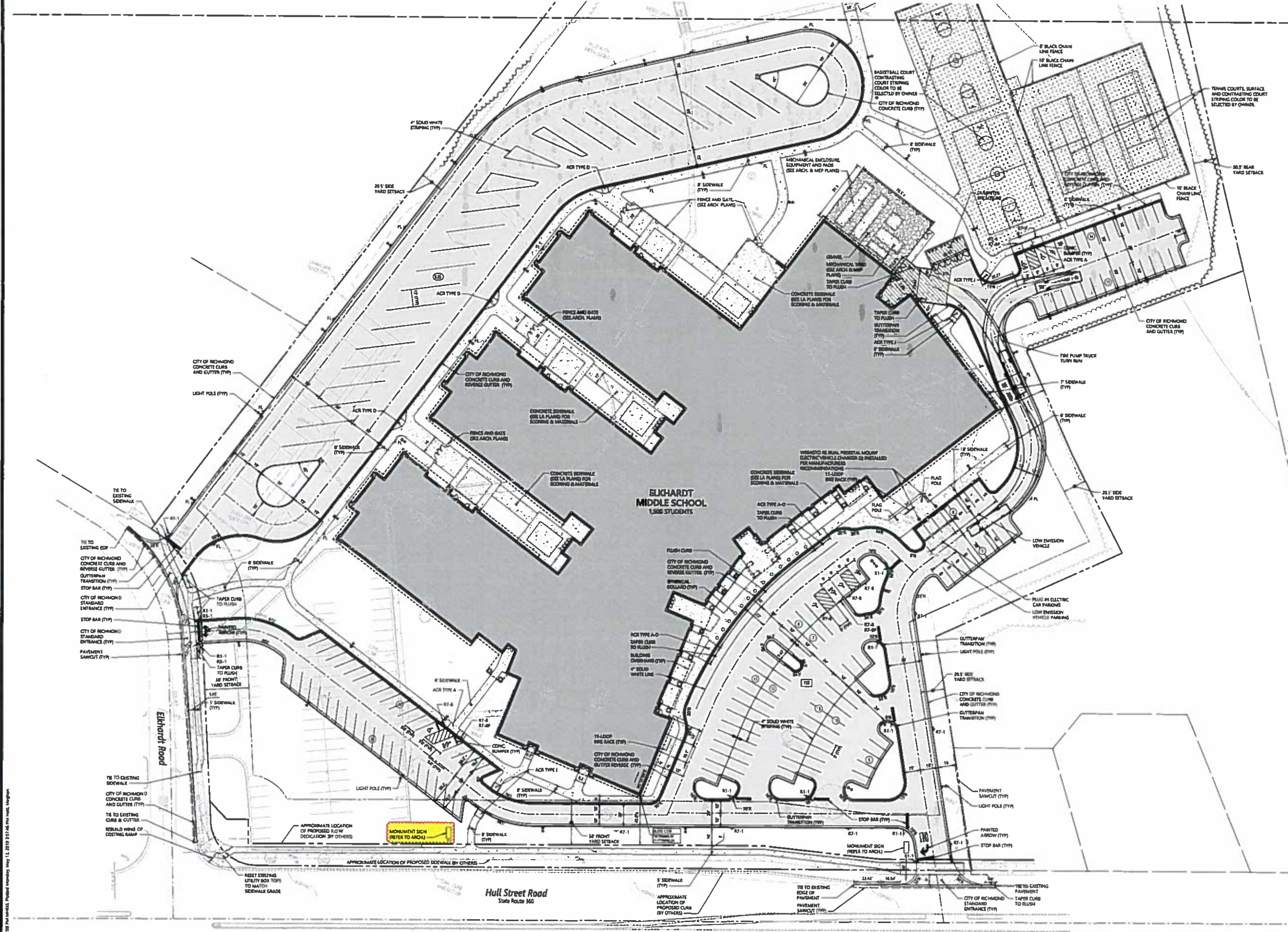

**vhb**  
 115 South 15th Street  
 Suite 200  
 Richmond, VA 23219  
 804.343.7100

REVISION 1	REVISION 2	DESCRIPTION
JPC	JPC	
3/22/2019	5/13/2019	
MAJOR	DATE	REVISIONS

DATE 02/02/2019  
 PROJECT 3447120  
 DESIGNED M. Agne  
 DRAWN M. Burck  
 CHECKED J. Wicks



**RRMM ARCHITECTS, PC**  
 1317 Executive Blvd, Suite 200  
 Chesapeake, Virginia 23320  
 (757) 522-2828



PROFESSIONAL ENGINEER  
 J. WICKS  
 Lic. No. 18071  
 VIRGINIA DEPARTMENT OF EDUCATION 15-108-05-100

PROJECT **ELKHART MIDDLE SCHOOL REPLACEMENT**  
**RICHMOND PUBLIC SCHOOLS**  
 600 HULL STREET ROAD  
 RICHMOND, VIRGINIA  
 DRAWING **LAYOUT AND MATERIALS PLAN**

SHEET  
**C4.01**