

INTRODUCED: September 26, 2016

AN ORDINANCE No. 2016-252

To authorize the Chief Administrative Officer, on behalf of the City of Richmond, to execute a Development and Cooperation Agreement and related documents between the City of Richmond and South Canal, LLC for the purposes of clearing title to properties owned by the parties, providing for access by the parties to their respective parcels, advancing the City’s Riverfront Plan and Master Plan, and stimulating economic development in the area generally bounded by Hull Street to the east, railroad tracks to the south and west, and the James River to the north.

Patron – Mayor Jones

Approved as to form and legality
by the City Attorney

PUBLIC HEARING: OCT 10 2016 AT 6 P.M.

THE CITY OF RICHMOND HEREBY ORDAINS:

§ 1. That the Chief Administrative Officer, on behalf of the City of Richmond, is hereby authorized to execute a Development and Cooperation Agreement between the City of Richmond and South Canal, LLC for the purposes of clearing title to properties owned by the parties, providing for access by the parties to their respective parcels, advancing the City’s Riverfront Plan and Master Plan, and stimulating economic development in the area generally bounded by Hull Street to the east, railroad tracks to the south and west, and the James River to the north, provided

AYES: _____ NOES: _____ ABSTAIN: _____

ADOPTED: _____ REJECTED: _____ STRICKEN: _____

that the Development and Cooperation Agreement shall first be approved as to form by the City Attorney and shall be substantially in the form of the document attached to this ordinance.

§ 2. That the Chief Administrative Officer, for and on behalf of the City of Richmond, is hereby authorized to execute those documents attached as exhibits to the aforementioned Development and Cooperation Agreement that require execution by the City, provided that such documents shall first be approved as to form by the City Attorney and shall be substantially in the form of the documents attached to this ordinance.

§ 3. This ordinance shall be in force and effect upon adoption.



CITY OF RICHMOND
INTRACITY CORRESPONDENCE

O & R REQUEST

SEP 9 2016
4-5659
Chief Administration Office
City of Richmond

O&R REQUEST

DATE: September 9, 2016
TO: The Honorable Members of City Council
THROUGH: Dwight C. Jones, Mayor (By Request)
THROUGH: Selena Cuffee-Glenn, Chief Administrative Officer
THROUGH: John Buturla, Interim Deputy Chief Administrative Officer, Operations
FROM: Lee Downey, Deputy Chief Administrative Officer, Planning & Economic Development
RE: DEVELOPMENT AND COOPERATION AGREEMENT BETWEEN THE CITY AND SOUTH CANAL, LLC

EDITION: 1
RECEIVED

SEP 15 2016

OFFICE OF CITY ATTORNEY

ORD. OR RES No. _____

PURPOSE: To adopt all ordinances necessary to effectuate and for the CAO to execute on behalf of the City (1) that certain Cooperation and Development Agreement between the City and South Canal attached hereto (the "Development Agreement") and (2) the various agreements and property transfers contemplated therein and attached thereto as exhibits, which include:

- 1. The Escrow Agreement attached as Exhibit I, which will provide for holding the Transaction Documents (i.e., the following documents) in escrow until such time that they may be released pursuant to the terms of the Development Agreement.
a. City to South Canal:
i. The Right of Entry Agreement attached as Exhibit H, which grants South Canal a right-of-entry onto city-owned property for the purposes of performing South Canal's obligations under the Development Agreement.
ii. The "City Land Deed" attached as Exhibit F, by which deed the City conveys to South Canal a portion of a city-owned parcel (Tax Parcel No. S0000052006), such portion being labeled the City Land Parcel on the Survey (Survey attached to the Development Agreement as Exhibit A).
b. South Canal to City:
i. The "Driveway Deed" attached as Exhibit D, by which deed South Canal conveys to the City fee simple interest to that certain parcel of land labeled the Driveway Parcel on the Survey.
ii. The "Canal Parcel and Flood Wall Parcel Quitclaim Deed" attached as Exhibit E, by which deed South Canal conveys to the City any interest it has, if any, to certain city-owned property described in such deed.

- iii. The “**Flood Wall Easements**” attached as Exhibit C, by which easements South Canal grants to the City (1) access to the flood wall and (2) a 15 foot no-build buffer from the southern face of the flood wall.
- iv. The “**Storm Water Easement**” attached as Exhibit G, by which easement South Canal grants to the City those right necessary to operate the current utility Facilities under the City Land Parcel (becomes necessary once the City Land Parcel is conveyed to South Canal).

REASON: The Development Agreement will (1) clear up property and title disputes between the City and South Canal, LLC, (2) provide for the replacement of an out-of-date bridge over the canal at no cost to the City, and (3) allow for South Canal to develop its property, furthering the investment in the Manchester area and increasing tax revenues for the City.

RECOMMENDATIONS: Recommend adoption of the ordinances necessary to effectuate the Development Agreement and the various agreements and transfers contemplated therein.

BACKGROUND: This project will provide the necessary land transfers and bridge reconstruction needed to provide developable land between the flood wall and the canal in the Manchester area of the City. The development agreement will clear up various issues related to land ownership and will provide for the construction of a new bridge to access the land and to access the flood wall for maintenance and repair.

The developer is also requesting a rezoning of the property and, combined with the development agreement will provide for significant future development of the parcel. The development will consist of a mixed use-development to provide residential opportunities and potential commercial development along with accompanying parking. The project will also cause the removal of the dilapidated structure currently on the property. Plans for the future development will go through the regular approval processes for the City.

Because of the complexity of the project, efforts have been underway for a few years to finalize this development agreement.

FISCAL IMPACT/COST: None anticipated.

FISCAL IMPLICATIONS: None anticipated.

BUDGET AMENDMENT NECESSARY: No amendment necessary at this time.

REVENUE TO CITY: None

DESIRED EFFECTIVE DATE: Upon Adoption.

REQUESTED INTRODUCTION DATE: September 26, 2016

CITY COUNCIL PUBLIC HEARING DATE: October 10, 2016

REQUESTED AGENDA: Consent Agenda.

RECOMMENDED COUNCIL COMMITTEE: Land Use, Housing and Transportation Committee

CONSIDERATION BY OTHER GOVERNMENTAL ENTITIES:

AFFECTED AGENCIES: Economic Development; Public Works; Planning and Community Development; Public Utilities; Assessor; Fire Department

RELATIONSHIP TO EXISTING ORD. OR RES.: None

REQUIRED CHANGES TO WORK PROGRAM(S): None.

ATTACHMENTS: Development and Cooperation Agreement

STAFF: Lee Downey, CAO Planning and Economic Development (804)-646-4848

THIS INSTRUMENT IS EXEMPT FROM RECORDATION TAX
PURSUANT TO THE PROVISIONS OF VA. CODE § 58.1-811.

Consideration: \$ n/a
Tax Assessment: \$ _____

PREPARED BY AND RETURN TO:

Richard W. Gregory, Esquire

Atlas Law, PLC

7 East Second Street

Richmond, Virginia 23224

GPIN Numbers: S0000101010, S0000052006, S0000052009, and S0000052017

DEVELOPMENT
AND
COOPERATION AGREEMENT

Among

THE CITY OF RICHMOND,

A municipal corporation of the Commonwealth of Virginia

and

SOUTH CANAL, LLC, A Virginia limited liability company,

With respect to tax map parcels:

S0000101010

S0000052006

S0000052009

S0000052017

dated,

_____, 2016

TABLE OF CONTENTS

DEVELOPMENT AND COOPERATION AGREEMENT

1. Development and Cooperation Agreement
2. Exhibit A - Survey
3. Exhibit B – Site Plan
4. Exhibit C – Flood Wall Easements (South Canal to City--Flood Wall Access and Buffer)
5. Exhibit D –Driveway Deed (South Canal to City)
6. Exhibit E – Canal Parcel and Flood Wall Parcel Quitclaim Deed (South Canal to City)
7. Exhibit F – City Land Deed (City to South Canal)
8. Exhibit G – Storm Water Easement (South Canal to City)
9. Exhibit H – Right of Entry Agreement
10. Exhibit I – Escrow Agreement
11. Exhibit J – Bridge Requirements and Conceptual Plans
12. Exhibit K – Fire and Safety Lane Plans

DEVELOPMENT AND COOPERATION AGREEMENT

This DEVELOPMENT AND COOPERATION AGREEMENT (the "Agreement"), made this ___ day of _____, 2016 by and among **THE CITY OF RICHMOND**, a municipal corporation of the Commonwealth of Virginia ("City"), and **SOUTH CANAL, LLC**, a Virginia limited liability company ("South Canal"), together with its successor and assign, recites and provides as follows:

RECITALS:

A. Attached hereto as **Exhibit "A"** is a survey which shall be recorded as an exhibit hereto (the "Survey"), entitled "COMPILED EXHIBIT showing SOUTH CANAL DEVELOPMENT," Sheet 1 of 1, Job No. 56160036.00, prepared by Balzer and Associates, certified land surveyor, and dated June 1, 2016, which plots the boundary lines of certain parcels referred to herein, which currently exist or which are to be relocated as provided herein. A site plan drawing to aid in illustrating the agreements contained herein is attached hereto as **Exhibit "B"**.

B. South Canal is the fee simple owner of the following property:

1. Development Parcel. That certain parcel of real property consisting of approximately 1.71 acres, together with the improvements thereon and the appurtenances thereunto belonging, designated as Tax Map Parcel No. S0000052017, which it acquired from Fountainhead Acquisitions, LLC, by that certain Deed of Contribution, dated March 13, 2012, and recorded March 16, 2012, in the Clerk's Office, Circuit Court, City of Richmond, Virginia ("Clerk's Office"), as Instrument Number 12-5010 (the "South Canal Parcels Deed"), which property is more particularly described on the Survey as Parcel C (the "Development Parcel").

2. Driveway Parcel. That certain parcel of real property consisting of approximately 0.197 acre, together with the improvements thereon and the appurtenances thereunto belonging, designated as Tax Map Parcel No. S0000052009, which it acquired from Fountainhead Acquisitions, LLC, by the South Canal Parcels Deed, which property is more particularly described on the Survey as Parcel B (the "Driveway Parcel").

C. City is the fee simple owner of the following property:

1. Full Canal Parcel. That certain parcel of real property consisting of approximately 5.8 acres, together with any and all improvements located thereon and the appurtenances thereunto belonging, including but not limited to the Manchester Canal, the canal bank, and the Old Bridge, as defined herein, designated as Tax Map Parcel No. S0000101010. For the purposes of this Agreement, the term "Canal Parcel" shall refer to that portion of the Full Canal Parcel from Hull Street on the east to the point at which the Norfolk Southern's rail line crosses the Full Canal Parcel on the its west, the northern boundary of which abuts the Flood Wall Parcel and Development Parcel and the southern boundary of which abuts the Driveway Parcel, and Tax Map Parcel Nos. S0000052001 (owned by the City) and S0000023001 (owned by Norfolk Southern Railway Co.). The City acquired the Canal Parcel from Virginia Electric and Power Company by that certain Special Warranty Deed, dated June 9, 1989, recorded June 16, 1989, in Deed Book 205 at page 212, in the Clerk's Office, being only a portion of the property conveyed to the City by such Special Warranty Deed (the remainder of real property conveyed by such Special Warranty Deed being a portion of the Flood Wall Parcel).

2. Flood Wall Parcel. That certain parcel of real property consisting of approximately 3.81 acres, together with any and all improvements located thereon and the appurtenances thereunto belonging, including but not limited to a flood wall (the "City Flood Wall"), designated as Tax Map Parcel No. S0000052006, such parcel being comprised of the following:

(i) All that certain real property the City acquired from Ross Investment Corporation, and any other owners thereof, by that certain Order Directing the Recordation of the Vesting of Title, dated September 29, 1987, recorded on October 6, 1987, in Deed Book 143 at page 1265, in the Clerk's Office; and

(ii) All that certain real property the City acquired from Manchester Board and Paper Company, Inc. by that certain Deed, Deed of Easement, and Deed of Partial Release, dated January 11, 1988, recorded February 11, 1988, in Deed Book 156 at page 897, in the Clerk's Office; and

(iii) All that certain real property the City acquired from ReeTree Partnership, etc., et al., and any other owners thereof, by that certain Order Directing the Recordation of the Vesting of Title, dated September 29, 1987, recorded on October 6, 1987, in Deed Book 143 at page 1271, in the Clerk's Office; and

(iv) A portion of that certain real property the City acquired from Virginia Electric and Power Company by that certain Special Warranty Deed, dated

June 9, 1989, recorded June 16, 1989, in Deed Book 205, at page 212 in the Clerk's Office (the remainder of real property conveyed by such Special Warranty Deed being the Canal Parcel).

*For the purposes of this Agreement, two portions of the Flood Wall Parcel shall be referenced as follows:

“Diversity Park” designated as Subparcel A-1 on the Survey; and

“City Land” designated as Subparcel A-2 on the Survey and described more particularly thereon. A portion of the City Land shall constitute a portion of the Flood Wall Buffer Area as shown and designated as such on the Survey.

D. A concrete vehicular bridge (the “Old Bridge”) is located upon the Canal Parcel, which bridge is partially supported by an abutment on the Driveway Parcel, all as shown on the Survey and which bridge South Canal intends to remove and replace with a precast replacement concrete bridge for the benefit of the City and the public (the “Replacement Bridge”) in exchange for (i) the City's conveyance of the City Land; and (ii) certain other agreements contained herein.

E. South Canal intends, but is not specifically obligated, to develop the Development Parcel and the City Land parcel as a mixed-use project (“Proposed Project”). It is anticipated that the Proposed Project will be built with construction of Phase 1 beginning in early 2017, and construction of Phase 2, depending on market conditions, beginning in 2019. It is currently anticipated that Phase 1 will be a mid-rise, mixed-use, tower with up to sixteen (16) stories, inclusive of 2-4 stories of structured parking deck and roof items. It is currently anticipated that Phase 2 and perhaps a third phase will likely include mixed-use situated upon multiple levels of structured parking.

F. When the City Flood Wall was constructed in 1988, the City and South Canal's predecessor in title to the Development Parcel and the Driveway Parcel, Manchester Board and Paper Co., entered into a Cooperation Agreement, dated January 28, 1988, recorded in the Clerk's Office, in Deed Book 0156, at page 0910 (the “Cooperation Agreement”) and a Deed, Deed of Easement, and Deed of Partial Release, dated January 11, 1988, recorded in the Clerk's Office in Deed Book 0156, at page 0897 (the “Manchester Paper and Board Deed”) (collectively, the “1988 Documents”), which documents conveyed a portion of the Flood Wall Parcel to the City and intended to also provide for, among other things, perpetual access by the City to and from the Flood Wall Parcel and perpetual access by the owner of the Development Parcel to and from a public right of way for certain purposes (then and now, Hull Street).

G. The 1988 Documents did not grant the City a perpetual right of access over and across over the Driveway Parcel and did not grant the owner of the Development Parcel a perpetual right of access suitable for the Proposed Project to and from a public right of way.

H. South Canal's claims a right to access the Development Parcel via a street along the northern banks of the canal over the Canal Parcel originating from an 1869 lease, recorded in the Clerk's Office, Circuit Court, County of Chesterfield, Virginia and references thereto in subsequently recorded documents in South Canal's chain of title, which claim and right the City disputes, leaving some doubt as to the existence of said street and the nature of South Canal's right of access via this route. Moreover, the City physically impeded access via this route when it planted trees there as part of the creation of Diversity Park.

I. South Canal's claimed right to access the Development Parcel via the Old Bridge is also disputed by the City, which owns the land under the Old Bridge (i.e., the Canal Parcel). But South Canal claims the Old Bridge itself appears to have been built by South Canal's predecessor in title in about 1936 and to have been used exclusively for access to the Development Parcel for decades, which use South Canal claims may have created rights to a prescriptive easement benefiting the Development Parcel.

J. In addition to conveying the Development Parcel and Driveway Parcel, the South Canal Parcels Deed, in error, purports to convey certain property located on the Flood Wall Parcel, which property could not be conveyed by the South Canal Parcels Deed because at the time of the execution and recordation of such deed, such property was owned (and remains owned) in fee simple by the City, being previously conveyed to the City by such duly executed and recorded deeds set forth in subsection (C)(2) of these Recitals.

K. In the spirit of cooperation between the parties and as contemplated by the 1988 Documents, South Canal and the City now desire to enter into this Development Agreement (i) to avoid the cost and delay of litigation to clear any clouds on title which the parties hereto have asserted, (ii) to settle all unresolved disputes and issues regarding their respective parcels, (iii) to provide for the parties access to their respective parcels, (iv) to advance the City's Riverfront Plan and Master Plan; (v) to stimulate economic development; and (vi) to otherwise facilitate the parties' enjoyment of their respective properties as provided herein.

L. South Canal is entering into this Agreement with the intent of constructing buildings, the construction of which are dependent upon the City: (i) dedicating the Replacement Bridge to public use and travel to provide access from Hull Street to the Proposed Project,

and (ii) to grant a rezoning to B-4 for the Proposed Project ("Land-Use Pre-Requisites"). Concurrently herewith, an application for rezoning has been submitted and South Canal is relying upon the representatives of the City to act promptly and in good faith on all planning and zoning requests; and to expedite review for all building permit applications and inspections associated with the subject property to the extent practical and permitted by applicable law.

AGREEMENT:

NOW, THEREFORE, for and in consideration of one dollar (\$1.00), the mutual covenants contained herein, and other good and valuable consideration, the receipt and sufficiency of which are hereby acknowledged, the parties hereto agree as follows:

1. RECITALS. The above recitals are acknowledged by all parties hereto to be true, correct and complete to the best of their knowledge and are incorporated herein by reference.

2. TRANSACTION DOCUMENTS. The parties hereto desire to provide for the orderly development, operation, maintenance, repair, and access to and from all of the properties mentioned above by such properties' respective owners and to that end agree, subject to the terms and conditions contained herein, to execute and deliver the following agreements pursuant to the terms of this Development Agreement in each and every instance where such entity is a party to such agreement(s) (collectively the "Transaction Documents"):

A. City Flood Wall Buffer and Access Agreement and Deed of Easements in substantially the form attached hereto as **Exhibit "C"** (the "**Flood Wall Easements**") granting the City an easement that (1) grants the City access to the Flood Wall via a route across the Development Parcel of sufficient dimensions and with the required weight bearing capacity to serve the inspection and maintenance needs of the City and the Army Corps of Engineers, provided, however, South Canal retains the right to relocate such easement as necessary to accommodate the needs of the Proposed Project upon sixty (60) days' notice to the City, and (2) grants the City access to the Flood Wall Buffer Easement Area, as shown on the Survey, providing an area for maintenance of the City Flood Wall and no-build buffer between the City Flood Wall and the Proposed Project and any other development.

B. Special Warranty Deed in substantially the form attached hereto as **Exhibit "D"** (the "**Driveway Deed**") which conveys the Driveway Parcel from South Canal to the City, upon which parcel the City will dedicate a public right of way.

C. Deed of Quit Claim in substantially the form attached hereto as **Exhibit "E"** (the "**Canal Parcel and Flood Wall Parcel Quitclaim Deed**") which conveys from South Canal to the City any easements or other rights which South Canal may have to the City's Canal Parcel, including the Old Bridge, and to the City's Flood Wall Parcel less and except the City Land Parcel.

D. Special Warranty Deed in substantially the form attached hereto as **Exhibit "F"** ("**City Land Deed**") which conveys from the City to South Canal the City Land Parcel.

E. Deed of Sewer and Water Utility Easement in substantially the form attached hereto as **Exhibit "G"** ("**Storm Water Easement**").

F. **Right-of-Entry Agreement** in substantially the form attached hereto as **Exhibit "H"**

3. **DEVELOPMENT AGREEMENT EXECUTION.** Within twenty (20) days of City Council for the City of Richmond's ("City Council") adoption of an ordinance authorizing the City's execution of this Agreement, this Agreement shall be fully executed by both parties and recorded by South Canal at its cost and expense along with all unexecuted Exhibits hereto in the Clerk's Office and indexed in the land records.

4. **ESCROW.** Upon execution of the Agreement, the City and South Canal shall execute an escrow agreement in substantially the form attached hereto as **Exhibit "I"** ("**Escrow Agreement**") between the City, South Canal, and a third-party escrow agent chosen by South Canal (the "Escrow Agent"). The Escrow Agent shall be eligible to act as a "settlement agent" pursuant to Virginia Code § 55-525.19. At Closing, all of the fully executed and notarized Transaction Documents shall be delivered to the Escrow Agent to be held in escrow and released, recorded (as applicable), and delivered as set forth in this Agreement and the Escrow Agreement. Each Transaction Document shall be of no force and effect until such time it is released from Escrow and recorded pursuant to the Escrow Agreement. Notwithstanding the foregoing, if as of the date the parties execute the Agreement, City Council has not adopted the necessary ordinances to authorize all of the Transaction Documents, then the date in which the City and South Canal shall deliver the Transaction Documents to the Escrow Agent shall be within twenty (20) days of Council's authorization of all the Transaction Documents.

5. **SOUTH CANAL OBLIGATIONS.** South Canal's obligations under this Agreement, pursuant and subject to the terms of this Agreement, are as follows:

A. South Canal shall demolish the Old Bridge and replace it with the Replacement Bridge, which shall be substantially in conformance with the requirements and conceptual plans attached hereto as **Exhibit J** (together, the "Bridge Requirements and Conceptual Plans") as modified by the Preliminary Bridge Plans and the Final Bridge Plans, as defined herein, approved in writing by the City's Director of Public Works or his designee ("DPW").

(i) Prior to commencing with the demolition of the Old Bridge and the installation of the Replacement Bridge, South Canal shall:

(1) Submit proposed preliminary bridge plans to DPW, in a form acceptable to DPW, showing South Canal's demolition plans for the Old Bridge and proposed bridge plans for the Replacement Bridge (as approved, the "Preliminary Bridge Plans"). Along with the proposed preliminary bridge plans, South Canal shall submit the following, which shall show how the proposed preliminary bridge plans meet the requirements set forth in the Bridge Requirements and Conceptual Plans:

- (a) Design computations.
 - (b) Bridge load ratings.
 - (c) Geotechnical report--foundations.
 - (d) Hydraulic and Hydrologic Analysis and Drainage Analysis.
- (3) Proposed relocation/realignment of utilities currently attached to bridge.

Upon receipt of South Canal's proposed preliminary bridge plans in a form acceptable to DPW and including all documents required by this Agreement and DPW, DPW shall respond to South Canal within 15 business days with either written approval or denial. In this case of denial, DPW shall list the reasons for the denial.

(2) Following approval of the Preliminary Bridge Plans, submit proposed final bridge plans to DPW, in a form acceptable to DPW, showing South Canal's final plans for the Replacement Bridge (as approved, the "Final Bridge Plans"). South Canal shall not commence with the demolition of the Old Bridge or the installation of the Replacement Bridge until DPW approves the Final Bridge Plans. Upon receipt of South Canal's proposed final bridge plans, DPW shall respond to South Canal within 15 business days with either written approval or denial. In the case of denial, DPW shall list the reasons for the denial. If the proposed final bridge plans are substantially in conformance with the Preliminary Bridge Plans, then DPW shall not unreasonably deny approval thereof. To the extent the Final Bridge Plans differ from the Preliminary Bridge Plans, the Final Bridge Plans shall take precedence.

(3) Procure insurance in the form and coverage amount required by the Right-of-Entry Agreement and provide the City with certificate of insurance evidencing compliance with the requirement.

(4) Obtain all permits and approvals required by the City.

(5) Obtain all permits and approvals required by the Army Corps of Engineers, the Commonwealth of Virginia, and any other applicable agency.

(ii) South Canal shall notify the City at least 10 business days in advance of the date on which South Canal anticipates completing the Replacement Bridge. Upon completion, South Canal shall submit to the City the following (the "Bridge Completion Documents"):

- (a) Design computations including load ratings performed in AASHTOWare BRR.

- (b) As-built drawings.
- (c) Original CADD files.
- (d) Final log books, which shall be maintained throughout the demolition of the Old Bridge and construction of the Replacement Bridge.
- (e) Material testing reports and source of materials.
- (f) National Bridge Safety Inspection (NBSI) report.
- (g) Certification of construction inspection report certified by professional engineer.

Following receipt of the Bridge Completion Documents, the City may inspect the Replacement Bridge for its conformance with the Final Bridge Plans and for its suitability to protect the health, safety, and welfare of the public and, if so satisfied, accept the Replacement Bridge. If the City determines the Replacement Bridge is not in conformance with the Final Bridge Plans or is otherwise not suitable to protect the health, safety, and welfare of the public, the City shall inform South Canal in writing of its objections within 15 business days of DPW's receipt of the Bridge Completion Documents. If the City does not provide South Canal of such objections within 15 business days of DPW's receipt of the Bridge Completion Documents, then the Replacement Bridge shall be deemed approved and accepted by the City.

(iii) Upon City approval and acceptance of the Replacement Bridge, it becomes property of City. Provided, however, South Canal hereby warrants that the Replacement Bridge shall be constructed in a good and workmanlike manner in conformity with the Final Bridge Plans, and will be otherwise free of defects for 365 days following the City's acceptance (the "Warranty Period") and that South Canal shall repair at its own cost and expense any defects discovered or arising during the Warranty Period.

B. South Canal shall construct an enforced grass-covered lane for fire and safety vehicles in a location approved in writing by DPW across Diversity Park from Hull St. to the Development Parcel (the "Fire and Safety Lane"). The Fire and Safety Lane shall be in substantial conformance with the specifications attached hereto as **Exhibit K** (the "Fire and Safety Lane Plans").

(i) Prior to commencing with the construction of the Fire and Safety Lane and prior to installing any utilities under Diversity Park, South Canal shall:

- (1) Receive the written approval for the location of the Fire and Safety Lane from the City.

(2) Procure insurance in the form and coverage amount required by the Right-of-Entry Agreement and provide the City with certificate of insurance evidencing compliance with the requirement.

(3) Obtain all permits and approvals required by the City, the Army Corps of Engineers, and any other applicable agency.

(ii) South Canal shall notify the City at least 10 business days in advance of the date in which South Canal anticipates completing the Fire and Safety Lane. Upon completion, the City may inspect the Fire Safety Lane for its conformance with the Plans and for its suitability to protect the health, safety, and welfare of the public and, if so satisfied, accept the Fire Safety Lane. If the City determines the Fire Safety Lane is not in conformance with the Plans or is otherwise not suitable to protect the health, safety, and welfare of the public, the City shall inform South Canal in writing of its objections within 15 business days of completion. If the City does not provide South Canal of such objections within 15 business days of completion, then the Fire Safety Lane shall be deemed approved and accepted by the City.

C. South Canal shall convey the Driveway Parcel to the City via the Driveway Deed.

D. South Canal shall quitclaim its rights, if any, in the Canal Parcel, including the Old Bridge, and the Flood Wall Parcel, less and except the City Land Parcel, to the City via the Canal Parcel and Flood Wall Parcel Quitclaim Deed.

E. South Canal shall grant the City access across the Development Parcel and access to the City Flood Wall via the Flood Wall Easements.

F. Immediately upon South Canal's acquisition of the City Land, South Canal shall grant the City the Storm Water Easement.

G. At the time of its construction of the Replacement Bridge, South Canal shall construct a turn-around facility in an area next to the north end of the Replacement Bridge to facilitate passenger vehicle U-turns.

H. At the time of its development of the Proposed Project, South Canal shall construct an approved hammerhead-style turn-around for a full-size "hook and latter" fire safety truck somewhere on the Development Parcel to facilitate such vehicles reversal of direction from the site.

I. South Canal acknowledges that the roadway currently on the Driveway Parcel is not in a condition suitable to serve the Proposed Project. South Canal agrees that prior to or simultaneous with developing the Proposed Project, it shall improve the roadway to such standards set forth by DPW as suitable for the Proposed Project, including, but not limited to, paving and installing sidewalks, curb, and gutter. Such improvements shall be completed by South Canal prior to its finalizing any portion of the Proposed Project.

6. CITY OBLIGATIONS. The City's obligations under this Agreement, pursuant and subject to the terms of this Agreement are as follows:

- A. The City shall convey the City Land to South Canal via the City Land Deed.
- B. The City shall grant South Canal a right-of-entry allowing South Canal to enter and access the Canal Parcel and Diversity Park for demolition of the Old Bridge and construction of the Replacement Bridge and the construction of the Fire and Safety Lane.
- C. The City shall open as a public right-of-way a street from Hull Street across the Driveway Parcel, the Replacement Bridge, and the Canal Parcel to the boundary of the Development Parcel upon acceptance of Replacement Bridge and acquisition of the Driveway Parcel.

7. RELEASE AND EFFECT OF TRANSACTION DOCUMENTS. The Transaction Documents shall not take effect until released and recorded by the Escrow Agent in accordance with the following:

- A. Right of Entry. The Right of Entry Agreement is necessary for the construction of the Replacement Bridge and Fire Safety Lane and shall be released upon City approval of Final Bridge Plans and the Fire and Safety Lane location.
- B. City Land Deed. The City Land Deed shall be released and recorded upon completion and the City's acceptance of the Replacement Bridge and the Fire and Safety Lane.
- C. Driveway Deed, Canal Parcel Deed and City Access Easement. The Driveway Deed, Canal Parcel and Flood Wall Parcel Quitclaim Deed, Storm Water Easement, and Flood Wall Easements shall be released and recorded immediately following the release and recordation of the City Land Deed.

8. LAND USE PRE-REQUISITE. South Canal shall not be required to demolish the Old Bridge nor build the Replacement Bridge unless and until City Council adopts the necessary ordinance(s) to re-zone the Development Parcel to B-4. Notwithstanding the foregoing, nothing herein shall be deemed to obligate the City to re-zone the Development Parcel and the City's failure to do so shall not be a breach of this Agreement.

9. TERMINATION. If South Canal does not complete the construction of the Replacement Bridge and the Fire and Safety Lane within 36 months of the execution of this Agreement, then either party may terminate by providing 30 day's written notice to the other party. Upon such termination, all Transaction Documents shall be deemed null and void.

10. FURTHER ASSURANCES. To the extent permitted by law, the City and South Canal agree to grant such further assurances and to execute such instruments as may be reasonably necessary to confirm the agreements expressed and granted herein.

11. DEFAULT. If either party shall fail to comply with any term, provision or covenant of this Agreement, and shall not cure such failure within thirty (30) days after written notice thereof

by the non-defaulting party, then the party failing to comply with any term, provision or covenant of this Agreement shall be in default of this Agreement provided, however, that if said term, provision or covenant to be performed is of such nature that same cannot reasonably be performed within such thirty (30) day period, such failure shall not constitute a default if the defaulting party commences such performance to cure said default within said thirty (30) day period and thereafter diligently undertakes to complete the same as reasonably determined by the non-defaulting party.

12. REMEDIES. If any party ("Defaulting Party") defaults in its responsibilities set out herein, ("Non-Defaulting Party") shall have the right to cure the default, which it is hereby agreed shall be at the Defaulting Party's expense, and Non-Defaulting Party may pursue all available remedies against Defaulting Party at law and equity for any costs and damages incurred. Additionally, Non-Defaulting Party may also terminate this Agreement.

13. SUBJECT TO APPROPRIATION. Any payments and other performances by the City under this Agreement or any agreement contemplated hereby is subject to annual or periodic appropriations by the City Council of the City of Richmond, Virginia. It is understood and agreed between the City and South Canal that the City shall be bound hereunder only to the extent of the funds available or which may hereafter become available for the purposes of performing under this Agreement. Under no circumstances shall the City's total liability under this Agreement exceed the total amount of funds appropriated by the City Council of the City of Richmond, Virginia, for the City's performance of this Agreement.

14. MISCELLANEOUS. The parties hereto agree that this Agreement shall be recorded in the Clerk's Office at South Canal's cost and expense. This Agreement in its entirety shall inure to the benefit of and shall be binding upon the parties hereto and their respective successors and assigns. Any amendments hereto shall be in writing and shall be signed by all parties hereto. This Agreement, together with all agreements referred to herein, represents the entire agreement between the parties with respect to the subject matter hereof. The covenants and agreements contained in this Agreement shall run with the land and shall be binding upon any and all succeeding land owners, their personal representatives, estates, heirs, devisees, assigns or successors in interest or any other parties having or taking an interest in or to the property covered by this Agreement. No party hereto shall be deemed to have waived the exercise of any right which it holds hereunder unless such waiver is made expressly and in writing. No determination by any court, governmental or administrative body or agency or otherwise that any provision of this Agreement or any amendment hereof is invalid or unenforceable in any instance shall affect the validity or enforceability of (a) any other provision hereof, or (b) such provision in any circumstance not controlled by such determination. Each such provision shall remain valid and enforceable to the fullest extent allowed by, and shall be construed wherever possible as being consistent with applicable law. This Agreement shall be given effect and construed by application of the laws of the Commonwealth of Virginia.

15. SEVERABILITY. If any provision of the Transaction Documents, or any application of any such provision to any party or circumstances, shall be determined by any court of competent jurisdiction to be invalid and unenforceable and such invalidity or unenforceability does not affect the basis of the bargain between the parties, then the remainder of this Agreement and the application of such provisions to the parties and to the Transaction Documents or the application of such provisions to such person or circumstances, other than the application as to which such

provision is determined to be invalid or unenforceable, shall not be affected thereby, and each provision shall be valid and shall be enforced to the fullest extent permitted by law.

16. COOPERATION AGREEMENT. The provisions hereof supersede, effective on the date of Closing and final consummation and recordation, as applicable, of all agreements provided for herein, the terms and provisions of the Cooperation Agreement to the extent such terms are inconsistent herewith.

17. SIGNATURE AUTHORITY. Except where specifically provided herein, the Chief Administrative Officer for the City of Richmond or the designee thereof may provide any authorization, approvals, and notices contemplated herein on behalf of the City.

[Signatures appear on the following pages.]

[South Canal's Signature Page to Development and Cooperation Agreement]

WITNESS the following signatures,

SOUTH CANAL, LLC,
A Virginia limited liability company

By: _____

Its: _____

ACKNOWLEDGMENT

COMMONWEALTH OF VIRGINIA)
) **TO WIT:**
CITY OF RICHMOND:)

I HEREBY CERTIFY, that on this ____ day of _____, 2016, before me, the subscriber, a Notary Public of the State aforesaid, personally appeared Richard W. Gregory, known to me, or satisfactorily proven to be, the person whose name is subscribed to the within instrument, and who acknowledged to be the Authorized Representative of SOUTH CANAL, LLC, a Virginia limited liability company, and acknowledged that execution of the foregoing instrument for the purposes therein contained and acknowledged the same to be the lawful act and deed of the aforesaid company.

AS WITNESS my hand and Notarial Seal the day and year first above written.

NOTARY PUBLIC

My Commission Expires:_____

Registration No.:_____

[City's Signature Page to Development and Cooperation Agreement]

CITY OF RICHMOND, VIRGINIA,
 a municipal corporation of the Commonwealth of Virginia

By: _____
 Sclena Cuffee-Glenn

Its: Chief Administrative Officer

ACKNOWLEDGMENT

COMMONWEALTH OF VIRGINIA)	
)	TO WIT:
CITY OF RICHMOND:)	

I HEREBY CERTIFY, that on this ___ day of _____, 2016, before me, the subscriber, a Notary Public of the State aforesaid, personally appeared SELENA CUFFEE-GLENN, known to me, or satisfactorily proven to be, the person whose name is subscribed to the within instrument, and who acknowledged to be the Chief Administrative Officer of the City of Richmond, Virginia, a municipal corporation of the Commonwealth of Virginia, and acknowledged that execution of the foregoing instrument for the purposes therein contained and acknowledged the same to be the lawful act and deed of the aforesaid corporation.

AS WITNESS my hand and Notarial Seal the day and year first above written.

 NOTARY PUBLIC

My Commission Expires: _____

Registration No.: _____

Approved as to Form:



 City Attorney's Office



EXHIBIT A
TO
DEVELOPMENT AND COOPERATION AGREEMENT

Survey

[Attached Hereto]

EXHIBIT B
TO
DEVELOPMENT AND COOPERATION AGREEMENT



Site Plan

[Attached Hereto]



EXHIBIT ONLY

EXHIBIT B
To Div. Agreement



FLOOD WALL PARCEL-CITY

-  SUB PARCEL A-1 DIVERSITY PARK
-  SUB-PARCEL A-2 CITY LAND PARCEL
-  SUB-PARCEL A-3 FLOOD WALL BUFFER EASEMENT

DEVELOPMENT PARCELS-SOUTH CANAL, LLC

-  PARCEL B DRIVEWAY PARCEL
-  PARCEL C DEVELOPMENT PARCEL

MANCHESTER PARCEL - CITY

-  SUB PARCEL D-1 MANCHESTER CANAL WATER
-  SUB PARCEL D-2 MANCHESTER CANAL BANK

2 JAMES RIVER 2

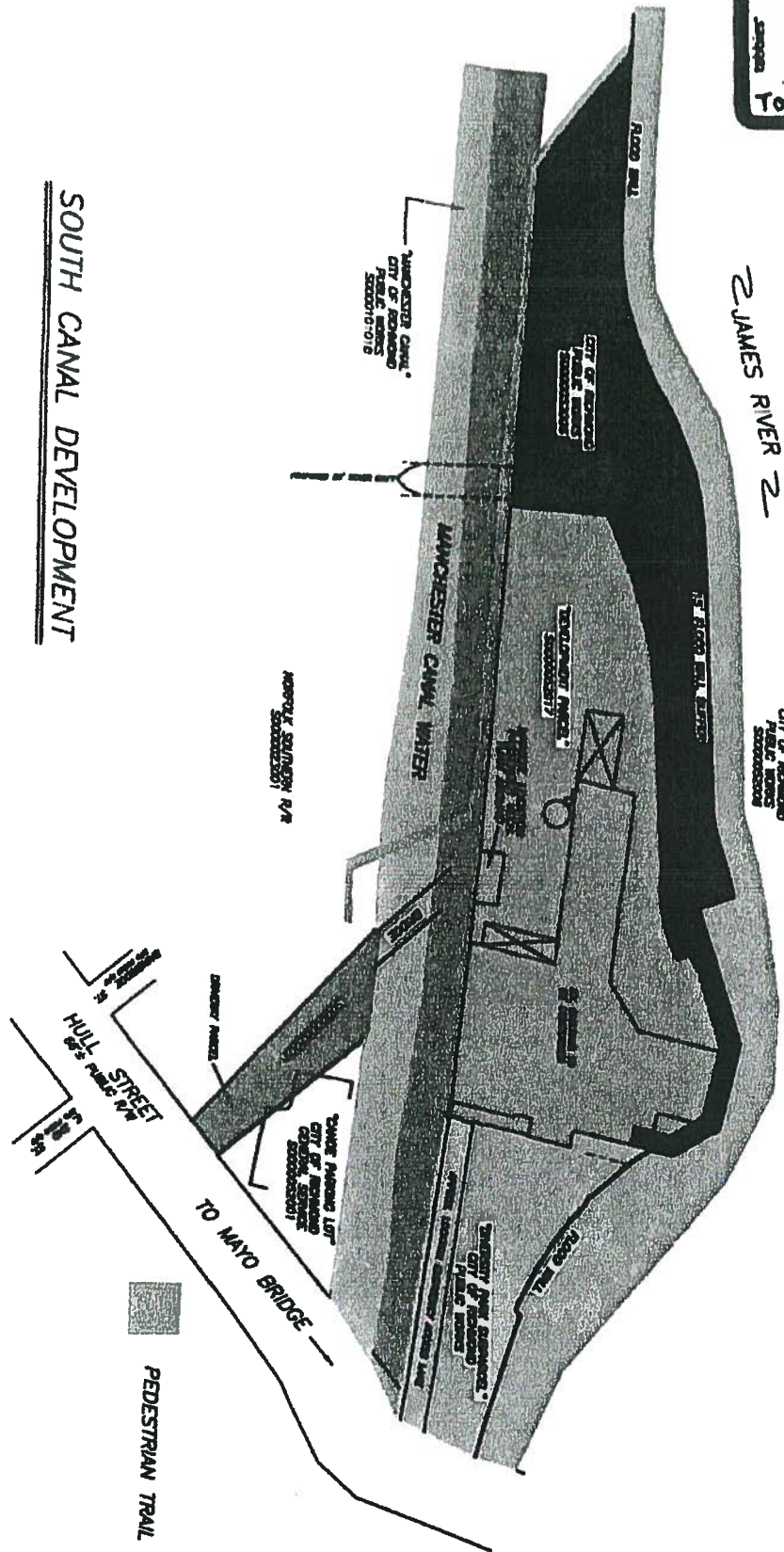

SOUTH CANAL DEVELOPMENT



EXHIBIT ONLY

EXHIBIT C
TO
DEVELOPMENT AND COOPERATION AGREEMENT

Flood Wall Easements

[Attached Hereto]

EXHIBIT C
to
Development Agreement

***THIS INSTRUMENT IS EXEMPT FROM RECORDATION TAX
PURSUANT TO THE PROVISIONS OF VA. CODE § 58.1-811.***

Consideration: \$ n/a

PREPARED BY AND RETURN TO:

Richard W. Gregory, Esquire
Atlas Law, PLLC
7 East Second Street
Richmond, Virginia 23224

Tax Parcel Nos.: S0000052017 and part of S0000052006

**CITY FLOOD WALL BUFFER AND ACCESS AGREEMENT AND DEED OF
EASEMENTS**

This **CITY FLOOD WALL BUFFER AND ACCESS AGREEMENT AND DEED OF EASEMENTS** (“Deed”) made this _____ of _____, 201__, by and between **SOUTH CANAL, LLC**, a Virginia limited liability company (“Grantor”), and **CITY OF RICHMOND, VIRGINIA**, a municipal corporation of the Commonwealth of Virginia (“Grantee”) (each a “Party” and, collectively, the “Parties”), provides as follows:

RECITALS

A. Grantor is the owner of (1) that certain parcel of real property, together with the improvements thereon and the appurtenances thereunto belonging, designated as Tax Map Parcel Nos. S0000052017, which it acquired from Fountainhead Acquisitions, LLC, by deed, dated March 13, 2012, and recorded March 16, 2012, in the Clerk’s Office, Circuit Court, City of Richmond, Virginia (“Clerk’s Office”), as Instrument Number 12-5010, and (2) that certain parcel of real property acquired from the City of Richmond by deed, dated _____, recorded on _____ in the Clerk’s Office as Instrument number _____, such property formerly being a portion of Tax Map Parcel No. S0000052006, which parcels shall be collectively referred to herein as the “Development Parcel” and more particularly described on **Exhibit “A”** attached hereto.

B. Grantee is the owner of (1) that certain parcel of real property, together with the improvements thereon and the appurtenances thereunto belonging, including but not limited to a flood wall (the “Flood Wall”), designated as Tax Map Parcel No. S0000052006 (the “Flood Wall Parcel”) and (2) a portion of that certain parcel of real property, together with any and all improvements located thereon and the appurtenances thereunto belonging, designated as Tax Map Parcel No. S0000101010 (such portion being referred to herein as “Canal Parcel”). The Flood Wall Parcel and Canal Parcel shall be collectively referred to herein as the “City Parcels” as more particularly described on **Exhibit “B”** attached hereto.

C. The Development Parcel is shown as the Development Parcel and City Land Parcel on the survey ("Survey") entitled "COMPILED EXHIBIT showing SOUTH CANAL DEVELOPMENT," Sheet 1 of 1, Job No. 56160036.00, prepared by Balzer and Associates, certified land surveyor, dated June 1, 2016, and attached hereto as Exhibit "C".

D. Grantor intends to develop the Development Parcel (the "Project").

E. Grantee desires to obtain from Grantor and Grantor desires to grant to Grantee an easement (the "Flood Wall Buffer Easement") providing a 15 foot minimum buffer area between the Flood Wall and the Project, which buffer area will provide for the Grantee's access to the Flood Wall for inspection, maintenance, and repairs thereto and is more particularly described on Exhibit D attached hereto ("Flood Wall Buffer Area"). For avoidance of doubt, notwithstanding the foregoing and anything to the contrary on Exhibit D and the Survey, the Flood Wall Buffer Area shall extend a minimum of 15 feet from the southern face of the Flood Wall at all points across the Development Parcel.

F. Grantee desires to obtain from Grantor and Grantor desires to grant to Grantee an easement providing Grantee access over and across the Flood Wall Access Area, as hereinafter defined (the "Flood Wall Access Easement"). (Collectively, the Flood Wall Buffer Easement and the Flood Wall Access Easement shall be referred to herein as the "Flood Wall Easements" and, collectively, the Flood Wall Buffer Area and the Flood Wall Access Area shall be referred to herein as the "Flood Wall Easement Areas.").

G. Grantor and Grantee acknowledge that they have entered into a Development and Cooperation Agreement, dated _____ (the "Development Agreement"), and that this Deed is intended to be executed together with the other documents provided for in the Development Agreement and placed in escrow pursuant to the escrow agreement entered into pursuant to the Development Agreement (the "Escrow Agreement"). This Deed shall not take effect unless and until it is released from escrow pursuant to the terms and conditions of the Development Agreement and Escrow Agreement.

AGREEMENT AND DEED OF EASEMENTS

NOW, THEREFORE, for and in consideration of one dollar (\$1.00), the mutual covenants contained herein, and for other good and valuable consideration, the receipt and sufficiency of which are hereby acknowledged, the parties hereto agree as follows:

1. **Incorporation of Recitals.** The recitals above are incorporated herein by this reference.

2. **Grant of Flood Wall Buffer Easement.** Grantor hereby grants unto Grantee an exclusive perpetual easement across, over, and under the Flood Wall Buffer Area for Grantee's inspection, maintenance and repair of the Flood Wall and any other purpose related thereto. Grantor shall not encroach upon the Flood Wall Buffer Area and shall not in any way construct or place any improvements on, across, over, or under the Flood Wall Buffer Area or otherwise limit Grantee's use of the Flood Wall Buffer Area and maintenance of the Flood Wall, unless Grantee provides Grantor with prior written approval.

3. Grant of Flood Wall Access Easement. Grantor hereby grants unto Grantee a perpetual, non-exclusive easement for pedestrian and vehicular ingress and egress over and across the Flood Wall Access Easement Area, as such area is defined and more particularly described herein, for the purpose of accessing the Flood Wall Flood Wall Buffer Area for any reason including but not limited to inspecting, maintaining, operating and repairing the Flood Wall.

4. Flood Wall Access Easement Area. The Flood Wall Access Easement Area shall be in a location designated by Grantor, which location may be relocated by Grantor from time to time after providing 60 days' notice to Grantee, provided that the Flood Wall Access Easement Area shall at all times (a) provide a continuous length of access from the City's right of way abutting the Development Parcel (currently the Canal Parcel) to the Flood Wall Buffer Area in a continuous width of at least twenty (20) feet and (b) provide a turnaround area with a twenty-five (25) foot turning radius or as necessary to accommodate a full size pickup truck and construction trailer, all as reasonably determined by the Grantee's Director of Public Utilities.

5. Flood Wall Easements. The Flood Wall Easements shall be an easement appurtenant for the benefit of the Flood Wall Parcel and it shall run with the land.

6. No Public Right-of-Way / Public Use. Grantor and Grantee agree that nothing herein shall be construed as creating a right-of-way or easement for public use over or across the Development Parcel.

7. Rights of Others. This conveyance is made subject to all applicable easements, conditions and restrictions of record.

8. Maintenance. The Grantor shall maintain the Flood Wall Easement Areas in good condition, suitable for Grantee's use thereof including but not limited to vehicular travel associated with maintenance of the Flood Wall. Any maintenance or repair required as a result of the Grantee's use of the City Access Easement Area for maintenance, repair or replacement of the City Flood Wall shall be promptly repaired by the Grantee at its sole expense.

9. Destruction and Damage.

(a) In the event that any improvements now or hereafter placed on the Flood Wall Easement Areas by Grantor shall be damaged or destroyed, whether partially or entirely, by the Grantee's negligence, then Grantee shall promptly and within a reasonable time after such damage or destruction, repair, restore or reconstruct or cause to be repaired, restored or reconstructed said damaged or destroyed improvements in such manner that after such repair, restoration or reconstruction, the condition thereof shall be as close as reasonably practical to a condition at least equal to the condition thereof immediately prior to such damage or destruction.

(b) In the event Grantee repairs and replaces damaged or destroyed improvements, it is hereby specifically agreed that all insurance proceeds paid and delivered on account of any damage or destruction, less the costs, if any, of such recovery, shall be paid to Grantee and used by Grantee for the purpose of paying the cost of any and all repairs and reconstruction required to be made by Grantee under the terms of this Deed; otherwise such proceeds shall be paid to Grantor.

(c) Subject to the notification requirement and the cure period provisions herein which shall not be required in the case of an emergency as reasonably determined by the Grantee's designee in his reasonable discretion, if Grantor does not provide the Grantee the Flood Walls Easements granted herein and the Grantee's designee deems it necessary in his reasonable discretion to create the access by modifying improvements upon, or modifying Grantor's or its licensees', tenants', subtenants', agents', and employees' access to, the Development Parcel and the Grantee undertakes said modifications, the Grantee shall not be liable for said modifications and any claims and damages related thereto whether real or alleged, and Grantor hereby indemnifies the Grantee against and releases Grantee from the same and Grantor shall be liable for Grantee's costs related to the modification. This release, indemnity and assumed liability of costs by the Grantor for the benefit of the Grantee shall only be to the extent Grantee modifies the Development Parcel or the access thereto to provide the access guaranteed in the Flood Wall Easement Areas.

10. Hazardous Materials.

(a) Any Hazardous Material to be brought upon or used in or about the Flood Wall Easement Areas by either Party or its employees, contractors, subcontractors, tenants, agents, invitees or licensees shall be used, kept, stored and disposed of in a manner that complies with all federal, state and local laws, rules, regulations, directives, decrees, ordinances, codes, orders, approvals of governmental authorities, licenses or standards, including, without limitation, the federal "Comprehensive Environmental Response, Compensation and Liability Act", the federal "Resource Conservation and Recovery Act" and any state and local law, regulation, or ordinance relating to pollution or protection of human safety, health or the environment (including, without limitation, ambient air, surface water, ground water, land surface or subsurface strata), including, without limitation, laws and regulations relating to emissions, discharges, releases or threatened releases of any Hazardous Material, or otherwise relating to the manufacture, processing, refining, distribution, use, management, treatment, storage, disposal, transport, recycling, reporting or handling of any Hazardous Material (collectively, "Environmental Laws"). In addition, to the extent any environmental permits are required to be obtained by either Party or its employees, contractors, subcontractors, tenants, agents, invitees or licensees in connection such Party's use of the Flood Wall Easement Areas, such Party shall be responsible, at its sole cost and expense, for obtaining such permits and for immediately providing copies of all applications for such permits and copies of all issued permits to the other Party upon request. As used in this Deed, the term "Hazardous Material" means those substances, materials, and wastes listed in the United States Department of Transportation Hazardous Materials Table (49 CFR 172.101) or classified by the Environmental Protection Agency as hazardous substances (40 CFR Part 302), or such substances, materials and wastes which are or become regulated under any applicable local, state or federal law, including, without limitation, any material, waste or substance which is (1) petroleum, (2) asbestos, (3) polychlorinated biphenyls, (4) designated as a hazardous substance pursuant to the federal "Clean Water Act", the federal "Resource Conservation and Recovery Act", or the federal "Comprehensive Environmental Response, Compensation and Liability Act", (5) excreta or other animal waste, or (6) lead.

(b) Neither Party nor its employees, contractors, subcontractors, tenants, agents, invitees or licensees shall discharge, leak or emit, or knowingly permit to be

discharged, leaked or emitted, any Hazardous Materials the atmosphere, ground, sewer system or any body of water.

(c) The Parties shall maintain good spill prevention practices as recommended by governmental agencies having jurisdiction over the Flood Wall Easement Areas and shall comply with all applicable regulations and containment practices. Any and all releases, spills, discharges, emissions, etc. occurring on the Flood Wall Easement Area shall be documented by the offending Party and reported to the other Party and the appropriate authority under applicable law within twenty-four (24) hours of the occurrence thereof. Immediate steps shall be taken by the offending Party in the event of an uncontained release to minimize the duration, amount and extent of any discharge to the environment. The Parties shall require all contractors and subcontractors of the such Party operating on the Flood Wall Easement Areas to maintain and make immediately available to the other Party, any and all material safety data sheets required by law and pertaining to materials or substances discovered, encountered, brought upon, stored, used or consumed in any construction within the Flood Wall Buffer Areas, regardless of their source.

(d) If any Hazardous Materials are released into the environment as a result of the actions (or inactions) of either Party or its employees, contractors, subcontractors, tenants, agents, invitees or licensees, the offending Party shall be responsible as between the Parties, at its sole cost and expense, for completing any and all remediation activities that may be required to be undertaken in compliance with any applicable laws or any directive from any governmental entity having jurisdiction over the Flood Wall Easement Areas. Any required remediation activities shall be completed by the offending Party in accordance with all applicable laws. The obligations under this subsection (d) shall survive the expiration or earlier termination of this Deed.

11. Mechanic's and Other Liens. Grantee shall not cause or permit any mechanics lien to remain against the Development Parcel and any improvements thereon.

12. Further Assurances. The Parties agree to grant such further assurances and to execute such instruments as may be reasonably necessary to confirm the easements granted herein.

13. Default. If either Party shall fail to comply with any term, provision or covenant of this Deed, and shall not cure such failure within thirty (30) days after written notice thereof by the non-defaulting Party, then the Party failing to comply with any term, provision or covenant of this Deed shall be in default of this Deed provided, however, that if said term, provision or covenant to be performed is of such nature that same cannot reasonably be performed within such thirty (30) day period, such failure shall not constitute a default if the defaulting party commences such performance to cure said default within said thirty (30) day period and thereafter diligently undertakes to complete the same as reasonably determined by the non-defaulting party.

14. Remedies. If Grantee defaults in its responsibilities set out herein, Grantor shall have the right to cure the default, which it is hereby agreed shall be at the Grantee's expense, and Grantor may pursue all available remedies against Grantee at law and equity for any costs and damages incurred. If Grantee materially defaults in its responsibilities set out herein, Grantor may also terminate this Deed. If Grantor defaults in its responsibilities set out herein Grantee shall have

the right to cure the default, which it is hereby agreed shall be at the Grantor's expense, and Grantee may pursue all available remedies against Grantee at law and equity for any costs and damages incurred, including reasonable attorneys' fees and Grantee may also terminate this Deed.

15. Applicable Law. This Deed shall be given effect and construed by application of the laws of the Commonwealth of Virginia.

16. Subject to Appropriation. Any payments and other performances by Grantee under this Deed are subject to annual or periodic appropriations by the City Council of the City of Richmond, Virginia. It is understood and agreed between Grantor and Grantee that Grantee shall be bound hereunder only to the extent of the funds available or which may hereafter become available for the purposes of performing under this Deed. Under no circumstances shall Grantee's total liability under this Deed exceed the total amount of funds appropriated by the City Council of the City of Richmond, Virginia for the Grantee's performance of this Deed.

17. Signature Authority. Except where specifically provided herein, the Chief Administrative Officer for the City of Richmond or the designee thereof may provide any authorization, approvals, and notices contemplated herein on behalf of the City.

18. Miscellaneous. The parties hereto agree that this Deed shall be recorded in the land records of the Circuit Court for the City of Richmond, Virginia. This Deed in its entirety shall inure to the benefit of and shall be binding upon the parties hereto and their respective successors and assigns. Any amendments hereto shall be in writing and shall be signed by all parties hereto. This Deed, together with the Development Agreement and transaction documents referred to therein, represents the entire agreement between the parties with respect to the subject matter hereof. The covenants and agreements contained in this Deed shall run with the land and shall be binding upon any and all succeeding land owners, their personal representatives, estates, heirs, devisees, assigns or successors in interest or any other parties having or taking an interest in or to the property covered by this Deed. No party hereto shall be deemed to have waived the exercise of any right which it holds hereunder unless such waiver is made expressly and in writing. No determination by any court, governmental or administrative body or agency or otherwise that any provision of this Deed or any amendment hereof is invalid or unenforceable in any instance shall affect the validity or enforceability of (a) any other provision hereof, or (b) such provision in any circumstance not controlled by such determination. Each such provision shall remain valid and enforceable to the fullest extent allowed by, and shall be construed wherever possible as being consistent with applicable law.

[SIGNATURES APPEAR ON THE FOLLOWING PAGES]

SIGNATURE PAGE TO CITY FLOOD WALL BUFFER AGREEMENT AND DEED OF EASEMENTS

Witness the following signatures.

GRANTOR:

SOUTH CANAL, LLC,
A Virginia limited liability company

By: _____
Name: Richard W. Gregory
Title: Authorized Representative

ACKNOWLEDGMENT

COMMONWEALTH OF VIRGINIA)	
)	TO WIT:
CITY OF RICHMOND:)	

I HEREBY CERTIFY, that on this ____ day of _____, 2016, before me, the subscriber, a Notary Public of the State aforesaid, personally appeared **Richard W. Gregory**, known to me, or satisfactorily proven to be, the person whose name is subscribed to the within instrument, and who acknowledged to be the Authorized Representative of **SOUTH CANAL, LLC**, a Virginia limited liability company, and acknowledged that execution of the foregoing instrument for the purposes therein contained and acknowledged the same to be the lawful act and deed of the aforesaid company.

AS WITNESS my hand and Notarial Seal the day and year first above written.

NOTARY PUBLIC

My Commission Expires: _____

Registration No.: _____

**SIGNATURE PAGE TO CITY FLOOD WALL BUFFER AND ACCESS AGREEMENT AND
DEED OF EASEMENTS**

GRANTEE:

CITY OF RICHMOND, VIRGINIA,
a municipal corporation of the Commonwealth of Virginia

By: _____
Selena Cuffee-Glenn

Its: Chief Administrative Officer

ACKNOWLEDGMENT

COMMONWEALTH OF VIRGINIA)	TO WIT:
)	
CITY OF RICHMOND:)	

I HEREBY CERTIFY, that on this ____ day of _____, 2016, before me, the subscriber, a Notary Public of the State aforesaid, personally appeared SELENA CUFFEE-GLENN, known to me, or satisfactorily proven to be, the person whose name is subscribed to the within instrument, and who acknowledged to be the Chief Administrative Officer of the City of Richmond, Virginia, a municipal corporation of the Commonwealth of Virginia, and acknowledged that execution of the foregoing instrument for the purposes therein contained and acknowledged the same to be the lawful act and deed of the aforesaid corporation.

AS WITNESS my hand and Notarial Seal the day and year first above written.

NOTARY PUBLIC

My Commission Expires:_____

Registration No.:_____

APPROVED AS TO FORM:



Assistant City Attorney



Exhibit A
to
City Flood Wall Buffer and Access Agreement and Deed of Easements

Legal Description of Development Parcel

Portion 1 of the Development Parcel (Tax Parcel ID S0000052017):

All that land lying and being in the City of Richmond and identified as Development Parcel (Parcel C), containing 1.715 acres, more or less, all as shown on that certain survey entitled "COMPILED EXHIBIT showing SOUTH CANAL DEVELOPMENT," Sheet 1 of 1, Job No. 56160036.00, prepared by Balzer and Associates, and dated June 1, 2016, a copy of which is attached hereto and made a part hereof, and, with reference to such survey, is more particularly described as follows:

COMMENCING at a point at the intersection of the North line of Hull Street, U.S. Route 360, and the East line of Brander Street; thence along a tie line N52°59'35"W, 506.00 feet to a point, said point being the POINT OF BEGINNING; thence N03°46'04"E, 79.36 feet to a point; thence along a curve to the left having a radius of 385.25 feet, an arc length of 14.12 feet, and a chord of N67°48'36"E, 14.12 feet to a point; thence N66°38'31"E, 18.92 feet to a point; thence along a curve to the right having a radius of 334.75 feet, an arc length of 115.67 feet, and a chord of N76°32'30"E, 115.10 feet to a point; thence N86°26'28"E, 156.34 feet to a point; thence along a curve to the left having a radius of 105.25 feet, an arc length of 51.09 feet, and a chord N72°32'09"E, 50.59 feet to a point; thence N31°22'09"W, 10.25 feet to a point; thence N58°37'51"E, 83.63 feet to a point; thence S77°32'39"E, 68.01 feet to a point; thence S12°28'53"W, 2.68 feet to a point; thence S31°41'03"E, 40.44 feet to a point; thence S12°18'33"W, 81.14 feet to a point; thence S77°41'27"E, 12.00 feet; thence S12°18'33"W, 103.00 feet to a point; thence N71°10'55"W, 11.83 feet to a point; thence N84°33'54"W, 125.60 feet; thence N86°13'56"W, 342.00 feet to the POINT AND PLACE OF BEGINNING.

Portion 2 of the Development Parcel (formerly a portion of Tax Parcel ID S0000052006):

All that land lying and being in the City of Richmond and identified as City Land (Sub-Parcel A-2), containing 1.096 acres, more or less, all as shown on that certain survey entitled "COMPILED EXHIBIT showing SOUTH CANAL DEVELOPMENT," Sheet 1 of 1, Job No. 56160036.00, prepared by Balzer and Associates, and dated June 1, 2016, a copy of which is attached hereto and made a part hereof, and, with reference to such survey, is more particularly described as follows:

COMMENCING at a point at the intersection of the North line of Hull Street, U.S. Route 360, and the East line of Brander Street; thence along a tie line N52°59'35"W, 506.00 feet to a point, said point being the POINT OF BEGINNING; thence N86°13'56"W, 238.82 feet to a point; thence along a curve to the right having a radius of 65.94 feet, an arc length of 35.96 feet, and a chord of N74°59'10"W, 35.51 feet to a point; thence N53°20'46"W, 77.04 feet to a point; thence N51°58'33"W, 31.19 feet to a point; thence along a curve to the right having a radius of 165.00 feet, an arc length of 25.29 feet, and a chord of S88°41'53"E, 25.26 feet to a point; thence S86°37'26"E, 105.29 feet to a point; thence along a curve to the left having a radius of 235.00 feet, an arc length of 138.67 feet, and a chord of N76°28'17"E, 136.67

feet to a point; thence N59°34'00"E, 6.99 feet to a point; thence along a curve to the right with a radius of 265.00 feet, an arc length of 126.30 feet, and a chord of N73°13'14"E, 125.11 feet; thence N86°52'28"E, 203.81 feet to a point; thence along a curve to the left having a radius of 85.00 feet, an arc length of 23.76 feet, and a chord of N78°52'03"E, 23.68 feet to a point; thence N70°51'39"E, 46.85 feet to a point, thence S19°22'57"E, 28.88 feet to a point; thence N71°15'03"E, 116.67 feet to a point; thence S77°00'33"E, 66.53 feet to a point; thence S30°56'37"E, 39.06 feet to a point; thence S12°18'33"W, 4.78 feet to a point; thence N31°41'03"W, 40.44 feet to a point; thence N12°28'53"E, 2.68 feet to a point; thence N77°32'39"W, 68.01 feet to a point; thence S58°37'51"W, 83.63 feet to a point; thence S31°22'09"E, 10.25 feet to a point; thence along a curve to the right having a radius of 105.25, an arc length of 51.09 feet, and a chord of S72°32'09"W, 50.59 feet to a point; thence S86°26'28"W, 156.34 feet to a point; thence along a curve to the Left having a radius of 334.75 feet, an arc length of 115.67 feet, and a chord of S76°32'30"W, 115.10 feet to a point; thence S66°38'31"W, 18.92 feet, thence along a curve to the right having a radius of 385.25 feet, an arc length of 14.12 feet, and a chord of S67°48'36"W, 14.12 feet to a point; thence S03°46'04"W, 79.36 feet to the POINT AND PLACE OF BEGINNING.

Portion 2 being the same property conveyed to South Canal, LLC, from the City of Richmond pursuant to the Development Agreement, by deed dated _____, 20____, and recorded immediately preceding the recordation of this DEED in deed book _____, page _____, in the Circuit Court of the City of Richmond.

Exhibit B
to
City Flood Wall Buffer and Access Agreement and Deed of Easements

Legal Description of City Parcels

Tax Map Number S0000052006 and part of S0000101010

Portion 1 of the City Parcels (being a portion of the Flood Wall Parcel)

ALL that certain tract of land with all improvements thereon and appurtenances thereto belonging lying on the South bank of the James River immediately West of the abutment of the Mayo Bridge and Hull Street in the City of Richmond, Virginia all as more particularly shown as Parcel "A" and Parcel "B" on a "PLAT OF STANDARD PAPER MFG. CO. BUILDING AND PARCEL OF LAND SAID BUILDING SITUATED THEREON, RICHMOND, VIRGINIA" dated February 13, 1979 drawn by William J. Schmidt & Assoc., Engineers & Surveyors, a copy of which plat is attached hereto and incorporated by reference.

BEING the same real estate conveyed to the City of Richmond from Ross Investment Corporation by that certain Order Directing the Recordation of the Vesting of Title, dated September 29, 1987, recorded on October 6, 1987, in Deed Book 143 at page 1265, in the Clerk's Office, and the same real estate conveyed to Ross Investment Corporation from Virginia Electric and Power Company with special warranty of title by the certain Agreement and Deed dated February 12, 1979, recorded on February 13, 1979, in Deed Book 555 at page 195, in the Clerk's Office. PARCEL "A" further BEING a part of the same real estate conveyed to Virginia Railway and Power Company by deed from Hill Carter, et als, Special Masters, dated June 29, 1909 and recorded July 1, 1909 in deed book 32, page 271 in the Circuit Court of the City of Richmond, Virginia, Division Two: the Virginia Railroad and Power Company having duly changed its name to the Virginia Electric and Power Company. Parcel "B" further being the same real estate conveyed to Standard Paper Manufacturing Company by deed from Manchester Board and Paper Company, Incorporated, dated November 17, 1947, recorded December 5, 1947 in deed book 115, page 312 in the aforesaid Clerk's Office.

Portion 2 of the City Parcels (being a portion of the Flood Wall Parcel)

BEGINNING at a point on the common division line between property formerly owned by Manchester Board and Paper Co., Inc. and property formerly owned by Ross Investment Corp. on the South edge of the James River, thence S12°50'01"W a distance of 62+ feet to a point; thence N31°09'35"W a distance of 43.23 feet to a point; thence N13°00'21"E a distance of 2.68 feet to a point; thence N76°59'39"W a distance of 67.23 feet to a point; thence S59°09'19"W a distance of 81.98 feet to a point; thence S30°50'41"E (radial) a distance of 10.25 feet to a point; thence on a curve deflecting to the Right having a radius of 105.25 feet and having a length of 51.09

feet to a point; thence S86°57'56"W a distance of 156.34 feet to a point; thence on a curve deflecting to the Right having a radius of 334.75 feet and a length of 115.68 feet to a point; thence S67°09'59"W a distance of 18.92 feet to a point; thence on a curve deflecting to the right having a radius of 385.25 feet and having a length of 14.17 feet to a point on the common division line between property formerly owned by Manchester Board and Paper Co., Inc. and property formerly owned by ReeTree Partnership; thence N4°17'32"E a distance of 70.66 feet to a rod; thence N4°17'32"E a distance of 37+ feet to the South edge of the James River; thence Eastwardly along the South edge of the James River a distance of 512+ feet to the point of beginning. Said point of beginning being the 341+ feet Westwardly along the South edge of the James River from the West line of the Mayo's Bridge, all as shown shaded on Parcel 2 of the Department of Public Works Drawing No. 0-21676, Sheet 1, attached hereto as "Schedule A", and containing 34,513+ square feet (0.79+ acres).

BEING a the same real estate conveyed in fee simple to the City of Richmond with Special Warranty of Title from Manchester Board and Paper, Co. by that by that certain Deed, Deed of Easement, and Deed of Partial Release, dated January 11, 1988, recorded February 11, 1988, in Deed Book 156 at page 897, in the Clerk's Office.

Portion 3 of the City Parcels (being a portion of the Flood Wall Parcel)

ALL that certain piece or parcel of land, together with the buildings and improvements thereon and appurtenances thereto belonging, lying and being in the City of Richmond, Virginia, on the South side of the James River, which is known and designated as 1.25 + or – acres parcel of land, with improvements thereon, being the Western-most part of property formerly owned by Manchester Board and Paper, Co., Inc., as designated on a Physical Survey made by Austin Brockenbrough and Associates, Consulting Engineers, in the City of Richmond, Virginia, dated November 19, 1979, which is attached hereto and to which reference is made hereby for a more particular description of the property.

BEING that same real estate acquired by the City of Richmond from ReeTree Partnership, etc., et. al, and any other owners thereof, by that certain Order Directing the Recordation of the Vesting of Title, dated September 29, 1987, recorded on October 6, 1987, in Deed Book 143 at page 1271, in the Clerk's Office, and BEING the same real estate conveyed to Ree-Tree Partnership with general warranty of title from Manchester Board and Paper Co., Inc., by that certain Deed and Bargain of Sale, dated December 10, 1979, recorded December 21, 1979, in Deed Book 560, at page 1189, in the Clerk's Office.

Portion 4 of the City Parcels (being the Canal Parcel and a portion of the Flood Wall Parcel)

ALL that certain piece or parcel of land lying and being in the City of Richmond, Virginia BEING that same property conveyed to the City of Richmond from Virginia Electric and Power Company ("VEPCO") by that certain Special Warranty Deed, dated June 9, 1989, recorded June 16, 1989, in Deed Book 205, at page 212, in the Clerk's

Office, and BEING identified as Parcel 4, containing 2.43 acres, more or less, all as shown by shading on that certain Plat of Survey entitled "Proposed Dedication Of Property West Of Mayo's Bridge, Between The James River And Southern Railway R/W, For Floodwall Purposes (Southside Protection)," Sheet 2 of 3, Drawing No. 0-21890, Prepared by the Department of Public Works, Richmond, Virginia, and dated August 1, 1988, a copy of which is attached hereto and made a part hereof and, with reference to such Plat is more particularly described as follows:

BEGINNING at a point in the property line dividing property formerly owned by the VEPCO and property now or formerly owned by the City of Richmond, Virginia, which point is N. 82° 10' 02" W. 20.98 feet from a property corner; thence S. 50° 49' 08" W. 93.62 feet along the westerly line of Hull Street to a point; thence N. 83° 44' 22" W. 203.48 feet along the property line dividing property formerly owned by VEPCO and property now or formerly owned by said City of Richmond to a point; thence N. 39° 52' 52" W. 4.30 feet along the property line dividing property formerly owned by VEPCO and property formerly owned by Manchester Board and Paper Company, Inc. to a point; thence N. 84° 44' 21" W. 97.75 feet along said property line to a point; thence northwestwardly 900 feet, more or less, along the property line dividing property formerly owned by VEPCO and property formerly owned by Southern Railway Company to a point in the property line dividing property and property formerly owned by Southern Railway Company; thence northeastwardly 125 feet, more or less, along said property line to a point; thence northeastwardly 115 feet, more or less, along said property line to a point; thence northeastwardly 105 feet, more or less, along said property line to a point in the southerly line of the James River; thence eastwardly 95 feet, more or less, along the southerly line of the James River to a point; thence S. 40° 54' 32" W. 68 feet, more or less, along the property line dividing property formerly owned by VEPCO and the property now or formerly owned by the City of Richmond to a point; thence S. 40° 54' 32" W. 155.60 feet along said property line to a point, marked by an iron pin; thence S. 85° 42' 28" E. 352.00 feet along said property line to a point, marked by a spike; thence S. 85° 42' 28" E. 342.00 feet along the property line dividing property formerly owned by VEPCO and property formerly owned by Manchester Board and Paper Company, Inc. to a point; thence S. 84° 02' 26" E. 125.60 feet along said property line to a point; thence S. 70° 39' 27" E. 11.83 feet along said property line to a point; thence S. 82° 10' 02" E. 239.87 feet along the property line dividing property formerly owned by VEPCO and property now or formerly owned by the City of Richmond to the point of beginning.

LESS AND EXCEPT all such property conveyed to South Canal, LLC, from the City of Richmond pursuant to the Development Agreement, by deed dated _____, 20____, and recorded immediately preceding the recordation of this DEED in deed book ____, page ____, in the Circuit Court of the City of Richmond, such property being more particularly described on Exhibit A to this DEED as Portion 2 of the Development Parcel.

PLAT OF SURVEY

JAMES RIVER

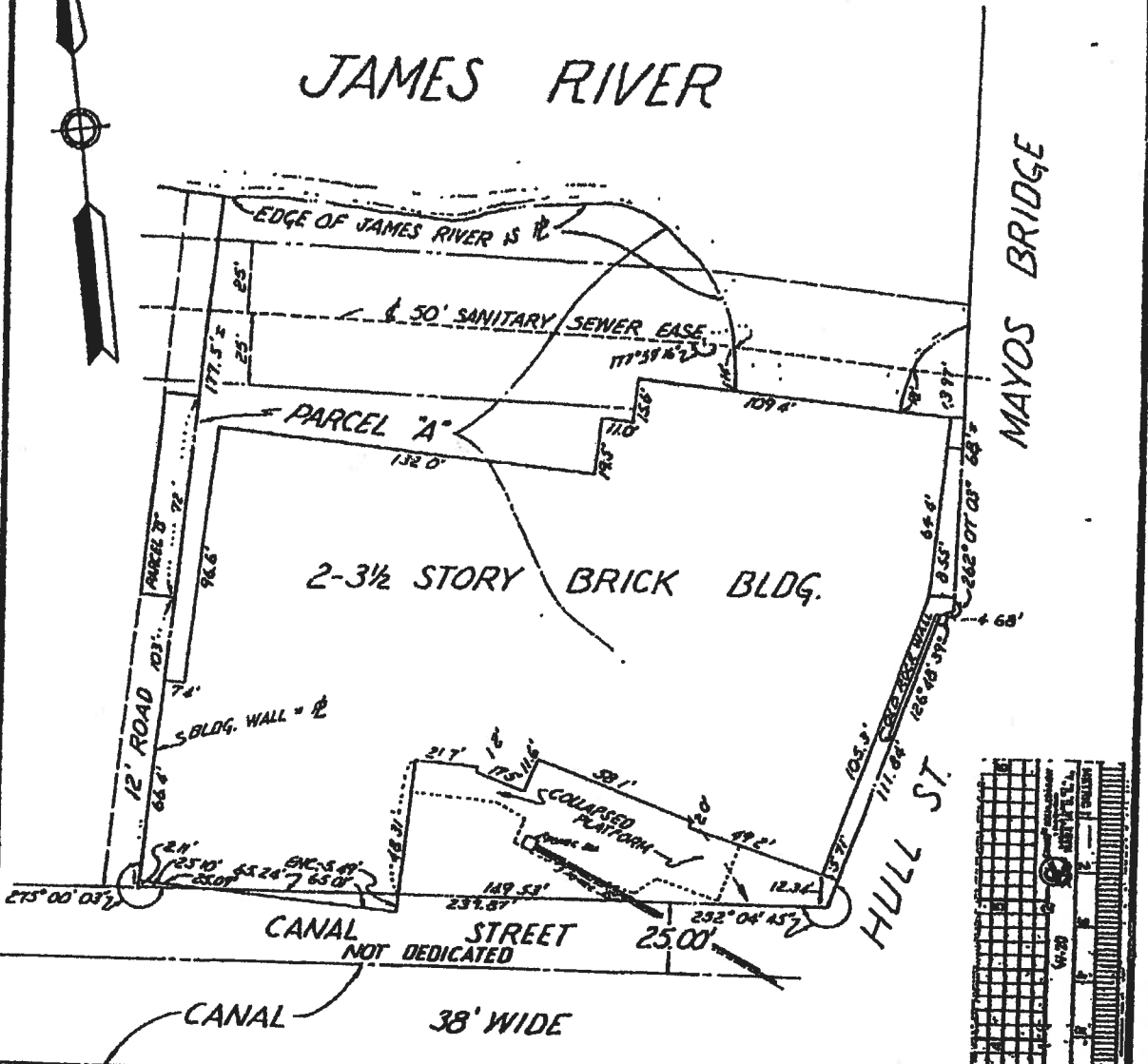

AREA OF PARCEL 'A' - 1.34 ± ACS.
AREA OF PARCEL 'B' - 0.02 ± AC.

PLAT OF STANDARD PAPER MFG. CO.
BUILDING AND PARCEL OF
LAND SAID BUILDING SITUATED
THEREON
RICHMOND, VIRGINIA

SCALE: 1" = 50'
DATE: FEB. 13, 1979

WILLIAM J. SCHMIDT & ASSOC.
ENGINEERS & SURVEYORS
4916 W. MARSHALL ST. - RICHMOND, VA.

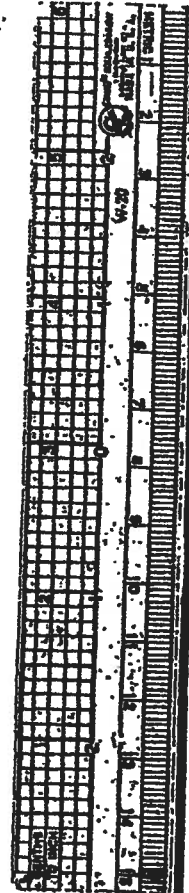

78000

1. Name of the project	2. Date of issue	3. Name of the engineer	4. Name of the client
5. Name of the contractor	6. Name of the architect	7. Name of the surveyor	8. Name of the drafter
9. Name of the checker	10. Name of the approver	11. Name of the reviewer	12. Name of the final approver

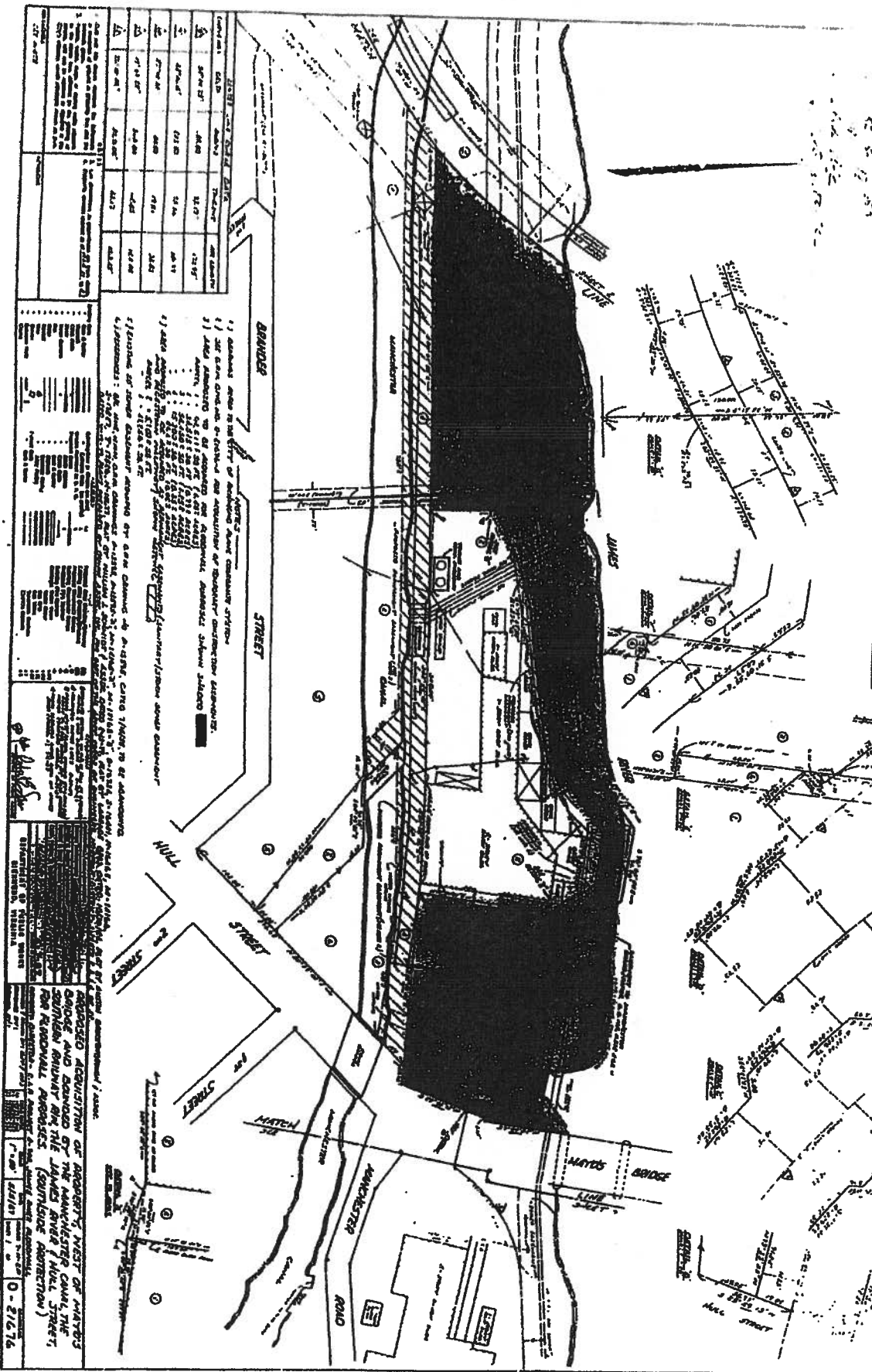

1) Details and notes to be left of building and construction items
 2) For each grade or level of building or structure, construction elevations
 3) All elevations to be given in feet and inches, unless otherwise specified
 4) All elevations to be given in feet and inches, unless otherwise specified
 5) All elevations to be given in feet and inches, unless otherwise specified
 6) All elevations to be given in feet and inches, unless otherwise specified
 7) All elevations to be given in feet and inches, unless otherwise specified
 8) All elevations to be given in feet and inches, unless otherwise specified
 9) All elevations to be given in feet and inches, unless otherwise specified
 10) All elevations to be given in feet and inches, unless otherwise specified

APPROVED ACQUISITION OF PROPERTY WEST OF MAYNARD
 BRIDGE AND DEDICATED BY THE MASSACHUSETTS CANAL THE
 SOUTH BRIDGE BY THE JAMES AVENUE HIGH STREET
 FOR ROADWAY PURPOSES (SOUTHWARD DIRECTION)

DPW avg. no. 0-24676

156-997

PB 38-82

35-92

NOW OR FORMERLY
WEPKO

RECORDERS
OF THE CITY OF RICHMOND AND DRAWING # 1-1280
D DATED 4-28-68
D PART OF THE CHANGE 1985 DATED 07-10-85

PLAT SHOWING A 1.251 ACRE PARCEL OF
LAND WITH IMPROVEMENTS THEREON
BEING THE WESTERN MOST PART OF PROPERTY
OWNED BY MANCHESTER BOARD OF PROPERTY
COMPANY, LOCATED IN THE CITY
OF RICHMOND, VIRGINIA

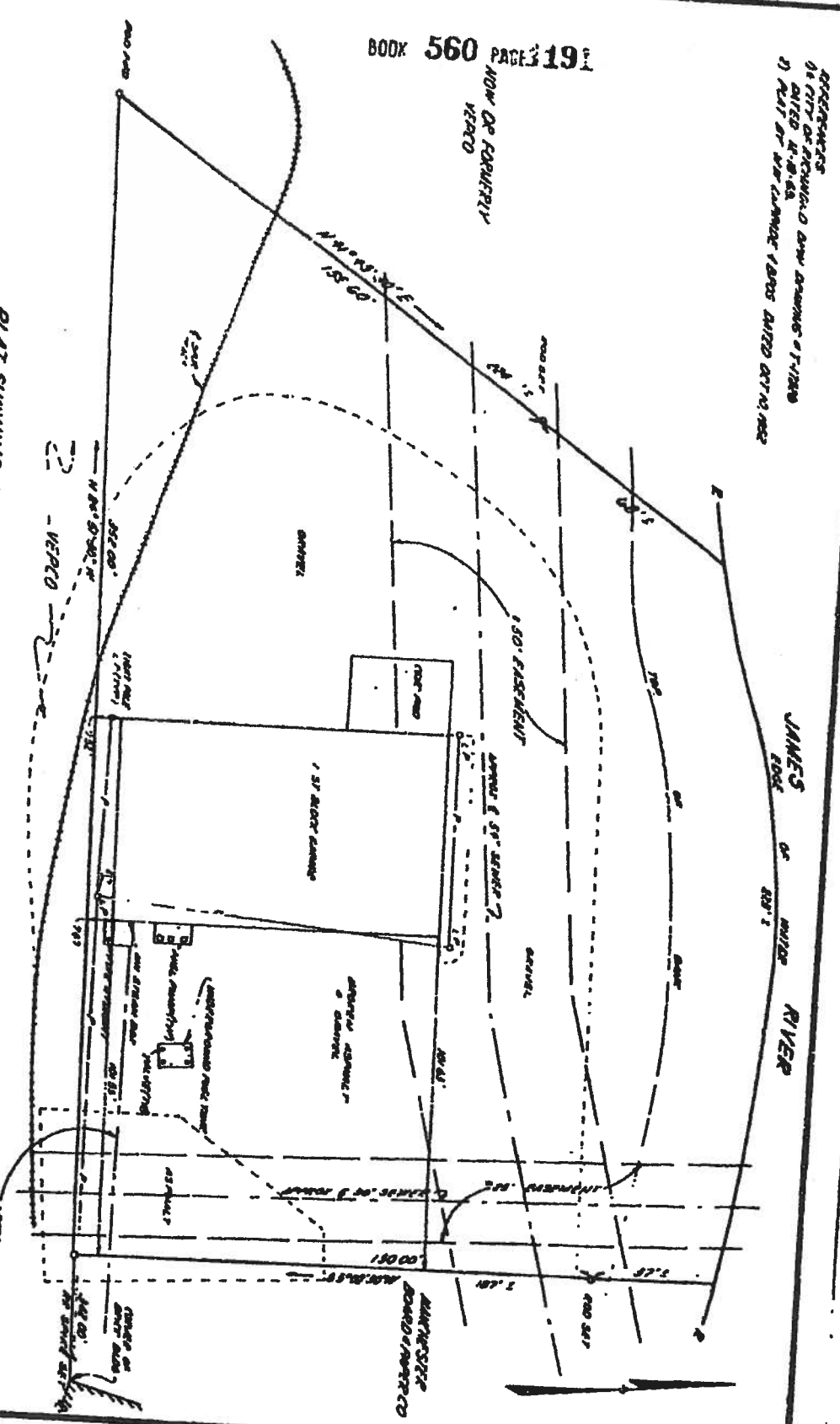

JAMES RIVER



**AUSTIN BROCK BROUGH
AND ASSOCIATES**
(CONSULTING ENGINEERS)

IN THE CITY OF RICHMOND

DATE OF PLAT	04-28-68
DATE OF RECORD	07-10-85
BOOK	560
PAGE	191
BY	C. 2718

1.251 ACRES
1.251 ACRES
1.251 ACRES
1.251 ACRES

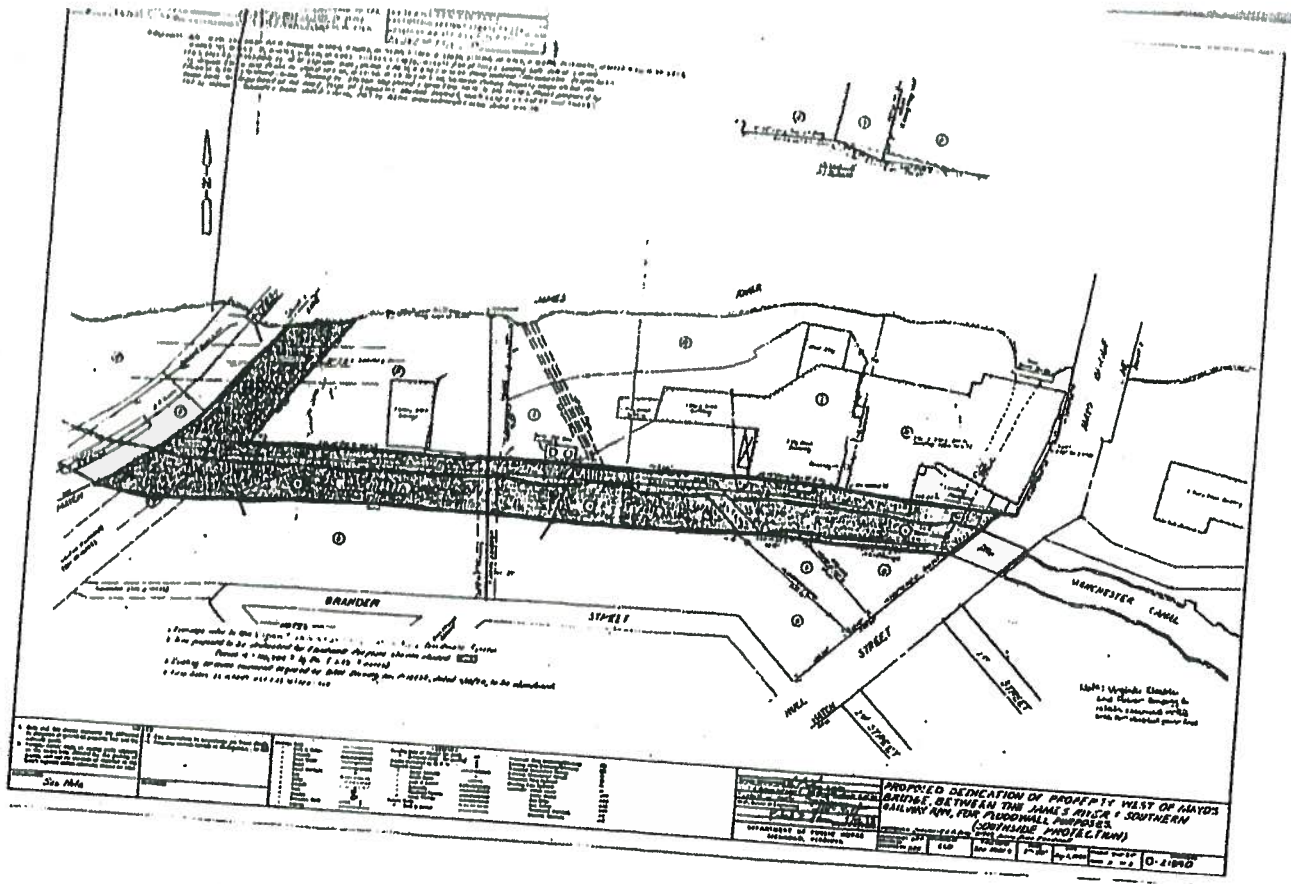

D.P.W. DWG. NO. O-21890

Exhibit C
to
City Flood Wall Buffer and Access Agreement and Deed of Easements

SURVEY

[See following page]

Exhibit D
to
City Flood Wall Buffer and Access Agreement and Deed of Easements

Legal Description of Flood Wall Buffer Area

All that land lying and being in the City of Richmond immediately south of the City flood wall and identified as Proposed 15' Flood Wall Buffer Easement (Sub-Parcel A-3), containing 0.317 acre, more or less, all as shown on that certain survey entitled "COMPILED EXHIBIT showing SOUTH CANAL DEVELOPMENT," Sheet 1 of 1, Job No. 56160036.00, prepared by Balzer and Associates, and dated June 1, 2016, a copy of which is attached hereto and made a part hereof, and, with reference to such survey, is more particularly described as follows:

COMMENCING AT A POINT AT THE INTERSECTION OF THE NORTH LINE OF HULL STREET, U.S. ROUTE 360, AND THE EAST LINE OF BRANDER STREET; THENCE ALONG A TIE LINE N52°59'35"W, 506.00 FEET TO A POINT; THENCE N86°13'56"W, 238.82; THENCE ALONG A CURVE TO THE RIGHT HAVING A RADIUS OF 65.94 FEET, AN ARC LENGTH OF 35.96 FEET, AND A CHORD OF N74°59'10"W, 35.51 FEET TO A POINT; THENCE N53°20'46"W, 77.04 FEET TO A POINT; THENCE N51°58'33"W, 31.19 FEET TO A POINT, SAID POINT BEING THE POINT OF BEGINNING; THENCE ALONG A CURVE TO THE RIGHT HAVING A RADIUS OF 165.00 FEET, AN ARC LENGTH OF 25.29 FEET, AND A CHORD OF S88°41'53"E, 25.26 FEET TO A POINT; THENCE S86°37'26"E, 105.29 FEET TO A POINT; THENCE ALONG A CURVE TO THE LEFT HAVING A RADIUS OF 235.00 FEET, AN ARC LENGTH OF 138.67 FEET, AND A CHORD OF N76°28'17"E, 136.67 FEET TO A POINT; THENCE N59°34'00"E, 6.99 FEET TO A POINT; THENCE ALONG A CURVE TO THE RIGHT WITH A RADIUS OF 265.00 FEET, AN ARC LENGTH OF 126.30 FEET, AND A CHORD OF N73°13'14"E, 125.11 FEET; THENCE N86°52'28"E, 203.81 FEET TO A POINT; THENCE ALONG A CURVE TO THE LEFT HAVING A RADIUS OF 85.00 FEET, AN ARC LENGTH OF 23.76 FEET, AND A CHORD OF N78°52'03"E, 23.68 FEET TO A POINT; THENCE N70°51'39"E, 46.85 FEET TO A POINT; THENCE S19°22'57"E, 28.88 FEET TO A POINT; THENCE N71°15'03"E, 116.67 FEET TO A POINT; THENCE S77°00'33"E, 66.53 FEET TO A POINT; THENCE S30°56'37"E, 39.06 FEET TO A POINT; THENCE S12°18'33"W, 4.78 FEET TO A POINT; THENCE S12°18'33"W, 17.11 FEET TO A POINT; THENCE N30°56'37"W, 48.62 FEET TO A POINT; THENCE N77°00'33"W, 55.89 FEET TO A POINT; THENCE S71°15'03"W, 64.74 FEET TO A POINT; THENCE S71°15'03"W, 62.50 FEET TO A POINT; THENCE N19°22'57"W, 28.78 FEET TO A POINT; THENCE S70°51'39"W, 31.92 FEET TO A POINT; THENCE ALONG A CURVE TO THE RIGHT HAVING A RADIUS OF 100.00 FEET, AN ARC LENGTH OF 27.95 FEET, AND A CHORD OF S78°52'03"W, 27.86 FEET TO A POINT; THENCE S86°52'28"W, 203.81 FEET TO A POINT; THENCE ALONG A CURVE TO THE LEFT HAVING A RADIUS OF 250.00 FEET, AN ARC LENGTH OF 119.15 FEET, AND A CHORD OF S73°13'14"W, 118.03 FEET TO A POINT; THENCE S59°34'00"W, 6.99 FEET TO A POINT; THENCE ALONG A CURVE TO THE RIGHT HAVING A RADIUS OF 250.00 FEET, AN ARC LENGTH OF 147.52 FEET, AND A CHORD OF S76°28'17"W, 145.39 FEET TO A POINT; THENCE N86°37'26"W, 105.25 FEET TO A POINT; THENCE ALONG A CURVE TO THE LEFT HAVING A RADIUS OF 150.00 FEET, AN ARC

LENGTH OF 6.26 FEET, AND A CHORD OF N88°07'16"W, 6.26 FEET TO A POINT; THENCE
N51°58'33"W, 23.05 FEET TO THE POINT OF BEGINNING.

EXHIBIT D
TO
DEVELOPMENT AND COOPERATION AGREEMENT

Driveway Deed

[Attached Hereto]

EXHIBIT D
to
Development Agreement

PREPARED BY AND RETURN TO:

Richard W. Gregory, Esquire
Atlas Law, PLLC
7 East Second Street
Richmond, Virginia 23224
GPIN Numbers: S0000052009

***THIS INSTRUMENT IS EXEMPT FROM RECORDATION TAX
PURSUANT TO THE PROVISIONS OF VA. CODE § 58.1-811(A)(3).***

Consideration: \$ _____
Tax Assessment: \$ _____

SPECIAL WARRANTY DEED

THIS SPECIAL WARRANTY DEED is made this ____ day of _____,
20__, by SOUTH CANAL, LLC, a Virginia limited liability ("Grantor"), and the CITY
OF RICHMOND, VIRGINIA, a municipal corporation of the Commonwealth of Virginia
("Grantee").

WITNESSETH:

In consideration of the sum of Ten Dollars (\$10.00) cash in hand paid by
Grantee to Grantor, and other good and valuable consideration, the receipt and
sufficiency of which are hereby acknowledged, Grantor does hereby grant and
convey with SPECIAL WARRANTY, unto the Grantee all that certain real property
located in the City of Richmond, Virginia, known as Tax Map Parcel S0000052009,
Richmond, Virginia, which property is more particularly described as follows:

See Exhibit "A" Attached Hereto

This conveyance is made subject to all applicable easements, conditions and
restrictions of record.

[Signatures appear on the following page]

IN WITNESS WHEREOF, the Grantor has caused this Deed to be executed by its duly authorized representative as of _____, __, 20__ :

GRANTOR:

SOUTH CANAL, LLC,
A Virginia limited liability company

By: _____
Richard W. Gregory,
Authorized Representative

ACKNOWLEDGMENT

COMMONWEALTH OF VIRGINIA
CITY OF RICHMOND, TO WIT:

I HEREBY CERTIFY, that on this ____ day of _____, 2016 before me, the subscriber, a Notary Public of the State aforesaid, personally appeared Richard W. Gregory, known to me, or satisfactorily proven to be, the person whose name is subscribed to the within instrument, and who acknowledged to be the Authorized Representative for South Canal, LLC, a Virginia limited liability company, and acknowledged that execution of the foregoing instrument for the purposes therein contained and acknowledged the same to be the lawful act and deed of the aforesaid corporation.

AS WITNESS my hand and Notarial Seal the day and year first above written.

NOTARY PUBLIC

My Commission Expires: _____
Registration No.: _____

GRANTEE-Acknowledged and Accepted

Selena Cuffee-Glenn
Chief Administrative Officer

GRANTEE'S ADDRESS
900 E. Broad Street
Richmond, Virginia 23219

APPROVED AS TO FORM



City Attorney's Office



Exhibit A
to
Special Warranty Deed

Legal Description

All that land lying and being in the City of Richmond and identified as Driveway Parcel (Parcel B), containing 0.197 acres, more or less, all as shown on that certain survey entitled "COMPILED EXHIBIT showing SOUTH CANAL DEVELOPMENT," Sheet 1 of 1, Job No. 56160036.00, prepared by Balzer and Associates, and dated June 1, 2016, a copy of which is attached hereto and made a part hereof, and, with reference to such survey, is more particularly described as follows:

Commencing at a point at the intersection of the North line of Hull Street U.S. Route 360, and the East line of Brander Street; thence continue along the North line of Hull Street, U.S. Route 360, N50°55'52"E, 105.00 feet to a point, said point being the point of beginning; thence departing the North line of Hull Street, U.S. Route 360, N47°40'42"W, 215.96 feet to a point; thence S84°37'37"E, 91.75 feet to a point; thence S39°46'08"E, 149.30 feet to a point situated on the North line of Hull Street, U.S. Route 360; thence continue along the North line of Hull Street, U.S. Route 360, S50°55'52"W, 35.00 feet to the point and place of beginning.

BEING a portion of the real property acquired by South Canal, LLC, from Fountainhead Acquisitions, LLC, by that certain Deed of Contribution, dated March 13, 2012, and recorded March 16, 2012, in the Clerk's Office, Circuit Court, City of Richmond, Virginia, as Instrument Number 12-5010, such portion being referred to as "Parcel F" therein.

* SOUTH CANAL DEVELOPMENT
 PRELIMINARY PLAN
 SHEET NO. 111 AND 112

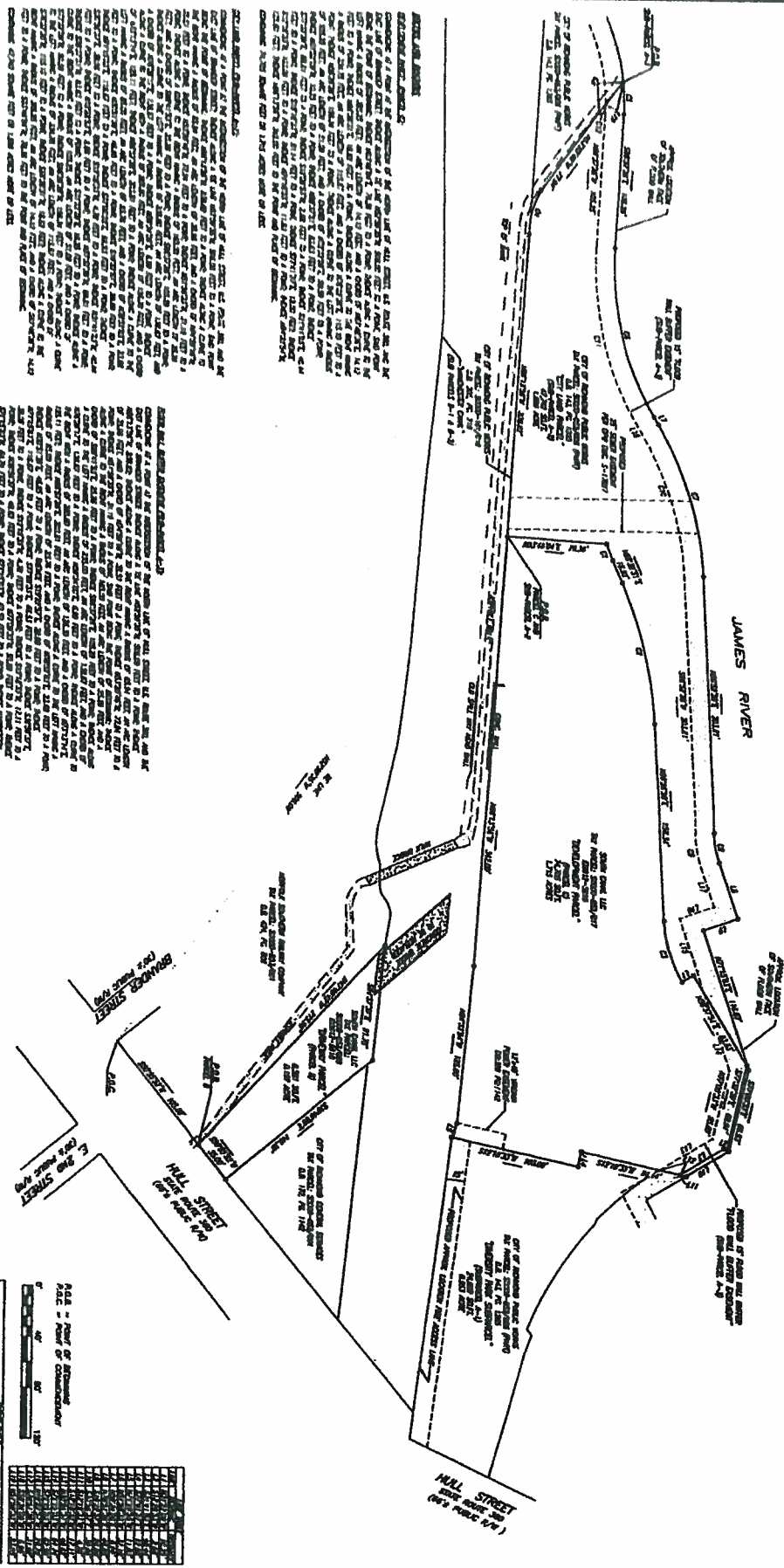

NOTE: THE ENGINEER HAS CONDUCTED VISUAL INSPECTIONS OF AREAS
 INDICATED BY SHADING AND HAS FOUND THEM TO BE SUITABLE FOR
 DEVELOPMENT. HOWEVER, THE ENGINEER HAS NOT CONDUCTED
 SURVEYS OF THESE AREAS AND IS NOT RESPONSIBLE FOR THE
 ACCURACY OF THE DIMENSIONS OF THESE AREAS. THE ENGINEER
 HAS CONDUCTED VISUAL INSPECTIONS OF AREAS INDICATED BY
 SHADING AND HAS FOUND THEM TO BE SUITABLE FOR DEVELOPMENT.
 ENGINEER APPROVES ONLY FOR SOUTH CANAL DEVELOPMENT.

SECTION 111 AND 112
 CONFORMANCE WITH THE REQUIREMENTS OF THE CITY OF RICHMOND, VIRGINIA, AND THE
 STATE OF VIRGINIA, AS APPLICABLE TO THE DEVELOPMENT OF THE SOUTH CANAL
 DEVELOPMENT, IS HEREBY CERTIFIED BY THE ENGINEER. THE ENGINEER HAS
 CONDUCTED VISUAL INSPECTIONS OF THE AREAS INDICATED BY SHADING AND
 HAS FOUND THEM TO BE SUITABLE FOR DEVELOPMENT. THE ENGINEER HAS
 NOT CONDUCTED SURVEYS OF THESE AREAS AND IS NOT RESPONSIBLE FOR THE
 ACCURACY OF THE DIMENSIONS OF THESE AREAS. THE ENGINEER APPROVES
 ONLY FOR SOUTH CANAL DEVELOPMENT.

SECTION 111 AND 112
 CONFORMANCE WITH THE REQUIREMENTS OF THE CITY OF RICHMOND, VIRGINIA, AND THE
 STATE OF VIRGINIA, AS APPLICABLE TO THE DEVELOPMENT OF THE SOUTH CANAL
 DEVELOPMENT, IS HEREBY CERTIFIED BY THE ENGINEER. THE ENGINEER HAS
 CONDUCTED VISUAL INSPECTIONS OF THE AREAS INDICATED BY SHADING AND
 HAS FOUND THEM TO BE SUITABLE FOR DEVELOPMENT. THE ENGINEER HAS
 NOT CONDUCTED SURVEYS OF THESE AREAS AND IS NOT RESPONSIBLE FOR THE
 ACCURACY OF THE DIMENSIONS OF THESE AREAS. THE ENGINEER APPROVES
 ONLY FOR SOUTH CANAL DEVELOPMENT.



SCALE - 1" = 50'
 DATE - JUNE 1, 1911
 SHEET NO. 111

COMPILED EXHIBIT
 SHOWING
 SOUTH CANAL DEVELOPMENT
 CITY OF RICHMOND, VIRGINIA

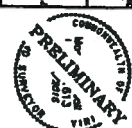

111 and 112
 SHEET NO. 111 AND 112

EXHIBIT E
TO
DEVELOPMENT AND COOPERATION AGREEMENT

Canal Parcel and Floodwall Parcel Quitclaim Deed

[Attached Hereto]

EXHIBIT E
to
Development Agreement

***THIS INSTRUMENT IS EXEMPT FROM RECORDATION TAX
PURSUANT TO THE PROVISIONS OF VA. CODE § 58.1-811(A)(3).***

Consideration: \$ n/a
Tax Assessment: \$

PREPARED BY AND RETURN TO:

Richard W. Gregory, Esquire
Atlas Law, PLC
7 East Second Street
Richmond, Virginia 23224

GPIN Numbers: S0000052006, part of S0000101010, and S0000052017 by reference

DEED OF QUIT CLAIM

THIS DEED OF QUIT CLAIM (“Agreement”) is made this _____ day of _____, 201____, by **SOUTH CANAL, LLC**, a Virginia limited liability company (“Grantor”), and **CITY OF RICHMOND, VIRGINIA**, a municipal corporation of the Commonwealth of Virginia (“Grantee”).

WITNESSETH:

WHEREAS, Grantor and Grantee entered into that certain Development and Cooperation Agreement dated _____ (the “Development Agreement”), and

WHEREAS, Grantee is the owner of (1) that certain parcel of real property, together with the improvements thereon and the appurtenances thereunto belonging, including but not limited to a flood wall designated as Tax Map Parcel No. S0000052006 (the “Flood Wall Parcel”), and (2) a portion of that certain parcel of real property, together with any and all improvements located thereon and the appurtenances thereunto belonging, designated as Tax Map Parcel No. S0000101010 (such portion being referred to herein as “Canal Parcel”). The Flood Wall Parcel and Canal Parcel shall be collectively referred to herein as the “City Parcels” as more particularly described on **Exhibit A** attached hereto and made a part hereof, and

WHEREAS, Grantor is the owner of (1) that certain parcel of real property, together with the improvements thereon and the appurtenances thereunto belonging, designated as Tax Map Parcel Nos. S0000052017, which it acquired from Fountainhead Acquisitions, LLC, by deed, dated March 13, 2012, and recorded March 16, 2012, in the Clerk’s Office, Circuit Court, City of Richmond, Virginia (“Clerk’s Office”), as Instrument Number 12-5010 (the “Development Parcel Deed”), which parcel is more particularly described on **Exhibit B** attached hereto and

made a part hereof (the "Development Parcel"), and (2) that certain parcel of real property acquired from the City of Richmond, pursuant to the Development Agreement, by deed dated _____, recorded on _____ in the Clerk's Office as Instrument Number _____, such property formerly being a portion of Tax Map Parcel No. S0000052006, and more particularly described on **Exhibit C** attached hereto and made a part hereof (the "Former City Land Parcel"), and

WHEREAS, in addition to conveying the Development Parcel, the Development Parcel Deed, in error, purports to convey certain property located on the Flood Wall Parcel, which property could not be conveyed by the Development Parcel Deed because at the time of the execution and recordation of such deed, such property was owned (and remains owned) in fee simple by the City, being previously conveyed to the City by such duly executed and recorded deeds described in Exhibit A, and

WHEREAS, to correct such error in the chain of title and achieve other goals of the parties set forth in the Development Agreement, the Development Agreement requires Grantor to convey any interest Grantor may have in the City Parcels by this Deed of Quit Claim.

NOW THEREFORE, for and in consideration of the sum of Ten Dollars (\$10.00) cash in hand paid by Grantee to Grantor, and other good and valuable consideration, the receipt and sufficiency of which are hereby acknowledged, and pursuant to the Development Agreement, Grantor does hereby quit-claim unto the Grantee any and all of Grantor's right, title and interest in and to all that certain real property, together with the improvements thereon and appurtenances thereunto belonging, located in the City of Richmond, Virginia, known as Tax Map Parcel S0000052006 and a portion of Tax Map Parcel S0000101010, Richmond, Virginia, which property is more particularly described as follows:

See Exhibit "A" Attached Hereto

The RECITALS above are incorporated herein by this reference.

[SIGNATURES APPEAR ON THE FOLLOWING PAGE]

Witness the following signatures.

GRANTOR:
SOUTH CANAL, LLC,
A Virginia limited liability company

By: _____
Richard W. Gregory,
Authorized Representative

ACKNOWLEDGMENT

COMMONWEALTH OF VIRGINIA
CITY OF RICHMOND, TO WIT:

I HEREBY CERTIFY, that on this ____ day of 2016, before me, the subscriber, a Notary Public of the State aforesaid, personally appeared Richard W. Gregory, known to me, or satisfactorily proven to be, the person whose name is subscribed to the within instrument, and who acknowledged to be the Authorized Representative for SOUTH CANAL, LLC, a Virginia limited liability company, and acknowledged that execution of the foregoing instrument for the purposes therein contained and acknowledged the same to be the lawful act and deed of the aforesaid corporation.

AS WITNESS my hand and Notarial Seal the day and year first above written.

NOTARY PUBLIC

My Commission Expires: _____
Registration No.: _____

Acknowledged and accepted:
GRANTEE, City of Richmond, Virginia

Chief Administrative Officer

Approved as to Form:

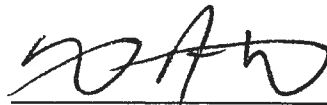

Assistant City Attorney



GRANTEE'S ADDRESS
900 E. Broad Street
Richmond, Virginia 23219

Exhibit A
to
Canal Parcel and Flood Wall Parcel Quit Claim Deed

Legal Description of City Parcels

ALL that certain property located in the City of Richmond and more particularly described as follows:

Portion 1 of the City Parcels (being a part of Tax Map Parcel No. S0000052006):

ALL that certain tract of land with all improvements thereon and appurtenances thereto belonging lying on the South bank of the James River immediately West of the abutment of the Mayo Bridge and Hull Street in the City of Richmond, Virginia all as more particularly shown as Parcel "A" and Parcel "B" on a "PLAT OF STANDARD PAPER MFG. CO. BUILDING AND PARCEL OF LAND SAID BUILDING SITUATED THEREON, RICHMOND, VIRGINIA" dated February 13, 1979 drawn by William J. Schmidt & Assoc., Engineers & Surveyors, a copy of which plat is attached hereto and incorporated by reference.

BEING the same real estate conveyed to the City of Richmond from Ross Investment Corporation by that certain Order Directing the Recordation of the Vesting of Title, dated September 29, 1987, recorded on October 6, 1987, in Deed Book 143 at page 1265, in the Clerk's Office, and the same real estate conveyed to Ross Investment Corporation from Virginia Electric and Power Company with special warranty of title by the certain Agreement and Deed dated February 12, 1979, recorded on February 13, 1979, in Deed Book 555 at page 195, in the Clerk's Office. PARCEL "A" further BEING a part of the same real estate conveyed to Virginia Railway and Power Company by deed from Hill Carter, et als, Special Masters, dated June 29, 1909 and recorded July 1, 1909 in deed book 32, page 271 in the Circuit Court of the City of Richmond, Virginia, Division Two: the Virginia Railroad and Power Company having duly changed its name to the Virginia Electric and Power Company. Parcel "B" further being the same real estate conveyed to Standard Paper Manufacturing Company by deed from Manchester Board and Paper Company, Incorporated, dated November 17, 1947, recorded December 5, 1947 in deed book 115, page 312 in the aforesaid Clerk's Office.

Portion 2 of the City Parcels (being a being a part of Tax Map Parcel No. S0000052006):

BEGINNING at a point on the common division line between property formerly owned by Manchester Board and Paper Co., Inc. and property formerly owned by Ross Investment Corp. on the South edge of the James River, thence S12°50'01"W a distance of 62+ feet to a point; thence N31°09'35"W a distance of 43.23 feet to a point; thence N13°00'21"E a distance of 2.68 feet to a point; thence N76°59'39"W a distance of 67.23 feet to a point; thence S59°09'19W a distance of 81.98 feet to a point; thence S30°50'41"E (radial) a distance of 10.25 feet to a point; thence on a curve deflecting to the Right having a radius of 105.25 feet and having a length of 51.09 feet to a point;

thence S86°57'56"W a distance of 156.34 feet to a point; thence on a curve defecting to the Right having a radius of 334.75 feet and a length of 115.68 feet to a point; thence S67°09'59"W a distance of 18.92 feet to a point; thence on a curve deflecting to the right having a radius of 385.25 feet and having a length of 14.17 feet to a point on the common division line between property formerly owned by Manchester Board and Paper Co., Inc. and property formerly owned by ReeTree Partnership; thence N4°17'32"E a distance of 70.66 feet to a rod; thence N4°17'32"E a distance of 37+ feet to the South edge of the James River; thence Eastwardly along the South edge of the James River a distance of 512+ feet to the point of beginning. Said point of beginning being the 341+ feet Westwardly along the South edge of the James River from the West line of the Mayo's Bridge, all as shown shaded on Parcel 2 of the Department of Public Works Drawing No. 0-21676, Sheet 1, attached hereto as "Schedule A", and containing 34,513+ square feet (0.79+ acres).

BEING a the same real estate conveyed in fee simple to the City of Richmond with Special Warranty of Title from Manchester Board and Paper, Co. by that by that certain Deed, Deed of Easement, and Deed of Partial Release, dated January 11, 1988, recorded February 11, 1988, in Deed Book 156 at page 897, in the Clerk's Office.

Portion 3 (being a part of Tax Map Parcel No. S0000052006):

ALL that certain piece or parcel of land, together with the buildings and improvements thereon and appurtenances thereto belonging, lying and being in the City of Richmond, Virginia, on the South side of the James River, which is known and designated as 1.25 + or - acres parcel of land, with improvements thereon, being the Western-most part of property formerly owned by Manchester Board and Paper, Co., Inc., as designated on a Physical Survey made by Austin Brockenbrough and Associates, Consulting Engineers, in the City of Richmond, Virginia, dated November 19, 1979, which is attached hereto and to which reference is made hereby for a more particular description of the property.

BEING that same real estate acquired by the City of Richmond from ReeTree Partnership, etc., et. al, and any other owners thereof, by that certain Order Directing the Recordation of the Vesting of Title, dated September 29, 1987, recorded on October 6, 1987, in Deed Book 143 at page 1271, in the Clerk's Office, and BEING the same real estate conveyed to ReeTree Partnership with general warranty of title from Manchester Board and Paper Co., Inc., by that certain Deed and Bargain of Sale, dated December 10, 1979, recorded December 21, 1979, in Deed Book 560, at page 1189, in the Clerk's Office.

Portion 4 (being a part of Tax Map Parcel No. S0000052006 and a part of Tax Map Parcel No. S0000101010):

ALL that certain piece or parcel of land lying and being in the City of Richmond, Virginia BEING that same property conveyed to the City of Richmond from Virginia Electric and Power Company ("VEPCO") by that certain Special

Warranty Deed, dated June 9, 1989, recorded June 16, 1989, in Deed Book 205, at page 212, in the Clerk's Office, and BEING identified as Parcel 4, containing 2.43 acres, more or less, all as shown by shading on that certain Plat of Survey entitled "Proposed Dedication Of Property West Of Mayo's Bridge, Between The James River And Southern Railway R/W, For Floodwall Purposes (Southside Protection)," Sheet 2 of 3, Drawing No. 0-21890, Prepared by the Department of Public Works, Richmond, Virginia, and dated August 1, 1988, a copy of which is attached hereto and made a part hereof and, with reference to such Plat is more particularly described as follows:

BEGINNING at a point in the property line dividing property formerly owned by the VEPCO and property now or formerly owned by the City of Richmond, Virginia, which point is N. 82° 10' 02" W. 20.98 feet from a property corner; thence S. 50° 49' 08" W. 93.62 feet along the westerly line of Hull Street to a point; thence N. 83° 44' 22" W. 203.48 feet along the property line dividing property formerly owned by VEPCO and property now or formerly owned by said City of Richmond to a point; thence N. 39° 52' 52" W. 4.30 feet along the property line dividing property formerly owned by VEPCO and property formerly owned by Manchester Board and Paper Company, Inc. to a point; thence N. 84° 44' 21" W. 97.75 feet along said property line to a point; thence northwestwardly 900 feet, more or less, along the property line dividing property formerly owned by VEPCO and property formerly owned by Southern Railway Company to a point in the property line dividing property and property formerly owned by Southern Railway Company; thence northeastwardly 125 feet, more or less, along said property line to a point; thence northeastwardly 115 feet, more or less, along said property line to a point; thence northeastwardly 105 feet, more or less, along said property line to a point in the southerly line of the James River; thence eastwardly 95 feet, more or less, along the southerly line of the James River to a point; thence S. 40° 54' 32" W. 68 feet, more or less, along the property line dividing property formerly owned by VEPCO and the property now or formerly owned by the City of Richmond to a point; thence S. 40° 54' 32" W. 155.60 feet along said property line to a point, marked by an iron pin; thence S. 85° 42' 28" E. 352.00 feet along said property line to a point, marked by a spike; thence S. 85° 42' 28" E. 342.00 feet along the property line dividing property formerly owned by VEPCO and property formerly owned by Manchester Board and Paper Company, Inc. to a point; thence S. 84° 02' 26" E. 125.60 feet along said property line to a point; thence S. 70° 39' 27" E. 11.83 feet along said property line to a point; thence S. 82° 10' 02" E. 239.87 feet along the property line dividing property formerly owned by VEPCO and property now or formerly owned by the City of Richmond to the point of beginning.

LESS AND EXCEPT all such property conveyed to South Canal, LLC, from the City of Richmond pursuant to the Development Agreement, by deed dated _____, 20 __, and recorded immediately preceding the recordation of this DEED in deed book __, page __, in the Circuit Court of the City of Richmond, such property being referred to herein as the Former City Land Parcel and more particularly described as:

All that land lying and being in the City of Richmond and identified as City Land (Sub-Parcel A-2), containing 1.096 acres, more or less, all as shown on that certain survey entitled "COMPILED EXHIBIT showing SOUTH CANAL DEVELOPMENT," Sheet 1 of 1, Job No. 56160036.00, prepared by Balzer and Associates, and dated June 1, 2016, a copy of which is attached hereto and made a part hereof, and, with reference to such survey, is more particularly described as follows:

COMMENCING at a point at the intersection of the North line of Hull Street, U.S. Route 360, and the East line of Brander Street; thence along a tie line N52°59'35"W, 506.00 feet to a point, said point being the POINT OF BEGINNING; thence N86°13'56"W, 238.82 feet to a point; thence along a curve to the right having a radius of 65.94 feet, an arc length of 35.96 feet, and a chord of N74°59'10"W, 35.51 feet to a point; thence N53°20'46"W, 77.04 feet to a point; thence N51°58'33"W, 31.19 feet to a point; thence along a curve to the right having a radius of 165.00 feet, an arc length of 25.29 feet, and a chord of S88°41'53"E, 25.26 feet to a point; thence S86°37'26"E, 105.29 feet to a point; thence along a curve to the left having a radius of 235.00 feet, an arc length of 138.67 feet, and a chord of N76°28'17"E, 136.67 feet to a point; thence N59°34'00"E, 6.99 feet to a point; thence along a curve to the right with a radius of 265.00 feet, an arc length of 126.30 feet, and a chord of N73°13'14"E, 125.11 feet; thence N86°52'28"E, 203.81 feet to a point; thence along a curve to the left having a radius of 85.00 feet, an arc length of 23.76 feet, and a chord of N78°52'03"E, 23.68 feet to a point; thence N70°51'39"E, 46.85 feet to a point; thence S19°22'57"E, 28.88 feet to a point; thence N71°15'03"E, 116.67 feet to a point; thence S77°00'33"E, 66.53 feet to a point; thence S30°56'37"E, 39.06 feet to a point; thence S12°18'33"W, 4.78 feet to a point; thence N31°41'03"W, 40.44 feet to a point; thence N12°28'53"E, 2.68 feet to a point; thence N77°32'39"W, 68.01 feet to a point; thence S58°37'51"W, 83.63 feet to a point; thence S31°22'09"E, 10.25 feet to a point; thence along a curve to the right having a radius of 105.25, an arc length of 51.09 feet, and a chord of S72°32'09"W, 50.59 feet to a point; thence S86°26'28"W, 156.34 feet to a point; thence along a curve to the Left having a radius of 334.75 feet, an arc length of 115.67 feet, and a chord of S76°32'30"W, 115.10 feet to a point; thence S66°38'31"W, 18.92 feet, thence along a curve to the right having a radius of 385.25 feet, an arc length of 14.12 feet, and a chord of S67°48'36"W, 14.12 feet to a point; thence S03°46'04"W, 79.36 feet to the POINT AND PLACE OF BEGINNING.

Exhibit B
to
Canal Parcel and Flood Wall Parcel Quit Claim Deed

Legal Description of Development Parcel

Development Parcel (Tax Parcel ID S0000052017):

All that land lying and being in the City of Richmond and identified as Development Parcel (Parcel C), containing 1.715 acres, more or less, all as shown on that certain survey entitled "COMPILED EXHIBIT showing SOUTH CANAL DEVELOPMENT," Sheet 1 of 1, Job No. 56160036.00, prepared by Balzer and Associates, and dated June 1, 2016, a copy of which is attached hereto and made a part hereof, and, with reference to such survey, is more particularly described as follows:

COMMENCING at a point at the intersection of the North line of Hull Street, U.S. Route 360, and the East line of Brander Street; thence along a tie line N52°59'35"W, 506.00 feet to a point, said point being the POINT OF BEGINNING; thence N03°46'04"E, 79.36 feet to a point; thence along a curve to the left having a radius of 385.25 feet, an arc length of 14.12 feet, and a chord of N67°48'36"E, 14.12 feet to a point; thence N66°38'31"E, 18.92 feet to a point; thence along a curve to the right having a radius of 334.75 feet, an arc length of 115.67 feet, and a chord of N76°32'30"E, 115.10 feet to a point; thence N86°26'28"E, 156.34 feet to a point; thence along a curve to the left having a radius of 105.25 feet, an arc length of 51.09 feet, and a chord N72°32'09"E, 50.59 feet to a point; thence N31°22'09"W, 10.25 feet to a point; thence N58°37'51"E, 83.63 feet to a point; thence S77°32'39"E, 68.01 feet to a point; thence S12°28'53"W, 2.68 feet to a point; thence S31°41'03"E, 40.44 feet to a point; thence S12°18'33"W, 81.14 feet to a point; thence S77°41'27"E, 12.00 feet; thence S12°18'33"W, 103.00 feet to a point; thence N71°10'55"W, 11.83 feet to a point; thence N84°33'54"W, 125.60 feet; thence N86°13'56"W, 342.00 feet to the POINT AND PLACE OF BEGINNING.

Exhibit C
to
Canal Parcel and Flood Wall Parcel Quit Claim Deed

Legal Description of Former City Land Parcel

Former City Land Parcel (formerly a portion of Tax Parcel ID S0000052006):

All that land lying and being in the City of Richmond and identified as City Land (Sub-Parcel A-2), containing 1.096 acres, more or less, all as shown on that certain survey entitled "COMPILED EXHIBIT showing SOUTH CANAL DEVELOPMENT," Sheet 1 of 1, Job No. 56160036.00, prepared by Balzer and Associates, and dated June 1, 2016, a copy of which is attached hereto and made a part hereof, and, with reference to such survey, is more particularly described as follows:

COMMENCING at a point at the intersection of the North line of Hull Street, U.S. Route 360, and the East line of Brander Street; thence along a tie line N52°59'35"W, 506.00 feet to a point, said point being the POINT OF BEGINNING; thence N86°13'56"W, 238.82 feet to a point; thence along a curve to the right having a radius of 65.94 feet, an arc length of 35.96 feet, and a chord of N74°59'10"W, 35.51 feet to a point; thence N53°20'46"W, 77.04 feet to a point; thence N51°58'33"W, 31.19 feet to a point; thence along a curve to the right having a radius of 165.00 feet, an arc length of 25.29 feet, and a chord of S88°41'53"E, 25.26 feet to a point; thence S86°37'26"E, 105.29 feet to a point; thence along a curve to the left having a radius of 235.00 feet, an arc length of 138.67 feet, and a chord of N76°28'17"E, 136.67 feet to a point; thence N59°34'00"E, 6.99 feet to a point; thence along a curve to the right with a radius of 265.00 feet, an arc length of 126.30 feet, and a chord of N73°13'14"E, 125.11 feet; thence N86°52'28"E, 203.81 feet to a point; thence along a curve to the left having a radius of 85.00 feet, an arc length of 23.76 feet, and a chord of N78°52'03"E, 23.68 feet to a point; thence N70°51'39"E, 46.85 feet to a point, thence S19°22'57"E, 28.88 feet to a point; thence N71°15'03"E, 116.67 feet to a point; thence S77°00'33"E, 66.53 feet to a point; thence S30°56'37"E, 39.06 feet to a point; thence S12°18'33"W, 4.78 feet to a point; thence N31°41'03"W, 40.44 feet to a point; thence N12°28'53"E, 2.68 feet to a point; thence N77°32'39"W, 68.01 feet to a point; thence S58°37'51"W, 83.63 feet to a point; thence S31°22'09"E, 10.25 feet to a point; thence along a curve to the right having a radius of 105.25, an arc length of 51.09 feet, and a chord of S72°32'09"W, 50.59 feet to a point; thence S86°26'28"W, 156.34 feet to a point; thence along a curve to the Left having a radius of 334.75 feet, an arc length of 115.67 feet, and a chord of S76°32'30"W, 115.10 feet to a point; thence S66°38'31"W, 18.92 feet, thence along a curve to the right having a radius of 385.25 feet, an arc length of 14.12 feet, and a chord of S67°48'36"W, 14.12 feet to a point; thence S03°46'04"W, 79.36 feet to the POINT AND PLACE OF BEGINNING.

BEING the same property conveyed to South Canal, LLC, from the City of Richmond pursuant to the Development Agreement, by deed dated _____, 20 __, and recorded immediately preceding the recordation of this DEED in deed book __, page __, in the Circuit Court of the City of Richmond.

PLAT OF SURVEY

JAMES RIVER

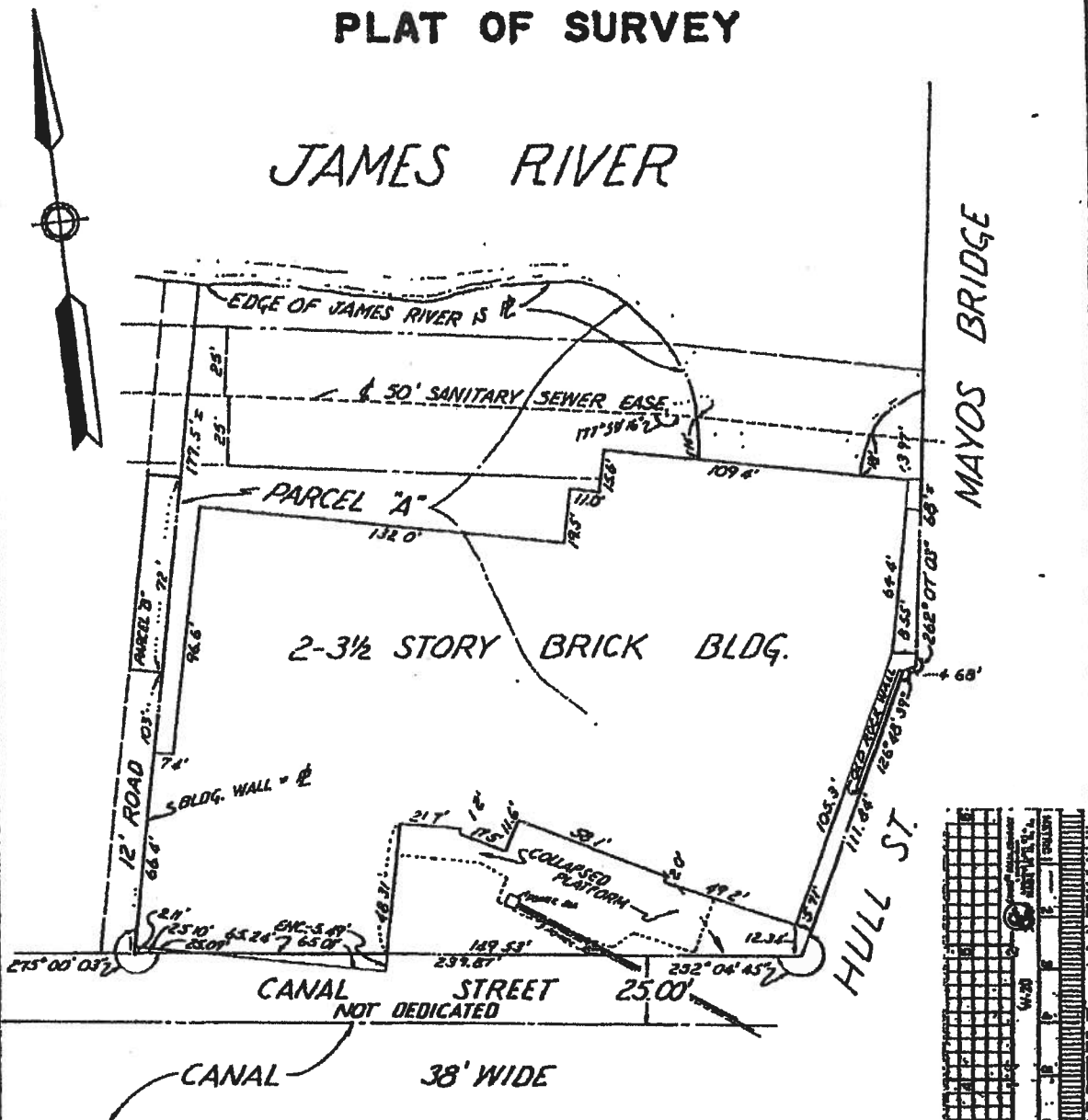

AREA OF PARCEL "A" = 1.34 ± ACS.
 AREA OF PARCEL "B" = 0.02 ± AC.

PLAT OF STANDARD PAPER MFG. CO.
 BUILDING AND PARCEL OF
 LAND SAID BUILDING SITUATED
 THEREON
 RICHMOND, VIRGINIA

SCALE: 1" = 50'
 DATE: FEB. 13, 1979

WILLIAM J. SCHMIDT & ASSOC.
 ENGINEERS & SURVEYORS
 4916 W. MARSHALL ST. - RICHMOND, VA.

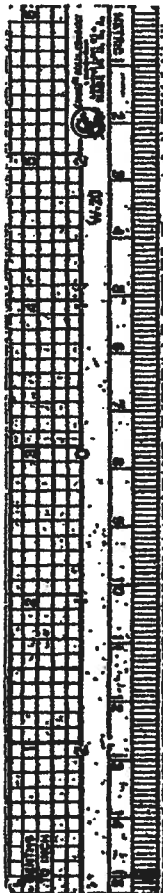

78000

Project Name	156-891
Project No.	PB 38-82
City	Richmond, Virginia
County	Richmond
Map No.	156-891
Scale	1" = 100'
Date	10/1/52
Author	J. H. Smith
Checker	J. H. Smith
Appr.	J. H. Smith
City Engineer	J. H. Smith
City Manager	J. H. Smith
City Clerk	J. H. Smith
City Assessor	J. H. Smith
City Auditor	J. H. Smith
City Treasurer	J. H. Smith
City Attorney	J. H. Smith
City Engineer	J. H. Smith
City Manager	J. H. Smith
City Clerk	J. H. Smith
City Assessor	J. H. Smith
City Auditor	J. H. Smith
City Treasurer	J. H. Smith
City Attorney	J. H. Smith

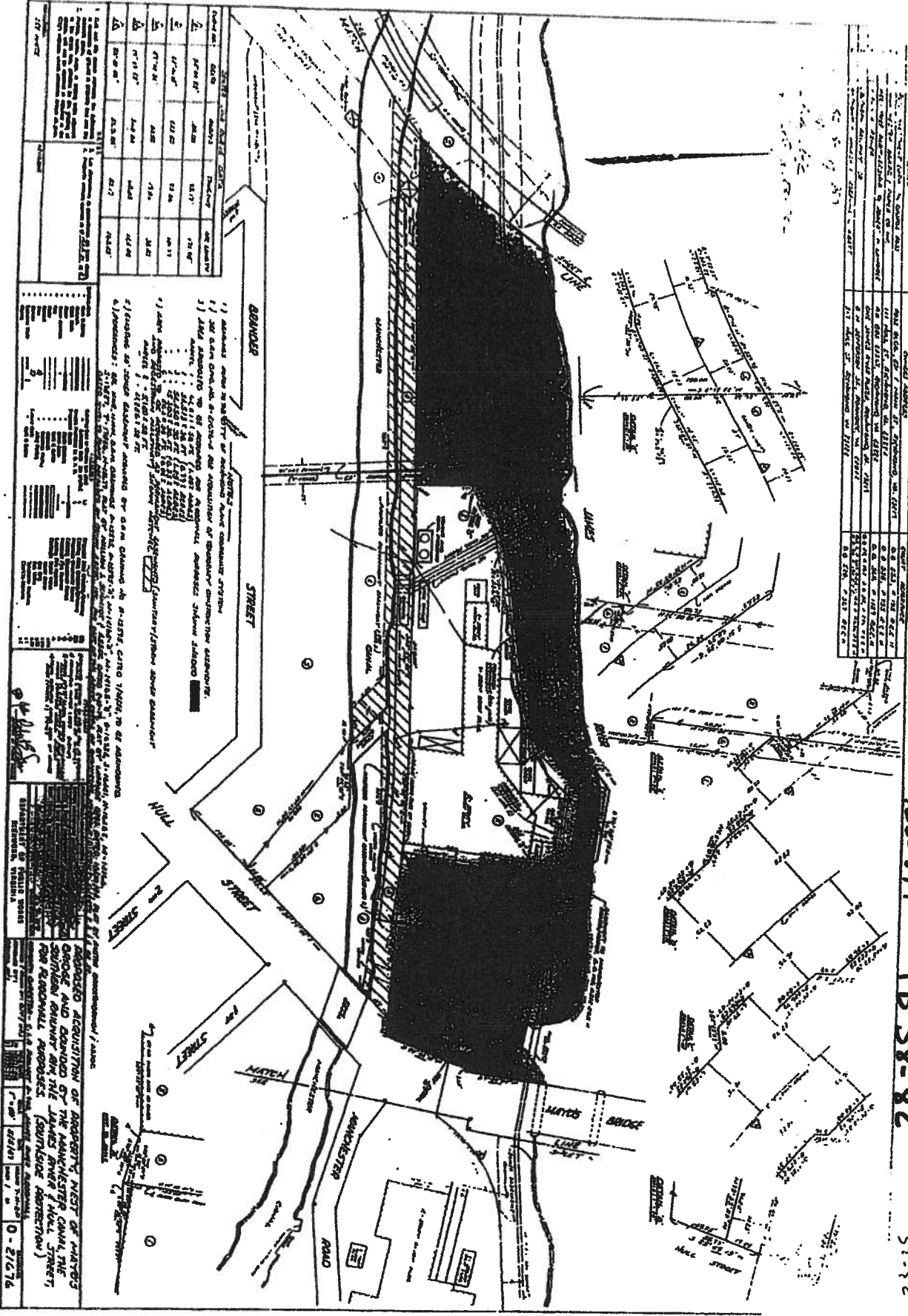

156-891

PB 38-82

35-52

DRW. BY. NO. 0-21676

HOW OF PROPERTY
WEPCO

RESOURCES
IN CITY OF RICHMOND AND DISTRICT OF T-1280
DATED 4-18-68
D. PART OF THE LANDS DATED 07/18/68

PLAN SHOWING A 125+ ACRE PARCEL OF
LAND WITH IMPROVEMENTS THEREON
BEING THE WESTERN MOST PART OF PROPERTY
OWNED BY MANCHESTER BOARD & PAPER
COMPANY, LOCATED IN THE CITY
OF RICHMOND, VIRGINIA

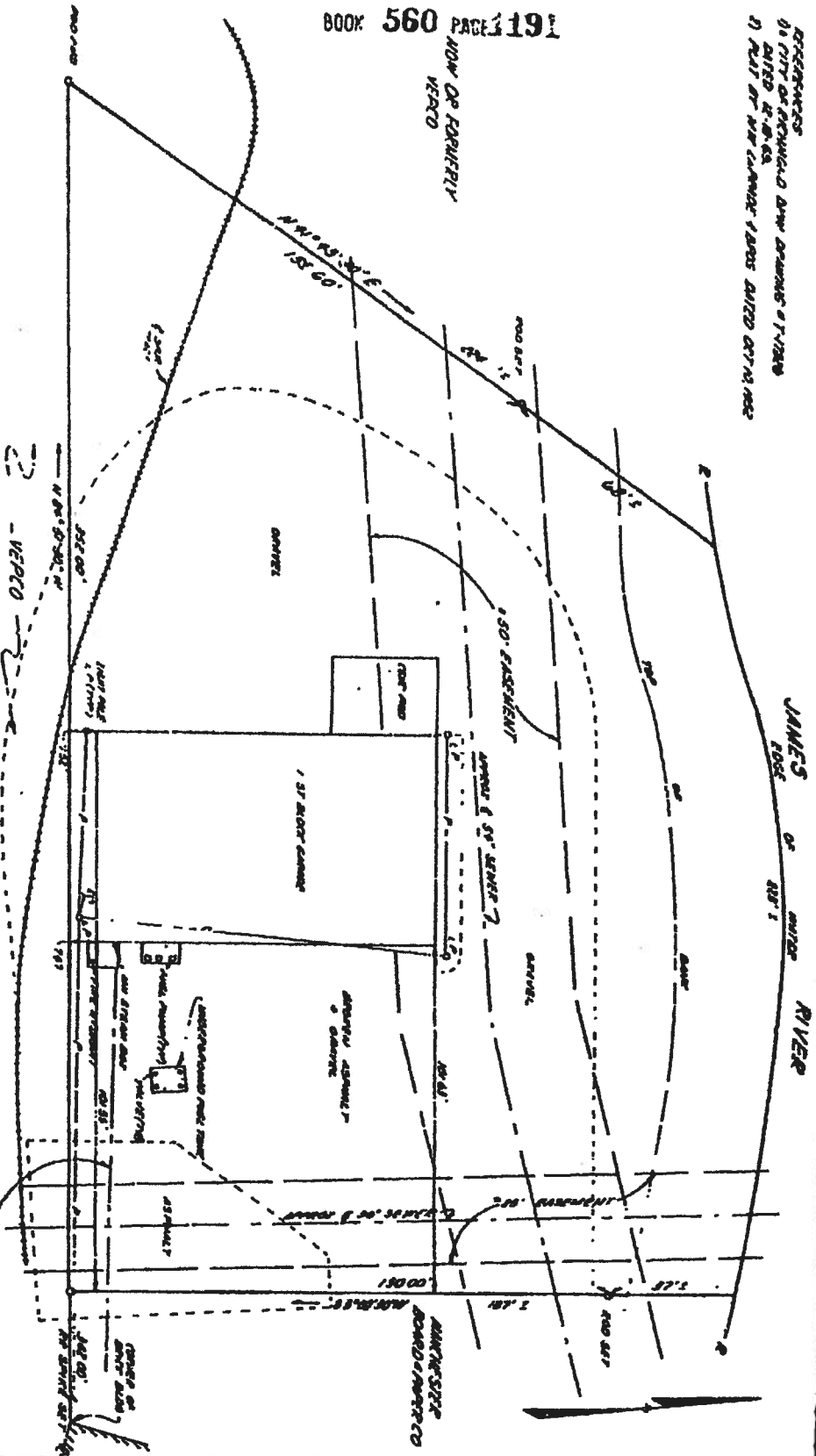

**AUSTIN BROCKENBROUGH
AND ASSOCIATES**
CONSULTING ENGINEERS

IN THE CITY OF RICHMOND, VIRGINIA
DATE OF SURVEY: 11/1/68
SCALE: AS SHOWN
PROJECT: 1/1

111
C-2718

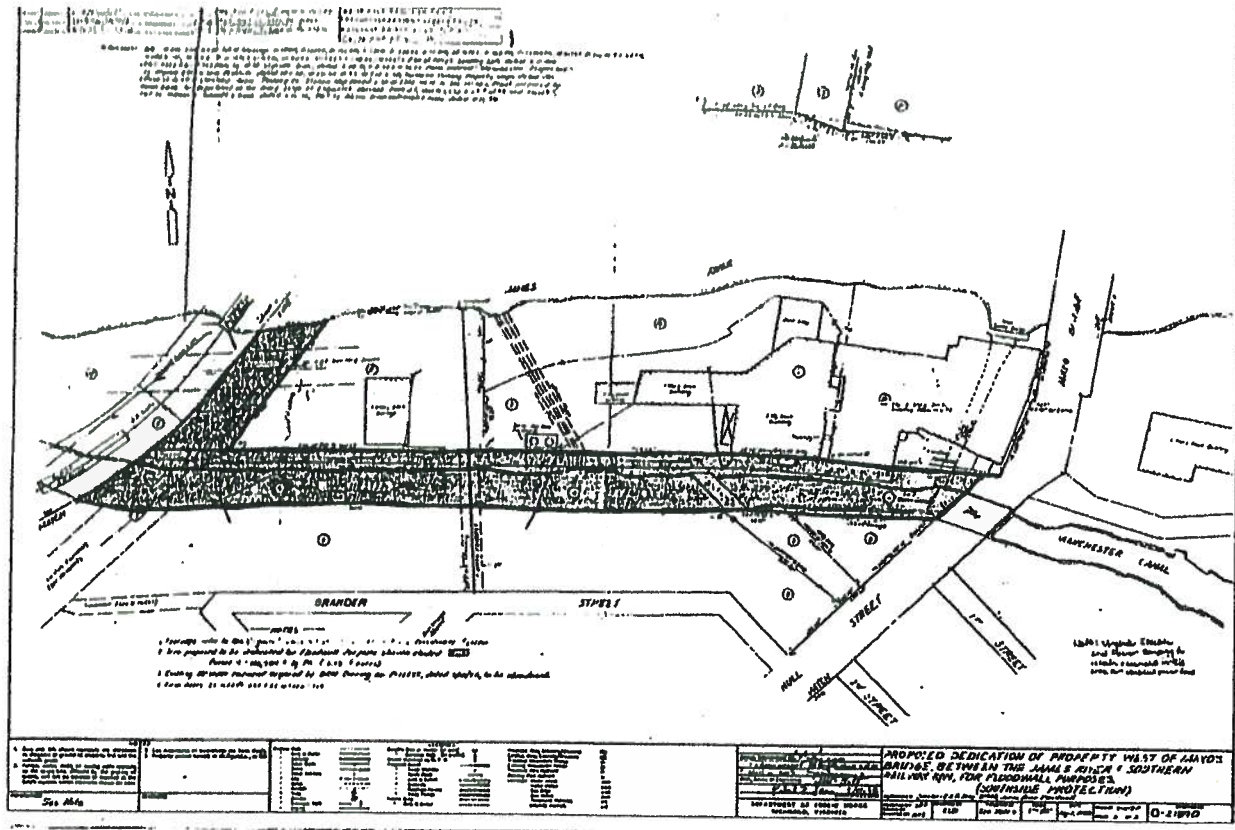

DPW dwg. NO. 0-21890



THE ENGINEER HAS CONDUCTED VISUAL SURVEYS OF THE PROPOSED CANALS AND HAS CONDUCTED VISUAL SURVEYS OF THE PROPOSED CANALS AND HAS CONDUCTED VISUAL SURVEYS OF THE PROPOSED CANALS...

EXHIBIT MAPS ONLY FOR SOUTH CANAL DEVELOPMENT

* EXHIBIT MAPS ONLY FOR SOUTH CANAL DEVELOPMENT

* EXHIBIT MAPS ONLY FOR SOUTH CANAL DEVELOPMENT

* EXHIBIT MAPS ONLY FOR SOUTH CANAL DEVELOPMENT

* EXHIBIT MAPS ONLY FOR SOUTH CANAL DEVELOPMENT

* EXHIBIT MAPS ONLY FOR SOUTH CANAL DEVELOPMENT

* EXHIBIT MAPS ONLY FOR SOUTH CANAL DEVELOPMENT

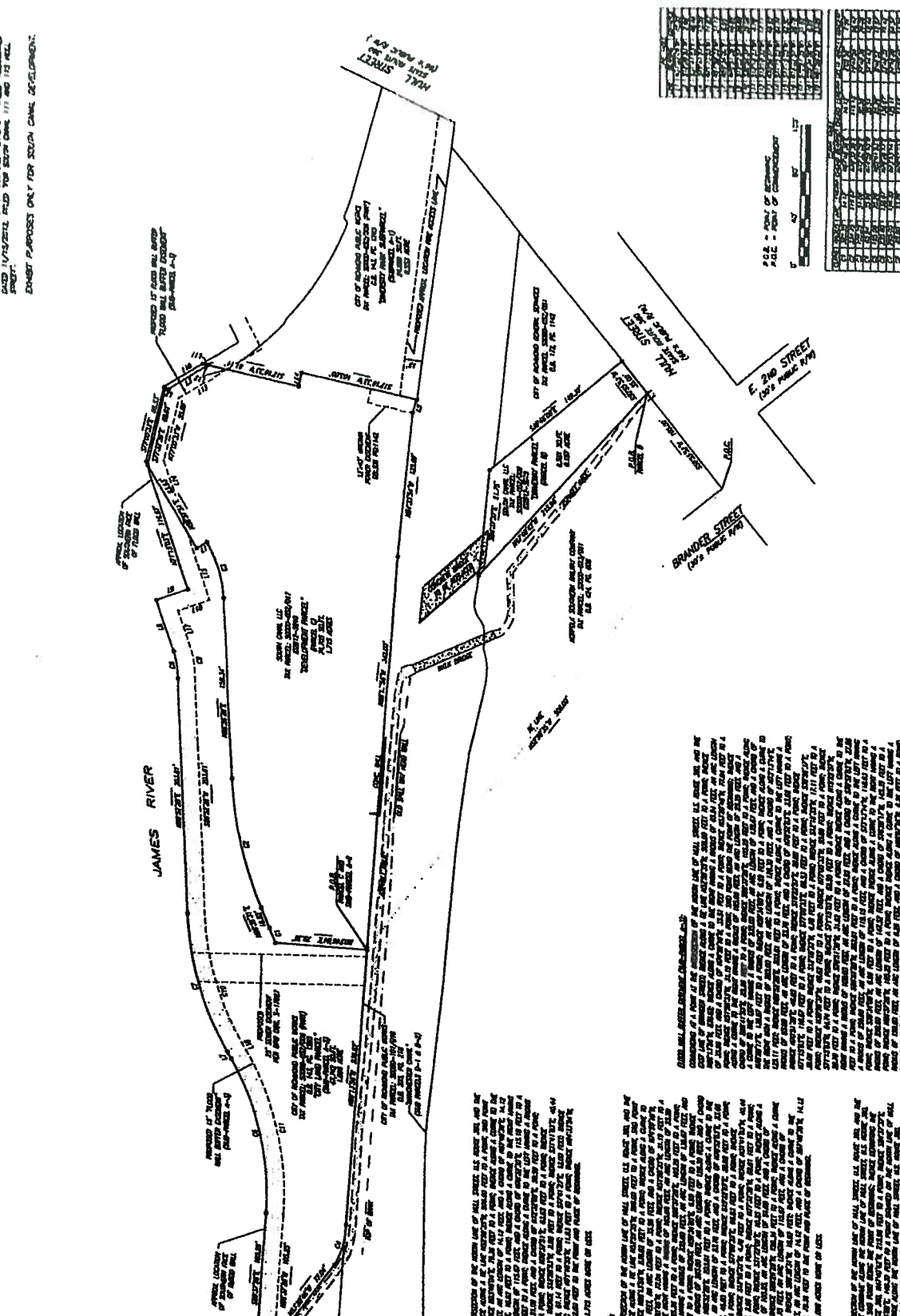

THE ENGINEER HAS CONDUCTED VISUAL SURVEYS OF THE PROPOSED CANALS AND HAS CONDUCTED VISUAL SURVEYS OF THE PROPOSED CANALS...

AREA	AREA	AREA	AREA	AREA	AREA	AREA	AREA	AREA	AREA
1	2	3	4	5	6	7	8	9	10
11	12	13	14	15	16	17	18	19	20
21	22	23	24	25	26	27	28	29	30
31	32	33	34	35	36	37	38	39	40
41	42	43	44	45	46	47	48	49	50
51	52	53	54	55	56	57	58	59	60
61	62	63	64	65	66	67	68	69	70
71	72	73	74	75	76	77	78	79	80
81	82	83	84	85	86	87	88	89	90
91	92	93	94	95	96	97	98	99	100

THE ENGINEER HAS CONDUCTED VISUAL SURVEYS OF THE PROPOSED CANALS AND HAS CONDUCTED VISUAL SURVEYS OF THE PROPOSED CANALS...

EXHIBIT MAPS ONLY FOR SOUTH CANAL DEVELOPMENT

* EXHIBIT MAPS ONLY FOR SOUTH CANAL DEVELOPMENT

**EXHIBIT F
TO
DEVELOPMENT AND COOPERATION AGREEMENT**

City Land Deed

[Attached Hereto]

EXHIBIT F

to

Development Agreement

PREPARED BY AND RETURN TO:

Richard W. Gregory, Esquire
Atlas Law, PLLC
7 East Second Street
Richmond, Virginia 23224

GPIN Number: A Portion of S000052006

Consideration: \$ _____
Tax Assessment: \$ _____

***THIS INSTRUMENT IS EXEMPT FROM GRANTOR'S TAX
PURSUANT TO THE PROVISIONS OF VA. CODE § 58.1-811(C)(4)***

DEED

THIS DEED is made this ____ day of _____, 20____, by CITY OF RICHMOND, VIRGINIA, a municipal corporation of the Commonwealth of Virginia ("Grantor"), and SOUTH CANAL, LLC, a Virginia limited liability company ("Grantee"), whose mailing address is P.O. Box 363, Richmond, Virginia 23224.

WITNESSETH:

In consideration of the sum of Ten Dollars (\$10.00) cash in hand paid by Grantee to Grantor, and other good and valuable consideration, the receipt and sufficiency of which are hereby acknowledged, Grantor does hereby grant and convey with General Warranty, unto the Grantee all that certain real property located in the City of Richmond, Virginia, being a portion of Tax Map Parcel S000052006, Richmond, Virginia, which property is more particularly described as follows (the "Property"):

See Exhibit "A" Attached Hereto

This conveyance is made subject to all applicable easements, conditions, restrictions of record, and the following.

Grantor and Grantee acknowledge that they have entered into that certain Development and Cooperation Agreement, dated _____ (the "Development Agreement"), and that this Deed is intended to be executed together with the other documents provided for in the Development Agreement and placed in escrow pursuant to the escrow agreement entered into pursuant to such Development Agreement (the "Escrow Agreement"). The Development Agreement and Escrow Agreement require that multiple deeds (referred to and defined in each agreement as (1) the Driveway Deed, (2) the Canal Parcel and Flood Wall Parcel Quitclaim Deed, (3) the Storm Water Easement, and (4) the City Flood Wall Buffer and Access Agreement

and Deed of Easements) be released from escrow and recorded immediately following the release and execution of this Deed. If all such deeds are not recorded within ten days of the recordation of this Deed, the conveyance made herein shall be deemed null and void, and all title and interest to the Property shall revert to the City.

{Signatures appear on the following page}

IN WITNESS WHEREOF, the Grantor has caused this Deed to be executed by its duly authorized representative as of the date first above written:

GRANTOR:

CITY OF RICHMOND, VIRGINIA,
a municipal corporation of the Commonwealth of Virginia

As authorized by Ordinance No. _____, adopted _____, 2016.

By: _____
Selena Cuffee-Glenn,
Chief Administrative Officer

APPROVED AS TO FORM

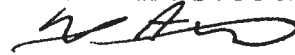

Assistant City Attorney



ACKNOWLEDGMENT

COMMONWEALTH OF VIRGINIA
CITY OF RICHMOND, TO WIT:

I HEREBY CERTIFY, that on this ____ day of _____, 2016 before me, the subscriber, a Notary Public of the State aforesaid, personally appeared Selena Cuffee-Glenn, known to me, or satisfactorily proven to be, the person whose name is subscribed to the within instrument, and who acknowledged to be the Chief Administrative Officer of the City of Richmond, Virginia a municipal corporation of the Commonwealth of Virginia, and acknowledged that execution of the foregoing instrument for the purposes therein contained and acknowledged the same to be the lawful act and deed of the aforesaid corporation.

AS WITNESS my hand and Notarial Seal the day and year first above written.

NOTARY PUBLIC

My Commission Expires: _____
Registration No.: _____

Grantee's Address:
P.O. Box 363
Richmond, VA 23224

Exhibit A
to
City Land Deed

Legal Description

All that land lying and being in the City of Richmond and identified as City Land (Sub-Parcel A-2), containing 1.096 acre, more or less, all as shown on that certain survey entitled "COMPILED EXHIBIT showing SOUTH CANAL DEVELOPMENT," Sheet 1 of 1, Job No. 56160036.00, prepared by Balzer and Associates, and dated June 1, 2016, a copy of which is attached hereto and made a part hereof, and, with reference to such survey, is more particularly described as follows:

COMMENCING at a point at the intersection of the North line of Hull Street, U.S. Route 360, and the East line of Brander Street; thence along a tie line N52°59'35"W, 506.00 feet to a point, said point being the POINT OF BEGINNING; thence N86°13'56"W, 238.82 feet to a point; thence along a curve to the right having a radius of 65.94 feet, an arc length of 35.96 feet, and a chord of N74°59'10"W, 35.51 feet to a point; thence N53°20'46"W, 77.04 feet to a point; thence N51°58'33"W, 31.19 feet to a point; thence along a curve to the right having a radius of 165.00 feet, an arc length of 25.29 feet, and a chord of S88°41'53"E, 25.26 feet to a point; thence S86°37'26"E, 105.29 feet to a point; thence along a curve to the left having a radius of 235.00 feet, an arc length of 138.67 feet, and a chord of N76°28'17"E, 136.67 feet to a point; thence N59°34'00"E, 6.99 feet to a point; thence along a curve to the right with a radius of 265.00 feet, an arc length of 126.30 feet, and a chord of N73°13'14"E, 125.11 feet; thence N86°52'28"E, 203.81 feet to a point; thence along a curve to the left having a radius of 85.00 feet, an arc length of 23.76 feet, and a chord of N78°52'03"E, 23.68 feet to a point; thence N70°51'39"E, 46.85 feet to a point, thence S19°22'57"E, 28.88 feet to a point; thence N71°15'03"E, 116.67 feet to a point; thence S77°00'33"E, 66.53 feet to a point; thence S30°56'37"E, 39.06 feet to a point; thence S12°18'33"W, 4.78 feet to a point; thence N31°41'03"W, 40.44 feet to a point; thence N12°28'53"E, 2.68 feet to a point; thence N77°32'39"W, 68.01 feet to a point; thence S58°37'51"W, 83.63 feet to a point; thence S31°22'09"E, 10.25 feet to a point; thence along a curve to the right having a radius of 105.25, an arc length of 51.09 feet, and a chord of S72°32'09"W, 50.59 feet to a point; thence S86°26'28"W, 156.34 feet to a point; thence along a curve to the Left having a radius of 334.75 feet, an arc length of 115.67 feet, and a chord of S76°32'30"W, 115.10 feet to a point; thence S66°38'31"W, 18.92 feet, thence along a curve to the right having a radius of 385.25 feet, an arc length of 14.12 feet, and a chord of S67°48'36"W, 14.12 feet to a point; thence S03°46'04"W, 79.36 feet to the POINT AND PLACE OF BEGINNING.

BEING a portion of the real estate comprising that certain parcel of land listed in the Office of the City Assessor for the City of Richmond as City Tax Parcel No. S0000052006; such parcel being comprised of the following:

- (1) All that certain real property acquired by GRANTOR from Ross Investment Corporation by that certain Order Directing the Recordation of the Vesting of Title, dated September

29, 1987, recorded on October 6, 1987, in Deed Book 143 at 1265, in the Clerk's Office, Circuit Court, City of Richmond, Virginia ("Clerk's Office"); and

- (2) All that certain real property acquired by GRANTOR from Manchester Board and Paper Company, Inc. by that certain Deed, Deed of Easement, and Deed of Partial Release, dated January 11, 1988, recorded February 11, 1988, in Deed Book 156 at page 897, in the Clerk's Office; and
- (3) All that certain real property acquired by GRANTOR from Manchester Board and Paper Company, Inc. by that certain Deed, Deed of Easement, and Deed of Partial Release, dated January 11, 1988, recorded February 11, 1988, in Deed Book 156 at page 897, in the Clerk's Office; and
- (4) A portion of that certain real property acquired by GRANTOR from Virginia Electric and Power Company by that certain Special Warranty Deed, dated June 9, 1989, recorded June 16, 1989, in Deed Book 205, at page 212 in the Clerk's Office. (Note: The remainder of real property conveyed by such Special Warranty Deed being a portion of that certain adjacent property owned by GRANTOR and listed as City Tax Parcel No. S0000052001.)

* GENERAL PLAN PLAT RECORDS
 FILED FOR RECORDING AND INDEXING 10/14/2013
 FILED FOR RECORDING AND INDEXING 11/14/2013

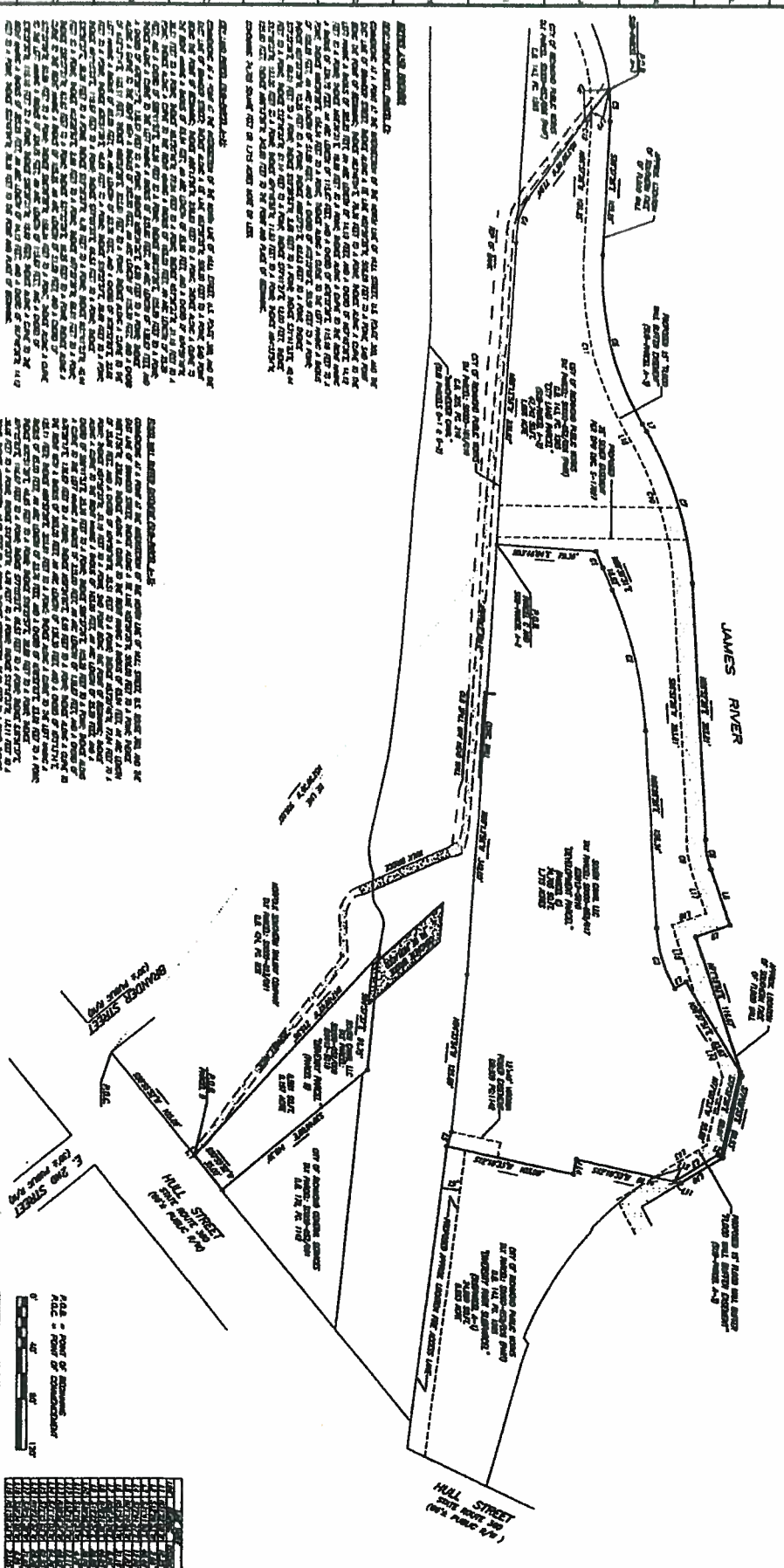

NOTICE: The Engineer has prepared this preliminary plan for the purpose of showing the location and extent of the proposed canal and the location of the proposed streets and the location of the proposed lots. It is not intended to be used for any other purpose. The Engineer is not responsible for any errors or omissions in this plan. The Engineer is not responsible for any damages or liabilities arising from the use of this plan. The Engineer is not responsible for any claims or damages arising from the use of this plan. The Engineer is not responsible for any claims or damages arising from the use of this plan.

SECTION 1.1. THE CITY OF RICHMOND, VIRGINIA, HAS ADOPTED THE FOLLOWING RESOLUTION:

RESOLUTION NO. 111,111, APPROVED AND PASSED BY THE COMMON COUNCIL OF THE CITY OF RICHMOND, VIRGINIA, ON THIS 11TH DAY OF MAY, 2013.

SECTION 1.2. THE CITY OF RICHMOND, VIRGINIA, HAS ADOPTED THE FOLLOWING RESOLUTION:

RESOLUTION NO. 111,112, APPROVED AND PASSED BY THE COMMON COUNCIL OF THE CITY OF RICHMOND, VIRGINIA, ON THIS 11TH DAY OF MAY, 2013.

SECTION 1.3. THE CITY OF RICHMOND, VIRGINIA, HAS ADOPTED THE FOLLOWING RESOLUTION:

RESOLUTION NO. 111,113, APPROVED AND PASSED BY THE COMMON COUNCIL OF THE CITY OF RICHMOND, VIRGINIA, ON THIS 11TH DAY OF MAY, 2013.

SECTION 1.4. THE CITY OF RICHMOND, VIRGINIA, HAS ADOPTED THE FOLLOWING RESOLUTION:

RESOLUTION NO. 111,114, APPROVED AND PASSED BY THE COMMON COUNCIL OF THE CITY OF RICHMOND, VIRGINIA, ON THIS 11TH DAY OF MAY, 2013.

SECTION 1.5. THE CITY OF RICHMOND, VIRGINIA, HAS ADOPTED THE FOLLOWING RESOLUTION:

RESOLUTION NO. 111,115, APPROVED AND PASSED BY THE COMMON COUNCIL OF THE CITY OF RICHMOND, VIRGINIA, ON THIS 11TH DAY OF MAY, 2013.

COMPILED EXHIBIT
 SHOWING
 SOUTH CANAL DEVELOPMENT
 CITY OF RICHMOND, VIRGINIA



Drawn by: [Name]
 Checked by: [Name]
 Date: [Date]
 Scale: 1" = 50'
 Date: 06/14/2016
 User: [Name]

SHEET NO.
 1 of 1
 JOB NO. 111,111



EXHIBIT G
TO
DEVELOPMENT AND COOPERATION AGREEMENT

Storm Water Deed

[Attached Hereto]

EXHIBIT G
to
Development Agreement

AFTER
RECORDING RETURN TO:
City of Richmond, Department of Public Utilities
Attn: C. Scott Yates
City Hall
900 E. Broad Street, Room 115
Richmond, Virginia 232119

CITY OF RICHMOND, VIRGINIA
TAX MAP NO: Part of S0000052006 and
S0000052017

**TAX EXEMPT PER VA CODE SEC. 58.1-811.A.3
DEED OF SEWER AND WATER UTILITY EASEMENT**

THIS AGREEMENT, is made this _____ day of _____, 201__, by
and between **SOUTH CANAL, LLC**, a Virginia limited liability company, its successors
and assigns, hereinafter “**GRANTOR**”, to be indexed as grantor, and the **CITY OF
RICHMOND**, a municipal corporation organized under the laws of the Commonwealth
of Virginia, hereinafter “**GRANTEE**”, to be indexed as grantee.

WITNESSETH:

WHEREAS, by deed dated _____, 201__, recorded on
_____, 20__ as Instrument Number _____ in the Clerk’s Office,
Circuit Court, City of Richmond, Virginia (“Clerk’s Office”) immediately prior to the
recordation of this Deed, GRANTEE conveyed to GRANTOR fee simple title to certain
real property situated in the City of Richmond, Virginia, such property formerly being a
Part of Tax Parcel S0000052006, which property is more particularly described on
Exhibit A attached hereto and made a part hereof as Portion 1, and

WHEREAS, GRANTOR is the fee simple owner of that certain parcel of real
property abutting Portion 1, which parcel is designated as Tax Parcel Number
S0000052017 and more particularly described on **Exhibit A** attached hereto and made a
part hereof as Portion 2 (collectively, Portion 1 and Portion 2 shall be referred to herein
as the “Property”), and

WHEREAS, GRANTEE desires to operate, inspect, maintain, repair, replace, construct, and reconstruct certain storm water lines, and associated appurtenances (collectively the "Facilities") within and under the Property in the location more particularly shown as the area labeled the "Proposed 25' Sewer Easement" on that certain survey entitled "COMPILED EXHIBIT showing SOUTH CANAL DEVELOPMENT," Sheet 1 of 1, Job No. 56160036.00, prepared by Balzer and Associates, certified land surveyor, dated June 1, 2016 (the "Survey") attached hereto and made a part hereof as **Exhibit B** and GRANTOR desires grant and convey to GRANTEE a permanent non-exclusive storm water utility easement (the "Storm Water Utility Easement") for such purposes.

NOW, THEREFORE, in consideration of the sum of Ten Dollars (\$10.00) and other good and valuable consideration, the receipt of which is hereby acknowledged, GRANTOR hereby grants, dedicates, and conveys to GRANTEE, with General Warranty of Title, the Storm Water Utility Easement within, under, above, and across the Storm Water Utility Easement Area for the purposes of operating, inspecting, maintaining, repairing, replacing, constructing, and reconstructing the Facilities.

GRANTOR may use the Storm Water Utility Easement Area for any purpose not inconsistent with the rights hereby granted, provided, however, GRANTOR shall not construct or place any building or permanent structure, or any portion thereof, (a) upon, within, under or above the Storm Water Utility Easement Area, or (b) otherwise upon, within, under or above the Property such as to come within vertical planes measured fifteen (15) horizontal feet from the Facilities, or as otherwise approved by the City of Richmond Department of Public Utilities pursuant to the City of Richmond, Virginia

Department of Public Utilities Sanitary Sewer Design Guidelines and Standard Specifications and Details, dated December 2010, as may be amended from time to time, incorporated and made a part hereof by reference. It is understood by both parties that surface improvements, including landscaping (limited to ground cover, shrubs and small, slow-growing species, varieties and cultivars of trees with non-aggressive root systems, as listed in the pamphlet "Choosing 'Sewer Safer' Trees," published by the Agricultural Extension Service of the University of Tennessee, September 2005 (incorporated and made a part hereof by reference), lighting, hardscape (including concrete, asphalt, bike paths, and walkways), or other utilities and other appurtenances, including fixed benches, small planters, trash receptacles (all collectively referred to as "Surface Improvements"), may be installed by GRANTOR within the Storm Water Utility Easement Area. Provided, however, GRANTOR shall maintain an access area fifteen (15) feet wide at a minimum where a single pipe is located within the Storm Water Utility Easement Area, immediately over the Facilities that is clear of any obstructions that would restrict access by and operation of any GRANTEE's vehicles and equipment, with the exception of removable bollards; and which such access is designed and maintained to support the imposed load of and guarantee passage of GRANTEE's vehicles and associated apparatuses.

GRANTEE hereby covenants and agrees that it will restore portions of the Property (including hardscape improvements as described above) adversely affected during any operation, inspection, maintenance, repair, replacement, construction, or reconstruction of the Facilities to a condition as close as practicable to that condition that existed prior to such operation, inspection, maintenance, repair, replacement, construction

or reconstruction with the exception of Surface Improvements other than hardscape improvements, which will be the responsibility of the GRANTOR, unless otherwise agreed to in writing by the parties hereto or their successors in interest. GRANTEE also covenants and agrees (a) that it will notify GRANTOR 30 days in advance of any routine scheduled maintenance activity for the Facilities, (b) that upon commencing any maintenance, inspection, repair, replacement, construction or reconstruction of the Facilities, GRANTEE will take such commercially reasonable measures as are necessary and safe to allow the continued use of and not otherwise impair the access to and from the Property, and (c) that GRANTEE shall complete any operation, inspection, maintenance, repair, replacement, construction, or reconstruction of the Facilities as expeditiously as reasonably possible.

In the event GRANTOR determines relocating the Facilities is necessary to accommodate GRANTOR's development of the Property, GRANTOR may at its sole cost, sole risk, and in accordance with the terms set forth herein, relocate the Facilities to the area shown striped and labeled "Alternative Storm Water Facilities Location" on Exhibit C attached hereto or to such other area approved in writing by the GRANTEE's Director of Public Utilities (the "Director") (the "Alternative Storm Water Facilities Location"). Unless otherwise approved in writing by the Director, GRANTOR shall connect the Facilities to existing storm water lines at the same location as currently connected and shall "tie-in" to the current penetration of the flood wall in a manner acceptable to the Director and the Army Corps of Engineers. Prior to commencing the relocation of the Facilities, GRANTOR shall provide 60 days written notice of its intention to do so to the Director, shall secure all permits or other approvals required by

applicable law, and shall secure general liability insurance in an amount approved by the Director. GRANTOR's relocation of the Facilities shall comply with all standards set forth by the Army Corps of Engineers and GRANTEE's Department of Public Utilities. Upon relocation of the Facilities, the Storm Water Utility Easement and all other grants and rights herein shall be relocated from the Storm Water Utility Easement Area to the portion of the Alternative Storm Water Facilities Location located on the Property (including the areas on each side of the relocated facilities in a width equal to the width of Storm Water Utility Easement Area on each side of the Facilities) and all terms herein shall apply thereto.

[SIGNATURES BEGIN ON THE FOLLOWING PAGE]

IN WITNESS WHEREOF, GRANTOR has hereunto affixed its signature(s) and seal(s)
as of the day and year first hereinabove written.

GRANTOR:

South Canal, LLC,
a Virginia limited liability company

By: _____

Name: _____

Title: _____

COMMONWEALTH OF VIRGINIA
CITY OF RICHMOND, to-wit:

Subscribed and sworn to before me this ____ day of _____, 2016, by
_____, as _____, of
South Canal, LLC.

Notary Public

My commission expires:

Registration No.:

CITY OF RICHMOND (GRANTEE)

BY: _____

Selena Cuffee-Glenn
Chief Administrative Officer
City of Richmond, Virginia

Approved as to terms:

BY: _____

Approved as to form:

BY:  _____
City Attorney's Office



EXHIBIT A

to
Storm Water Easement

Description of Property

Portion 1:

All that land lying and being in the City of Richmond and identified as City Land (Sub-Parcel A-2), containing 1.096 acres, more or less, all as shown on that certain survey entitled "COMPILED EXHIBIT showing SOUTH CANAL DEVELOPMENT," Sheet 1 of 1, Job No. 56160036.00, prepared by Balzer and Associates, and dated June 1, 2016, a copy of which is attached hereto and made a part hereof, and, with reference to such survey, is more particularly described as follows:

COMMENCING at a point at the intersection of the North line of Hull Street, U.S. Route 360, and the East line of Brander Street; thence along a tie line N52°59'35"W, 506.00 feet to a point, said point being the POINT OF BEGINNING; thence N86°13'56"W, 238.82 feet to a point; thence along a curve to the right having a radius of 65.94 feet, an arc length of 35.96 feet, and a chord of N74°59'10"W, 35.51 feet to a point; thence N53°20'46"W, 77.04 feet to a point; thence N51°58'33"W, 31.19 feet to a point; thence along a curve to the right having a radius of 165.00 feet, an arc length of 25.29 feet, and a chord of S88°41'53"E, 25.26 feet to a point; thence S86°37'26"E, 105.29 feet to a point; thence along a curve to the left having a radius of 235.00 feet, an arc length of 138.67 feet, and a chord of N76°28'17"E, 136.67 feet to a point; thence N59°34'00"E, 6.99 feet to a point; thence along a curve to the right with a radius of 265.00 feet, an arc length of 126.30 feet, and a chord of N73°13'14"E, 125.11 feet; thence N86°52'28"E, 203.81 feet to a point; thence along a curve to the left having a radius of 85.00 feet, an arc length of 23.76 feet, and a chord of N78°52'03"E, 23.68 feet to a point; thence N70°51'39"E, 46.85 feet to a point, thence S19°22'57"E, 28.88 feet to a point; thence N71°15'03"E, 116.67 feet to a point; thence S77°00'33"E, 66.53 feet to a point; thence S30°56'37"E, 39.06 feet to a point; thence S12°18'33"W, 4.78 feet to a point; thence N31°41'03"W, 40.44 feet to a point; thence N12°28'53"E, 2.68 feet to a point; thence N77°32'39"W, 68.01 feet to a point; thence S58°37'51"W, 83.63 feet to a point; thence S31°22'09"E, 10.25 feet to a point; thence along a curve to the right having a radius of 105.25, an arc length of 51.09 feet, and a chord of S72°32'09"W, 50.59 feet to a point; thence S86°26'28"W, 156.34 feet to a point; thence along a curve to the Left having a radius of 334.75 feet, an arc length of 115.67 feet, and a chord of S76°32'30"W, 115.10 feet to a point; thence S66°38'31"W, 18.92 feet, thence along a curve to the right having a radius of 385.25 feet, an arc length of 14.12 feet, and a chord of S67°48'36"W, 14.12 feet to a point; thence S03°46'04"W, 79.36 feet to the POINT AND PLACE OF BEGINNING.

Portion 2:

All that land lying and being in the City of Richmond and identified as Development Parcel (Parcel C), containing 1.715 acres, more or less, all as shown on that certain survey entitled "COMPILED EXHIBIT showing SOUTH CANAL DEVELOPMENT," Sheet 1 of 1, Job No. 56160036.00, prepared by Balzer and Associates, and dated June 1, 2016, a copy of which is attached hereto and made a part hereof, and, with reference to such survey, is more particularly described as follows:

COMMENCING at a point at the intersection of the North line of Hull Street, U.S. Route 360, and the East line of Brander Street; thence along a tie line N52°59'35"W, 506.00 feet to a point, said point being the POINT OF BEGINNING; thence N03°46'04"E, 79.36 feet to a point; thence along a curve to the left having a radius of 385.25 feet, an arc length of 14.12 feet, and a chord of N67°48'36"E, 14.12 feet to point; thence N66°38'31"E, 18.92 feet to a point; thence along a curve to the right having a radius of 334.75 feet, an arc length of 115.67 feet, and a chord of N76°32'30"E, 115.10 feet to a point; thence N86°26'28"E, 156.34 feet to a point; thence along a curve to the left having a radius of 105.25 feet, an arc length of 51.09

feet, and a chord N72°32'09"E, 50.59 feet to a point; thence N31°22'09"W, 10.25 feet to a point; thence N58°37'51"E, 83.63 feet to a point; thence S77°32'39"E, 68.01 feet to a point; thence S12°28'53"W, 2.68 feet to a point; thence S31°41'03"E, 40.44 feet to a point; thence S12°18'33"W, 81.14 feet to a point; thence S77°41'27"E, 12.00 feet; thence S12°18'33"W, 103.00 feet to a point; thence N71°10'55"W, 11.83 feet to a point; thence N84°33'54"W, 125.60 feet; thence N86°13'56"W, 342.00 feet to the POINT AND PLACE OF BEGINNING.

BEING a portion of the real property acquired by South Canal, LLC, from Fountainhead Acquisitions, LLC, by that certain Deed of Contribution, dated March 13, 2012, and recorded March 16, 2012, in the Clerk's Office, Circuit Court, City of Richmond, Virginia, as Instrument Number 12-5010.

EXHIBIT B
to
Storm Water Easement

Survey

(See Following Page)



* BOUNDARY AND CORNER MARKS
 AS SHOWN ON PLAT OF 11/17/2012
 FILED FOR RECORD IN BOOK 111 AND 112 PAGE 108

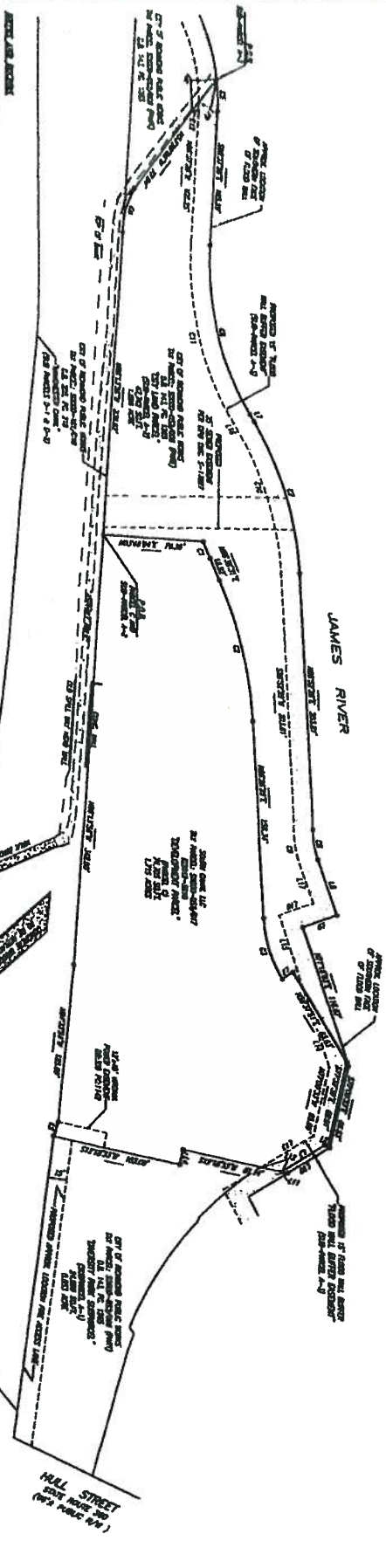

NOTE: THIS PLAN HAS BEEN PREPARED FROM INFORMATION OF RECORDS AND FIELD SURVEY AND IS NOT A GUARANTEE OF ACCURACY. THE ENGINEER HAS CONDUCTED A VISUAL GENERAL VERIFICATION OF THE INFORMATION PROVIDED AND HAS FOUND IT TO BE REASONABLY CORRECT. THE ENGINEER HAS NOT CONDUCTED A SURVEY OF THE PROPERTY AND HAS NOT BEEN ADVISED OF ANY CHANGES TO THE PROPERTY SINCE THE DATE OF THE SURVEY. THE ENGINEER HAS NOT CONDUCTED A SURVEY OF THE PROPERTY AND HAS NOT BEEN ADVISED OF ANY CHANGES TO THE PROPERTY SINCE THE DATE OF THE SURVEY. THE ENGINEER HAS NOT CONDUCTED A SURVEY OF THE PROPERTY AND HAS NOT BEEN ADVISED OF ANY CHANGES TO THE PROPERTY SINCE THE DATE OF THE SURVEY.

THE ENGINEER HAS CONDUCTED A VISUAL GENERAL VERIFICATION OF THE INFORMATION PROVIDED AND HAS FOUND IT TO BE REASONABLY CORRECT. THE ENGINEER HAS NOT CONDUCTED A SURVEY OF THE PROPERTY AND HAS NOT BEEN ADVISED OF ANY CHANGES TO THE PROPERTY SINCE THE DATE OF THE SURVEY. THE ENGINEER HAS NOT CONDUCTED A SURVEY OF THE PROPERTY AND HAS NOT BEEN ADVISED OF ANY CHANGES TO THE PROPERTY SINCE THE DATE OF THE SURVEY.

THE ENGINEER HAS CONDUCTED A VISUAL GENERAL VERIFICATION OF THE INFORMATION PROVIDED AND HAS FOUND IT TO BE REASONABLY CORRECT. THE ENGINEER HAS NOT CONDUCTED A SURVEY OF THE PROPERTY AND HAS NOT BEEN ADVISED OF ANY CHANGES TO THE PROPERTY SINCE THE DATE OF THE SURVEY. THE ENGINEER HAS NOT CONDUCTED A SURVEY OF THE PROPERTY AND HAS NOT BEEN ADVISED OF ANY CHANGES TO THE PROPERTY SINCE THE DATE OF THE SURVEY.

THE ENGINEER HAS CONDUCTED A VISUAL GENERAL VERIFICATION OF THE INFORMATION PROVIDED AND HAS FOUND IT TO BE REASONABLY CORRECT. THE ENGINEER HAS NOT CONDUCTED A SURVEY OF THE PROPERTY AND HAS NOT BEEN ADVISED OF ANY CHANGES TO THE PROPERTY SINCE THE DATE OF THE SURVEY. THE ENGINEER HAS NOT CONDUCTED A SURVEY OF THE PROPERTY AND HAS NOT BEEN ADVISED OF ANY CHANGES TO THE PROPERTY SINCE THE DATE OF THE SURVEY.

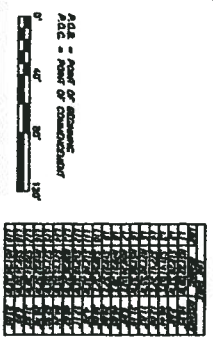

COMPILED EXHIBIT
 SHOWING
 SOUTH CANAL DEVELOPMENT
 CITY OF RICHMOND, VIRGINIA



1521 Old New Drive
 Suite 202
 Richmond, VA 23113
 804-784-0271
 FAX 804-784-0265

SHEET NO.
 1 of 1
 DATE: 01/17/2012
 SCALE: 1" = 40'

EXHIBIT C
to
Storm Water Easement

Alternative Storm Water Facilities Location

(See Following Page)

EXISTING BOUNDARY, TOPOGRAPHY AND EASEMENT
LOCATIONS WERE PERFORMED BY OTHERS AND PROVIDED BY
CLIENT

NOTE THAT THE FOUNDATION IS SUPPORTED BY
PILING AND IS NOT TO BE
REMOVED. THE FOUNDATION IS
TO BE REINFORCED WITH
STEEL REBAR AND CONCRETE
TO BE PLACED OVER THE
EXISTING FOUNDATION.

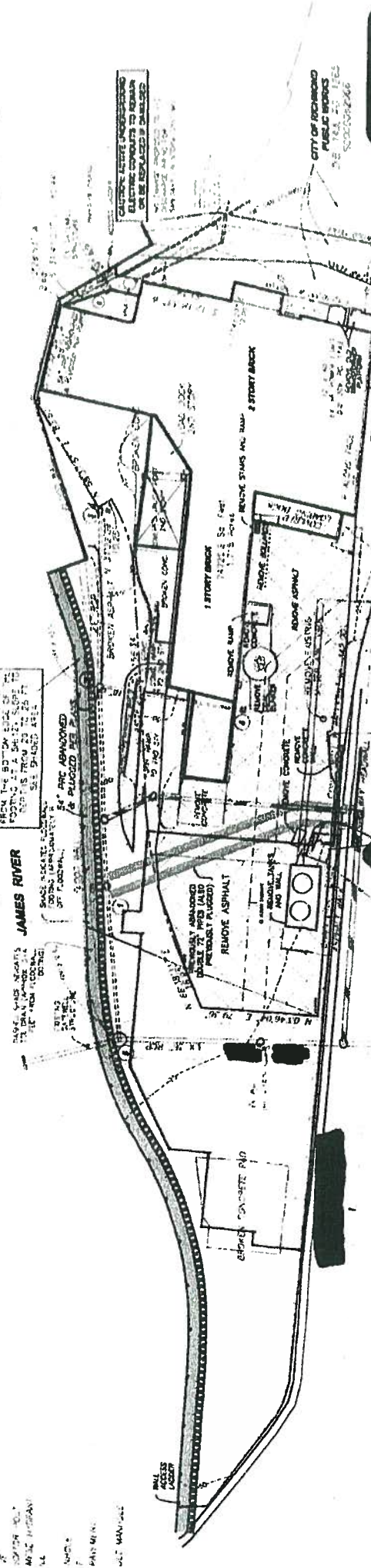

EXHIBIT
C
TO STORM WATER FACILITY

ALTERNATIVE
STORM WATER
FACILITY'S LOCATION

GRAPHIC SCALE
1 inch = 40 feet

WORFOLK SOUTHERN RAIL
CLIP 414, 42, 43, 44
5200022201

REMOVE PAVING TO ACCOMMODATE TRAFFIC APPROXIMATELY 5' WIDE

9	Height	1.00	Drop Inlet	Top	3.20	Height	3.20
8	Top	3.20	6 Foot	3.10	24" Cliff RCP @	0.0% slope	
7	Top	3.10	10 Foot	5.00	Inlet	5.76	

DATE: 01/11/05
DRAWN BY: J. J. JONES

PROJECT: STORM WATER FACILITY
LOCATION: 1000 S. 10TH ST.
CITY: RICHMOND, VA

SCALE: 1/4" = 1'-0"
DATE: 01/11/05

MANCHESTER CANAL
CITY OF RICHMOND
GENERAL SERVICE

BAINBRIDGE ST.
30% PUBLIC ROW

E. 2ND ST.
30% PUBLIC ROW

LESLIE ST.
30% PUBLIC ROW

CITY OF RICHMOND
PUBLIC WORKS
1000 S. 10TH ST.
RICHMOND, VA 23219-2446

EXISTING FOUNDATION TO REMAIN
OR BE REPLACED BY CONCRETE

EXHIBIT H
TO
DEVELOPMENT AND COOPERATION AGREEMENT

Right-of-Entry Agreement

[Attached Hereto]

**Exhibit H
to
Development Agreement**

RIGHT-OF-ENTRY AGREEMENT

THIS RIGHT OF ENTRY AGREEMENT is made this ___ day of _____, 201___, between the City of Richmond, a municipal corporation and political subdivision of the Commonwealth of Virginia (the "City"), and South Canal, LLC, a Virginia Limited Liability Company ("South Canal").

RECITALS

- A. The City and South Canal entered into that certain Development and Cooperation Agreement dated _____, 20___ (the "Development Agreement"), which is attached hereto and made a part hereof.
- B. The Development Agreement requires South Canal to (1) demolish the Old Bridge, (2) construct the Replacement Bridge in accordance with the approved Final Bridge Plans, and (3) construct the Fire and Safety Lane in accordance with the Fire and Safety Lane Plans (the "Obligations").
- C. The performance of the Obligations requires South Canal and its agents, contractors, employees, invitees, licensees, officers, and volunteers to enter onto certain portions of the Canal Parcel and Diversity Park, both owned by the City, and the City is willing to grant the right to enter such property to South Canal for the sole purpose of performing the Obligations upon and subject to the terms and conditions contained herein.

AGREEMENT

The City and South Canal, intending to be legally bound, agree as follows:

1.0 Scope.

1.1 Defined Terms. For purposes of this Right of Entry Agreement, terms defined in the Development Agreement shall have the meaning prescribed to them in the Development Agreement unless specifically defined otherwise in this Right of Entry Agreement.

1.1.1 Meaning of "Property." For the purposes of this Right of Entry Agreement, "Property" means those portions of the Canal Parcel and Diversity Park, both as described in the Development Agreement, to which access is reasonably necessary to complete the Obligations.

1.1.2 Meaning of "Obligations" For purposes of Agreement, "Obligations" means the activities conducted by South Canal described in section 2.1 of this Right of Entry Agreement.

Exhibit H

to

Development Agreement

- 1.2 Grant of Right of Entry.** Subject to the terms and conditions of this Right of Entry Agreement, including but not limited to the permit, insurance, and surety requirements prescribed herein, the City hereby grants to South Canal, and its agents, contractors, employees, invitees, licensees, officers, and volunteers, the non-exclusive right to enter upon the Property for the sole purpose of performing the Services. The right to enter is conditioned upon South Canal's compliance with the terms and conditions of this Right of Entry Agreement. South Canal shall vacate the Property within ten days of receiving notice from the City of South Canal's failure to comply with the terms and conditions of this Right of Entry; provided, however, that South Canal shall not be required to vacate if South Canal cures such failure within such ten days.
- 1.2 Duration of Right of Entry.** The Agreement, including the right to enter granted herein, shall terminate automatically upon the earlier of (i) the completion of the Services as determined by the City in its reasonable discretion or (ii) the termination by the City or South Canal of the Development Agreement in accordance with the terms and conditions therein.
- 1.3 No Relationship between Parties.** The City and South Canal agree that South Canal is an independent entity and in no way to be considered an employee, partner, agent, or associate, whether by joint venture or otherwise, of the City in the conduct of its business and the performance of the Services.
- 2.0 Standards and Requirements.**
- 2.1 Obligations.** South Canal, at its cost and in accordance with the terms of this Right of Entry Agreement, the Development Agreement, and all applicable laws, shall demolish the Old Bridge, construct the Replacement Bridge in accordance with the approved Final Bridge Plans, and construct the Fire and Safety Lane in accordance with the Fire and Safety Lane Plans.
- 2.1.2 Performance of Services.** South Canal shall complete the Obligations within the timeframe set forth in the Development Agreement. South Canal acknowledges that if South Canal commences the Obligations and does not complete the Obligations within the timeframe set forth in the Development Agreement, the City will be damaged and the non-completion of commenced Obligations may render the City in a worse position than had no portion of the Obligations been performed.
- 2.2 Permits.** Prior to commencing the Obligations or any applicable portion thereof, South Canal shall obtain all permits and approvals required by the City, the United States Army Corps of Engineers, and any other applicable agency.
- 2.3 Trees.** South Canal shall not remove nor damage any trees on the Property without the prior written consent of the City Arborist. South Canal shall replace any trees removed or damaged in a manner deemed sufficient by the City Arborist in his reasonable discretion.

Exhibit H

to

Development Agreement

- 2.4 **Repairs.** With the exception of demolition the Old Bridge, South Canal shall not remove nor damage any improvements on the Property, including but not limited to the wooden fence thereon, without the prior written consent of the City. South Canal shall repair any damage caused to the Property, including the improvements thereon, in the performance of the Services to the satisfaction of the City as determined by the City in its reasonable discretion. If South Canal has not done so by the termination of this Agreement, the City may make any necessary repairs at South Canal's cost. This section shall survive the termination of this Agreement.
- 2.5 **Utility Protection.** South Canal shall protect all private and publicly owned utilities located within the Property or otherwise affected by South Canal's performance of the Obligations and shall not permit any utilities interruption.
- 2.5 **Trees; Fence.** With the exception of demolition the Old Bridge, South Canal shall not remove nor damage any improvements on the Property, including but not limited to the wooden fence thereon, without the prior written consent of the City. South Canal shall replace or repair, as applicable, any improvements removed or damaged in a manner deemed sufficient by the City's Director of Planning and Development Review.
- 3.0 **Liability.**
- 3.1 **Release.** The City shall not be liable for any personal injury or property damage to South Canal, its agents, contractors, employees, invitees, licensees, officers, or volunteers, irrespective of how the injury or damage is caused, and South Canal hereby releases the City from any liability, real or alleged, for any personal injury or property damage to South Canal, as well as its agents, contractors, employees, invitees, licensees, officers, or volunteers irrespective of how the injury or damage is caused. Nothing herein shall be construed as a waiver of the sovereign immunity granted to the City by the Commonwealth of Virginia statutes and case law to the extent that it applies. This section shall survive the termination of this Right of Entry Agreement.
- 3.2 **Indemnity.** South Canal shall indemnify and defend the City and its agents, contractors, employees, officers, and volunteers from and against any and all losses, liabilities, claims, damages and expenses, including court costs and reasonable attorneys' fees, caused by, resulting from, or arising out of any claim, action, or other proceeding, including any claim, action or other proceeding initiated or maintained by any of South Canal's agents, contractors, employees, invitees, licensees, officers, or volunteers, that is based on or related to (i) the South Canal's breach of this Agreement, (ii) the use of the Property by South Canal, as well as its agents, contractors, employees, invitees, licensees, officers, or volunteers, (iii) the performance of any Services on or outside of the Property by South Canal or its agents, contractors, employees, invitees, licensees, officers, or volunteers, (iv) the presence on or about the Property by its agents, contractors, employees, invitees, licensees, officers, or volunteers, (v) the conduct or actions of South Canal or its agents, contractors, employees, invitees, licensees, officers, or volunteers within or outside the scope of this Right of Entry Agreement, or (vi) any error, omission, negligent act or intentional act of South Canal or its agents, contractors, employees, invitees, licensees,

Exhibit H

to

Development Agreement

officers, or volunteers. This section shall survive the termination of this Right of Entry Agreement.

3.3 Insurance. South Canal shall ensure that commercial general liability insurance with a combined limit of not less than \$2,000,000 per occurrence, insuring South Canal and any of its agents, contractors, employees, invitees, licensees, officers, or volunteers performing Services on behalf of South Canal against liability for injury to persons and damage to property occurring on or about the Property or arising out of use thereof or the Services performed thereon, with an insurer licensed to transact insurance business in the Commonwealth of Virginia, is maintained throughout the duration of this Agreement. The insurance policy or policies under which the required insurance is provided shall include the City as an additional insured and shall be effective before South Canal or its agents, contractors, employees, invitees, licensees, officers, or volunteers enter the Property. South Canal shall furnish the City with copies of the required additional insured endorsements and such certificates of insurance evidencing the existence of the required insurance coverage as the City may request, and neither South Canal nor its agents, contractors, employees, invitees, licensees, officers, or volunteers shall enter the Property until the City's Chief of Risk Management has approved the required insurance.

4.0 Miscellaneous.

4.1 Assignment. South Canal shall not transfer or assign its rights or obligations under this Right of Entry Agreement.

4.2 Dispute Resolution.

4.2.1 Construction and Interpretation. Each of the parties has had the opportunity to have its legal counsel review this Right of Entry Agreement on its behalf. If an ambiguity or question of intent arises with respect to any provision of this Right of Entry Agreement, this Right of Entry Agreement will be construed as if drafted jointly by the parties. Neither the form of this Right of Entry Agreement, nor any language herein, shall be construed or interpreted in favor of or against either party hereto as the sole drafter thereof.

4.2.2 Forum and Venue. Any and all disputes, claims and causes of action arising out of or in connection with this Right of Entry Agreement, or any performances made hereunder, shall be brought, and any judicial proceeding shall take place, only in the Circuit Court of the City of Richmond, Virginia.

4.2.3 Governing Law. All issues and questions concerning the construction, enforcement, interpretation and validity of this Right of Entry Agreement, or the rights and obligations of the City and South Canal in connection with this Right of Entry Agreement, shall be governed by, and construed and interpreted in accordance with, the laws of the Commonwealth of Virginia, without giving effect to any choice of laws or conflict of laws rules or provisions, whether of the Commonwealth of Virginia or any other jurisdiction,

Exhibit H
to
Development Agreement

that would cause the application of the laws of any jurisdiction other than those of the Commonwealth of Virginia.

4.3 **Modifications.** This Right of Entry Agreement contains the complete understanding and agreement of the parties with respect to the matters covered herein and may not be modified except in a written instrument signed by the duly authorized representatives of each of the parties hereto.

4.4 **No Third-Party Beneficiaries.** Notwithstanding any other provision of this Right of Entry Agreement, the City and South Canal hereby agree that: (i) no individual or entity shall be considered, deemed or otherwise recognized to be a third-party beneficiary of this Right of Entry Agreement; (ii) the provisions of this Right of Entry Agreement are not intended to be for the benefit of any individual or entity other than the City and South Canal; (iii) no individual or entity shall obtain any right to make any claim against the City or South Canal under the provisions of this Right of Entry Agreement; and (iv) no provision of this Right of Entry Agreement shall be construed or interpreted to confer third-party beneficiary status on any individual or entity. For purposes of this section, the phrase "individual or entity" means any individual or entity, including, but not limited to, individuals, contractors, subcontractors, vendors, sub-vendors, assignees, licensors and sub-licensors, regardless of whether that individual or entity is named in this Right of Entry Agreement.

4.5 **Notices.** All notices, offers, consents, or other communications required or permitted to be given pursuant to this Right of Entry Agreement shall be in writing and shall be considered as properly given or made if delivered personally, by messenger, by recognized overnight courier service or by registered or certified U. S. mail with return receipt requested, and addressed to the address of the intended recipient at the following addresses:

A. To South Canal:

7 East 2nd Street
Richmond, Virginia 23224
Attn: Chris Dillon
804-513-4990

B. To the City:

Chief Administrative Officer
900 East Broad Street, Suite 201
Richmond, Virginia 23219

With a copy to:

**Exhibit H
to
Development Agreement**

Either party may change any of its address information given above by giving notice in writing stating its new address to the other party.

4.6 **Signature Authority.** The Chief Administrative Officer for the City of Richmond or her designee shall have the authority to provide any notices or authorizations contemplated in this Agreement on behalf of the City.

Effective as of the date it is released from escrow in accordance with the Escrow Agreement.

**DEVELOPER
SOUTH CANAL, LLC:**

CITY:

By: _____
Richard W. Gregory
Authorized Representative

By: _____
Selena Cuffee-Glenn
Chief Administrative Officer

Authorized by Ord. No. _____,
adopted _____, _____.

APPROVED AS TO TERMS:

Date

APPROVED AS TO FORM:



City Attorney's Office

09-21-2016

Date



**EXHIBIT I
TO
DEVELOPMENT AND COOPERATION AGREEMENT**

Escrow Agreement

[Attached Hereto]

EXHIBIT I
to
Development Agreement

ESCROW AGREEMENT

This ESCROW AGREEMENT, made this ___ day of _____, 2016 by and among The **CITY OF RICHMOND**, a municipal corporation of the Commonwealth of Virginia (the "City"), **SOUTH CANAL, LLC**, a Virginia limited liability company ("South Canal"), and _____, a _____ ("Escrow Agent") recites and provides as follows:

Recitals:

- A. The City and South Canal entered into that certain Development and Cooperation Agreement, dated _____ ("Development Agreement") with respect to the development of various parcels of real property all as more particularly described therein, a copy of which has been provided to the Escrow Agent.

- B. The Development Agreement contemplates the parties entering into various related agreements and deeds (the "Transaction Documents") and further specifies that once executed such documents will be held in escrow by the Escrow Agent to be released, delivered, and, except for the Right-of-Entry Agreement, recorded by the Escrow Agent pursuant to the terms and conditions contained herein.

Agreement:

Now therefore, for and consideration of one dollar (\$1.00) and other good and valuable consideration, the receipt and sufficiency of which are hereby acknowledged, the parties hereto agree as follows:

- 1. **Recitals.** The above recitals are incorporated herein by reference.

- 2. **Definitions.** All capitalized terms not defined herein shall have the same definition as set forth in the Development Agreement.

- 3. **Escrow Agent.** Escrow Agent shall at all times comply with the Applicable Laws in its performance of this Escrow Agreement. Escrow Agent, the City, and South Canal agree that Escrow Agent shall not be deemed to be a party to the Development Agreement or any of the Transaction Documents.

4. Acceptance of fully executed Transaction Documents. Escrow Agent acknowledges receipt of fully executed and notarized originals suitable for recording, as applicable, in the Clerk's Office of the Circuit Court for the City of Richmond, Virginia (the "Clerk's Office"), each of the Transaction Documents listed on **Exhibit "A"** attached hereto.
5. Blanks on Transaction Documents. Prior to release, delivery, and recordation of any Transaction Document, Escrow Agent agrees to fill in the dates, blanks, and missing information in the Transaction Documents, provided that the City and South Canal have first been notified in writing of such action and approve such action in writing.
6. Release and Recordation of Transaction Documents. Escrow Agent agrees to hold each of the Transaction Documents in escrow and to release, record (with the exception of the Right-of-Entry), and deliver each Transaction Document in accordance with the following:
 - a. Right of Entry. The Right of Entry Agreement is necessary for the construction of the Replacement Bridge and Fire Safety Lane and shall be released and delivered to South Canal upon Escrow Agent receiving confirmation of the City's approval of Final Bridge Plans and the Fire and Safety Lane location.
 - b. City Land Deed. The City Land Deed shall be released and recorded upon Escrow Agent receiving written confirmation of the South Canal's completion and the City's acceptance of the Replacement Bridge and the Fire and Safety Lane. Following recordation, the Escrow Agent shall deliver the original recorded City Land Deed to South Canal and a copy thereof to the City.
 - c. Driveway Deed, Canal Parcel Deed and City Access Easement. The Driveway Deed, Canal Parcel and Flood Wall Parcel Quitclaim Deed, Storm Water Easement, and City Flood Wall Buffer and Access Agreement and Deed of Easements shall each be released and recorded immediately following the release and recordation of the City Land Deed. Following recordation, the Escrow Agent shall deliver each of the original recorded Driveway Deed, Canal Parcel and Flood Wall Parcel Quitclaim Deed, Storm Water Easement, and City Flood Wall Buffer and Access Agreement and Deed of Easements to the City and a copy of each to South Canal.
7. Recording Fees. Any recording taxes and fees necessary to record the Transaction Documents shall be paid by South Canal.

8. Termination. This agreement shall terminate upon the earlier of (a) the release, recordation, and delivery of the all Transaction Documents in accordance with the Development Agreement and Section 5 herein or (b) the termination of the Development Agreement pursuant to the terms therein and Escrow Agent marking the Transaction Documents null and void as provided herein. If Escrow Agent receives written notice from the City or South Canal that the Development Agreement has terminated prior to the release, recordation, and delivery of all the Transaction Documents, Escrow Agent shall notify the other party. Upon confirmation from such other party or lack of objection from such other party within ten (10) days of notice, thereto, Escrow Agent shall clearly mark each page of each Transaction Document "NULL AND VOID" and shall return such documents to the City.

9. Miscellaneous. This agreement shall inure to the benefit of and shall be binding upon the parties hereto and their respective heirs, successors and permitted assigns. It shall be construed and enforced in accordance with the laws of the Commonwealth of Virginia and all amendments hereto shall be in writing and signed by all parties hereto.

Witness the following signatures,

CITY OF RICHMOND,
 a municipal corporation of the Commonwealth of Virginia

By: _____
 Selena Cuffee-Glenn, CAO

APPROVED AS TO FORM



 Assistant City Attorney

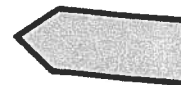

SOUTH CANAL, LLC,
 a Virginia limited liability company

By: _____
 Title: _____

ESCROW AGENT
 _____, a _____

By: _____
 Title: _____

Exhibit A
to
Escrow Agreement

Transaction Documents

- 1. Right-of-Entry Agreement (Exhibit H to the Development Agreement)**
- 2. City Land Deed (Exhibit F to the Development Agreement)**
- 3. City Flood Wall Buffer and Access Agreement and Deed of Easements (Exhibit C to the Development Agreement)**
- 4. Canal Parcel and Flood Wall Parcel Quitclaim Deed (Exhibit E to the Development Agreement)**
- 5. Storm Water Easement (Exhibit G to the Development Agreement)**
- 6. Driveway Deed (Exhibit D to the Development Agreement)**

EXHIBIT J
TO
DEVELOPMENT AND COOPERATION AGREEMENT

Bridge Requirements and Conceptual Plans

A. Bridge Requirements. South Canal shall construct the Replacement Bridge in accordance with the following:

1. AASHTO LRFD Bridge Design Specifications, Customary U.S. Units, 7th Edition.
2. VDOT Highway and Bridge Standards.
3. VDOT Instructional and Informational Manual S&B I&IM 86.
4. VDOT guidelines for applicable material acceptance and testing for locally administered projects.
5. HL – 93
6. Fire Truck Capacity standards shown on Exhibit J-2.
7. Minimum Specifications:
 - 25' width between curbs – two lanes and two shoulders.
 - 5' sidewalk with railing.
 - Street lighting.

B. Conceptual Plans. If such plans meet the Bridge Requirements set forth herein as determined by DPW and unless otherwise approved by DPW, South Canal shall build the Replacement Bridge using precast concrete construction with a single span design as generally shown on the conceptual plans attached hereto as Exhibit J-1.

C. Precedence. To the extent there is any discrepancy between the Bridge Requirements set forth herein and the Conceptual Plans, the Bridge Requirements shall take precedence.

EXHIBIT
J-1
 To DEIA AGREEMENT

COASTAL PRECAST SYSTEMS
 1000 Highway 101, Suite 100, San Marcos, CA 92069
 (760) 734-1100

FOURMILE ROAD PROJECTS
 SOUTH CANAL PROJECT, BIRMINGHAM, AL
 SECTION PLAN

DATE: 12/15/10
 DRAWN BY: J. B. [unclear]
 CHECKED BY: [unclear]
 SCALE: 1" = 10'-0"

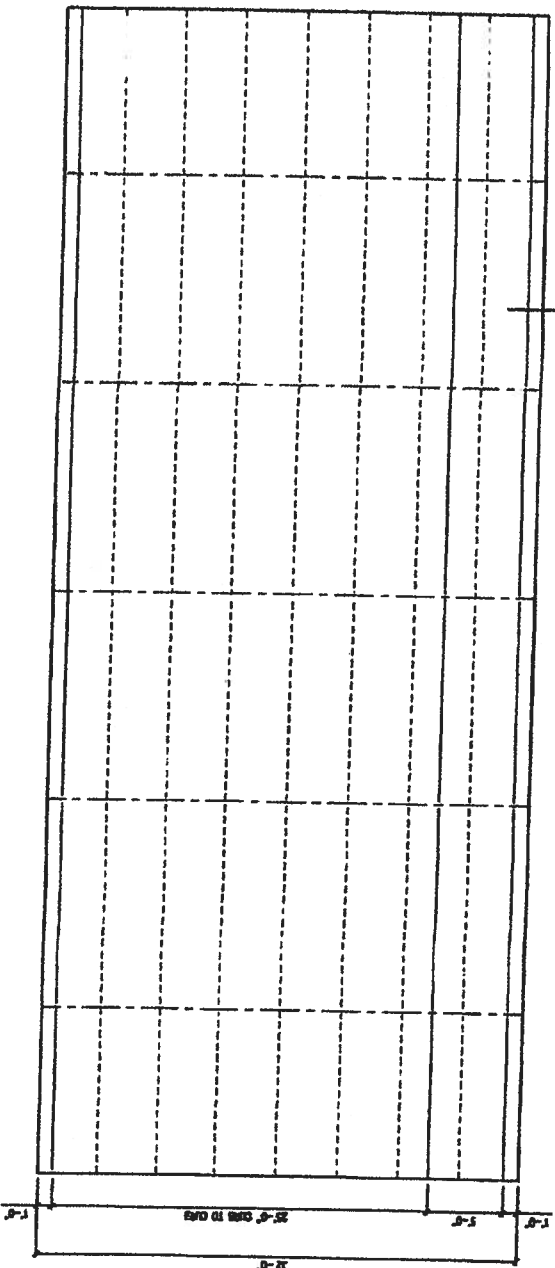

PLAN VIEW

TYPICAL SECTION

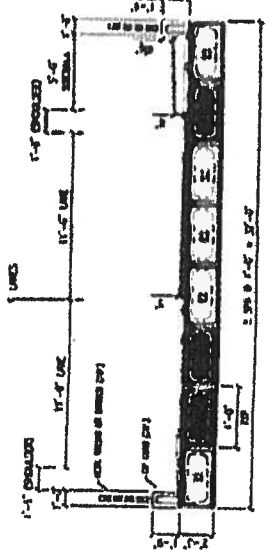

1 SECTION

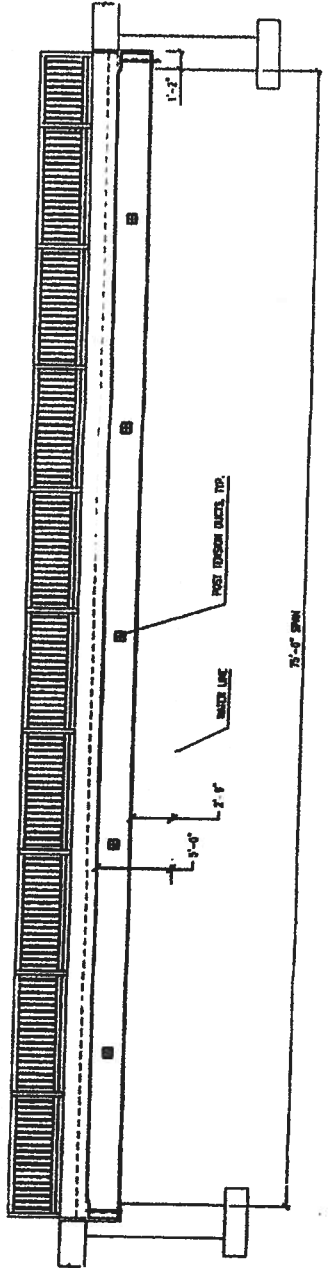

PRECAST CONCRETE PANEL TYPE

WALKWAY LINE

25'-0\"/>

[Home](#)[ICC Home](#)[Contact Us](#)[Help](#)[Shop](#)

ICC publicACCESS

[Home](#) > [2012 VA Fire Prevention Code](#)

2012 VA Fire Prevention Code

[Table of Contents](#)

Chapter Selector



APPENDIX D FIRE APPARATUS ACCESS ROADS

DHCD Note: The provisions of this appendix are not part of this code and are provided only as a resource for local governments in consideration of the adoption of local fire prevention regulations.

SECTION D101 GENERAL

D101.1 Scope.

Fire apparatus access roads shall be in accordance with this appendix and all other applicable requirements of the *International Fire Code*.

SECTION D102 REQUIRED ACCESS

D102.1 Access and loading.

Facilities, buildings or portions of buildings hereafter constructed shall be accessible to fire department apparatus by way of an *approved* fire apparatus access road with an asphalt, concrete or other *approved* driving surface capable of supporting the imposed load of fire apparatus weighing at least 75,000 pounds (34 050 kg).

SECTION D103 MINIMUM SPECIFICATIONS

D103.1 Access road width with a hydrant.

[BACK TO TOP](#)

Where a fire hydrant is located on a fire apparatus access road, the minimum road width shall be 26 feet (7925 mm), exclusive of shoulders (see Figure D103.1).

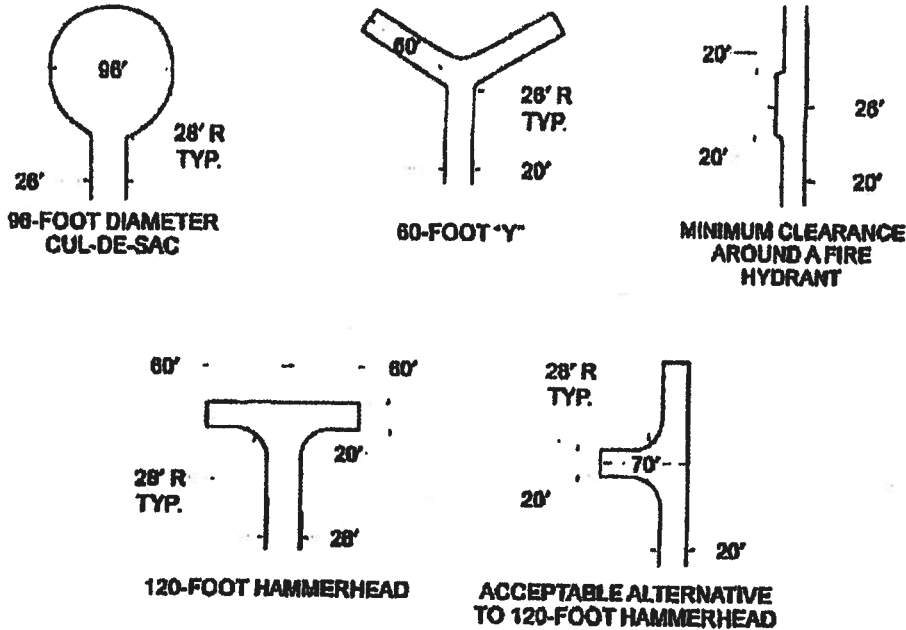

For SI: 1 foot = 304.8 mm.

FIGURE D103.1 DEAD-END FIRE APPARATUS ACCESS ROAD TURNAROUND

D103.2 Grade.

Fire apparatus access roads shall not exceed 10 percent in grade.

Exception: Grades steeper than 10 percent as *approved* by the fire chief.

D103.3 Turning radius.

The minimum turning radius shall be determined by the *fire code official*.

D103.4 Dead ends.

Dead-end fire apparatus access roads in excess of 150 feet (45 720 mm) shall be provided with width and turnaround provisions in accordance with Table D103.4.

TABLE D103.4 REQUIREMENTS FOR DEAD-END FIRE

APPARATUS ACCESS ROADS

LENGTH (feet)	WIDTH (feet)	TURNAROUNDS REQUIRED
0-150	20	None required
161-500	20	120-foot Hammerhead, 60-foot "Y" or 98-foot diameter cul-de-sac in accordance with Figure D103.1
501-750	26	120-foot Hammerhead, 60-foot "Y" or 98-foot diameter cul-de-sac in accordance with Figure D103.1
Over 750		Special approval required

For SI: 1 foot = 304.8 mm.

D103.5 Fire apparatus access road gates.

Gates securing the fire apparatus access roads shall comply with all of the following criteria:

1. The minimum gate width shall be 20 feet (6096 mm).
2. Gates shall be of the swinging or sliding type.
3. Construction of gates shall be of materials that allow manual operation by one person.
4. Gate components shall be maintained in an operative condition at all times and replaced or repaired when defective.
5. Electric gates shall be equipped with a means of opening the gate by fire department personnel for emergency access. Emergency opening devices shall be approved by the fire code official.
6. Manual opening gates shall not be locked with a padlock or chain and padlock unless they are capable of being opened by means of forcible entry tools or when a key box containing the key(s) to the lock is installed at the gate location.
7. Locking device specifications shall be submitted for approval by the fire code official.
8. Electric gate operators, where provided, shall be listed in accordance with UL 325.
9. Gates intended for automatic operation shall be designed, constructed and installed to comply with the requirements of ASTM F

2200.

D103.6 Signs. Where required by the *fire code official*, fire apparatus access roads shall be marked with permanent NO PARKING—FIRE LANE signs complying with Figure D103.6. Signs shall have a minimum dimension of 12 inches (305 mm) wide by 18 inches (457 mm) high and have red letters on a white reflective background. Signs shall be posted on one or both sides of the fire apparatus road as required by Section D103.6.1 or D103.6.2.

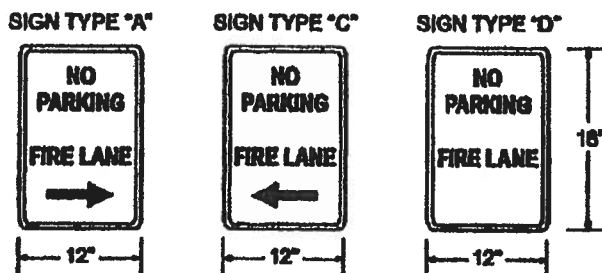

FIGURE D103.6 FIRE LANE SIGNS

D103.6.1 Roads 20 to 26 feet in width.

Fire lane signs as specified in Section D103.6 shall be posted on both sides of fire apparatus access roads that are 20 to 26 feet wide (6096 to 7925 mm).

D103.6.2 Roads more than 26 feet in width.

Fire lane signs as specified in Section D103.6 shall be posted on one side of fire apparatus access roads more than 26 feet wide (7925 mm) and less than 32 feet wide (9754 mm).

SECTION D104 COMMERCIAL AND INDUSTRIAL DEVELOPMENTS

D104.1 Buildings exceeding three stories or 30 feet in height.

Buildings or facilities exceeding 30 feet (9144 mm) or three stories in height shall have at least two means of fire apparatus access for each structure.

D104.2 Buildings exceeding 62,000 square feet in area.

Buildings or facilities having a gross *building area* of more than 62,000 square feet (5760 m²) shall be provided with two separate and *approved* fire apparatus access roads.

Exception: Projects having a gross *building area* of up to 124,000 square feet (11 520 m²) that have a single *approved* fire apparatus access road when all buildings are equipped throughout with *approved automatic sprinkler systems*.

D104.3 Remoteness.

Where two fire apparatus access roads are required, they shall be placed a distance apart equal to not less than one half of the length of the maximum overall diagonal dimension of the lot or area to be served, measured in a straight line between accesses.

SECTION D105 AERIAL FIRE APPARATUS ACCESS ROADS

D105.1 Where required.

Where the vertical distance between the grade plane and the highest roof surface exceeds 30 feet (9144 mm), approved aerial fire apparatus access roads shall be provided. For purposes of this section, the highest roof surface shall be determined by measurement to the eave of a pitched roof, the intersection of the roof to the exterior wall, or the top of parapet walls, whichever is greater.

D105.2 Width.

Aerial fire apparatus access roads shall have a minimum unobstructed width of 26 feet (7925 mm), exclusive of shoulders, in the immediate vicinity of the building or portion thereof.

D105.3 Proximity to building.

At least one of the required access routes meeting this condition shall be located within a minimum of 15 feet (4572 mm) and a maximum of 30 feet (9144 mm) from the building, and shall be positioned parallel to one entire side of the building. The side of the building on which the aerial fire apparatus access road is positioned shall be approved by the *fire code official*.

D105.4 Obstructions.

Overhead utility and power lines shall not be located over the aerial fire apparatus access road or between the aerial fire apparatus road and the building. Other obstructions shall be permitted to be placed with the approval of the *fire code official*.

SECTION D106 MULTIPLE-FAMILY RESIDENTIAL DEVELOPMENTS

D106.1 Projects having more than 100 dwelling units.
Multiple-family residential projects having more than 100 *dwelling units* shall be equipped throughout with two separate and *approved* fire apparatus access roads.

Exception: Projects having up to 200 *dwelling units* may have a single *approved* fire apparatus access road when all buildings, including nonresidential occupancies, are equipped throughout with *approved automatic sprinkler systems* installed in accordance with Section 903.3.1.1 or 903.3.1.2.

D106.2 Projects having more than 200 dwelling units.
Multiple-family residential projects having more than 200 *dwelling units* shall be provided with two separate and *approved* fire apparatus access roads regardless of whether they are equipped with an *approved automatic sprinkler system*.

SECTION D107 ONE- OR TWO-FAMILY RESIDENTIAL DEVELOPMENTS

D107.1 One- or two-family dwelling residential developments.
Developments of one- or two-family *dwelling units* where the number of *dwelling units* exceeds 30 shall be provided with two separate and *approved* fire apparatus access roads, and shall meet the requirements of Section D104.3.

Exceptions:

1. Where there are more than 30 *dwelling units* on a single public or private fire apparatus access road and all *dwelling units* are equipped throughout with an *approved automatic sprinkler system* in accordance with Section 903.3.1.1, 903.3.1.2 or 903.3.1.3 of the *International Fire Code*, access from two directions shall not be required.
2. The number of *dwelling units* on a single fire apparatus access road shall not be increased unless fire apparatus access roads will connect with future development, as determined by the *fire code official*.

D108 REFERENCED STANDARDS

ASTM F 2200—05 Standard Specification for
Automated Vehicular Gate
Construction

D103.5

4/27/2018

Codes and Standards | ICC publicACCESS

ICC	IFC—12	International Fire Code	D101.5, D107.1
UL	325—02	Door, Drapery, Gate, Louver, and Window Operators and Systems, with Revisions through February 2008	D103.5

Contact Us: 1-888-422-7233 Ext: 33821 | Technical Support: [Support & FAQ for Electronics Productst](#) | [Shop](#)

Copyright © 2016 ICC. All rights reserved.

EXHIBIT K
TO
DEVELOPMENT AND COOPERATION AGREEMENT

Fire and Safety Lane Plans

South Canal shall construct a reinforced grass lane for fire and safety vehicles to access the Proposed Project via Hull Street across Diversity Park in the location determined pursuant to the Agreement, which construction shall be substantially in conformity with the conceptual specifications attached hereto as **Exhibit K-1**.

EXHIBIT
K-1
TO DEL. AGREEMENT

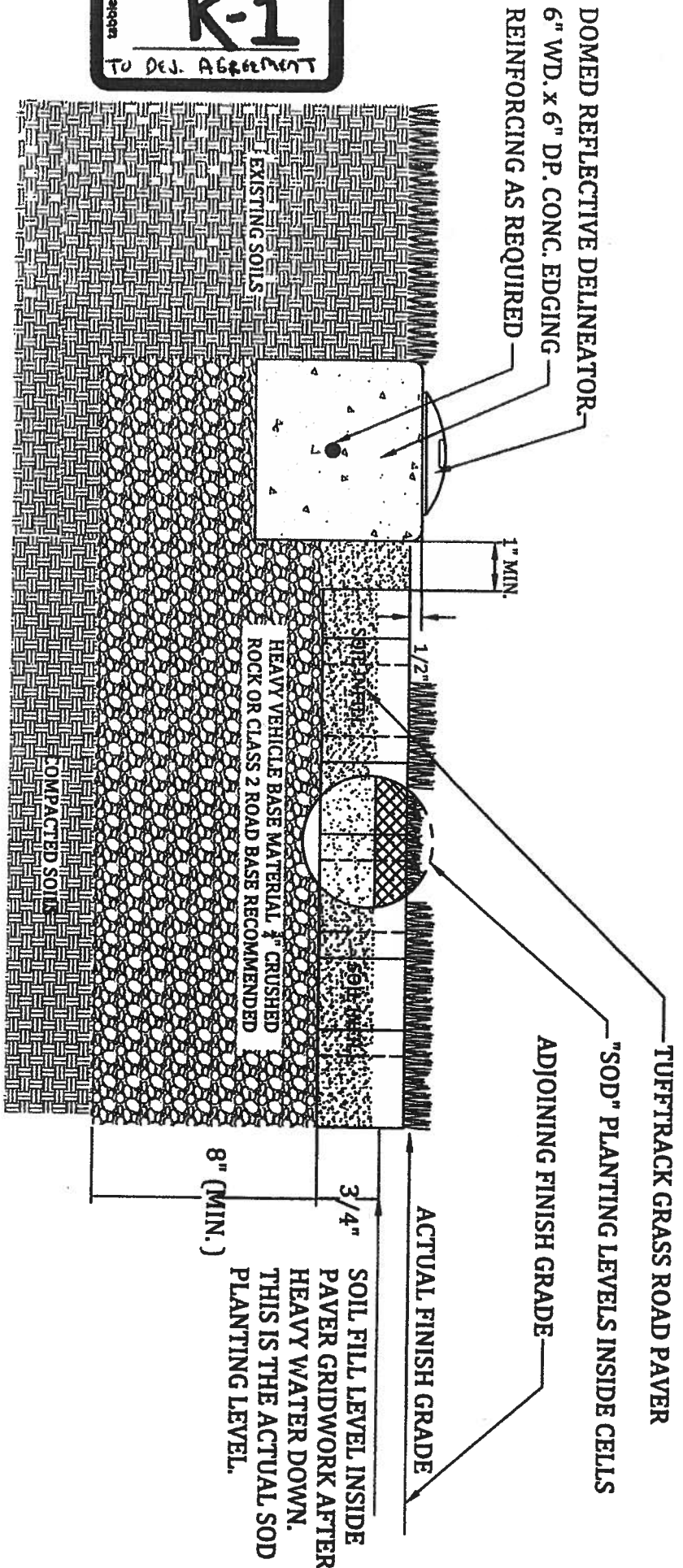

NOTE:

EXISTING SOILS SHOULD BE EVALUATED TO ENSURE PROPER STRUCTURAL AND PERMEABILITY PROPERTIES.

TUFFTRACK GRASS PAVER FIRELANE CONCRETE EDGING W/ REFLECTOR

HEAVY VEHICLE OR FIRE ACCESS ROAD



TECHNICAL SERVICES
1-888-825-4716
techservice@nidspro.com

EXHIBIT
K-1
TO DEV AG 02/26/07

TUFFTRACK PRODUCT DESCRIPTION

PANEL SIZE - 24" x 24" x 1 1/2"
 CELLS PER PANEL - (120) - 2-1/2" HEXAGONAL CELLS
 NESTED HONEYCOMB CELL LAYOUT
 COMPRESSIVE STRENGTH - 98,770 PSF
 685 PSI
 EXCEEDS H2O
 LOADING

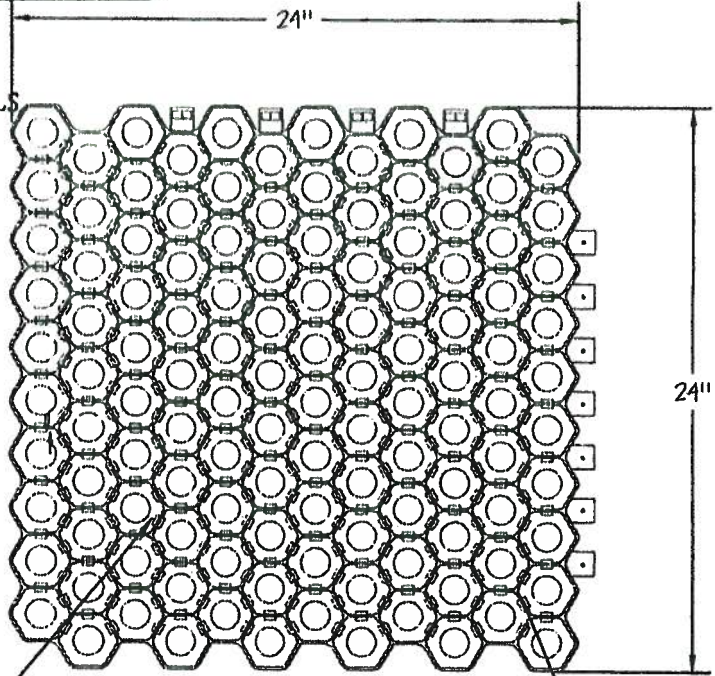

TUFFTRACK GRASS ROAD PAVER

TONGUE & GROOVE LATCHING SYSTEM

"SOD" PLANTING LEVELS INSIDE CELLS

ACTUAL FINISH GRADE

ADJOINING FINISH GRADE

SOIL FILL LEVEL INSIDE PAVER GRIDWORK AFTER HEAVY WATER DOWN. THIS IS THE ACTUAL SOD PLANTING LEVEL.

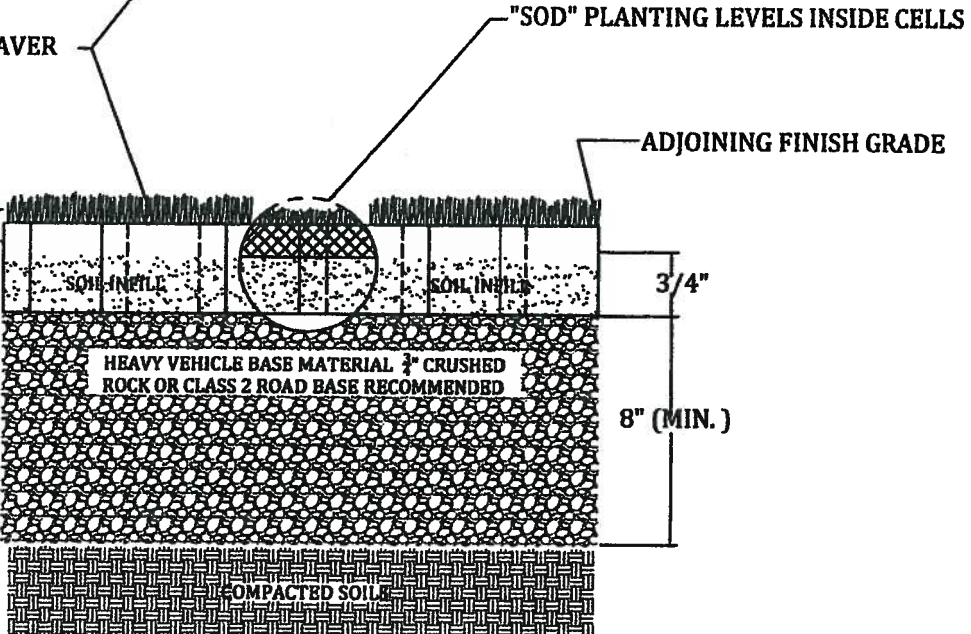

NOTE:

EXISTING SOILS SHOULD BE EVALUATED TO ENSURE PROPER STRUCTURAL AND PERMEABILITY PROPERTIES.



TECHNICAL SERVICES
 1-888-825-4716
 techservice@ndspro.com

TYPICAL TUFFTRACK PAVER FIRELANE DETAIL

HEAVY VEHICLE OR FIRE ACCESS ROAD

N. T. S.