



# COMMISSION OF ARCHITECTURAL REVIEW

## APPLICATION FOR CERTIFICATE OF APPROPRIATENESS

**RECEIVED**

PROPERTY (location of work)

Address 2009 Cedar St.

Historic district UNION HILL

Date/time rec'd: OCT 24 2019  
Rec'd by: ME  
Application #: BY:  
Hearing date: \_\_\_\_\_

### APPLICANT INFORMATION

Name Taner Kaya

Phone 804-277-5372

Company \_\_\_\_\_

Email taner@ecogranite.net

Mailing Address 4297 Carolina Ave. 23222

Applicant Type:  Owner  Agent  
 Lessee  Architect  Contractor  
 Other (please specify): \_\_\_\_\_

### OWNER INFORMATION (if different from above)

Name Eco Marble & Granite, Inc.

Company \_\_\_\_\_

Mailing Address 4297 Carolina Ave. 23222

Phone \_\_\_\_\_

Email taner@ecogranite.net

### PROJECT INFORMATION

Review Type:  Conceptual Review  Final Review

Project Type:  Alteration  Demolition

New Construction  
(Conceptual Review Required)

Project Description: (attach additional sheets if needed)

Single family, new construction.

### ACKNOWLEDGEMENT OF RESPONSIBILITY

**Compliance:** If granted, you agree to comply with all conditions of the COA. Revisions to approved work require staff review and may require a new application and CAR approval. Failure to comply with the COA may result in project delays or legal action. The COA is valid for one (1) year and may be extended for an additional year, upon written request.

**Requirements:** A complete application includes all applicable information requested on checklists to provide a complete and accurate description of existing and proposed conditions. Applicants proposing major new construction, including additions, should meet with Staff to review the application and requirements prior to submitting an application. Owner contact information and signature is required. Late or incomplete applications will not be considered.

**Zoning Requirements:** Prior to Commission review, it is the responsibility of the applicant to determine if zoning approval is required and application materials should be prepared in compliance with zoning.

Signature of Owner [Signature]

Date 10/24/19



**LEFT ELEVATION**  
1/4" = 1'-0"



**FRONT ELEVATION**  
1/4" = 1'-0"



**REAR ELEVATION**  
1/4" = 1'-0"

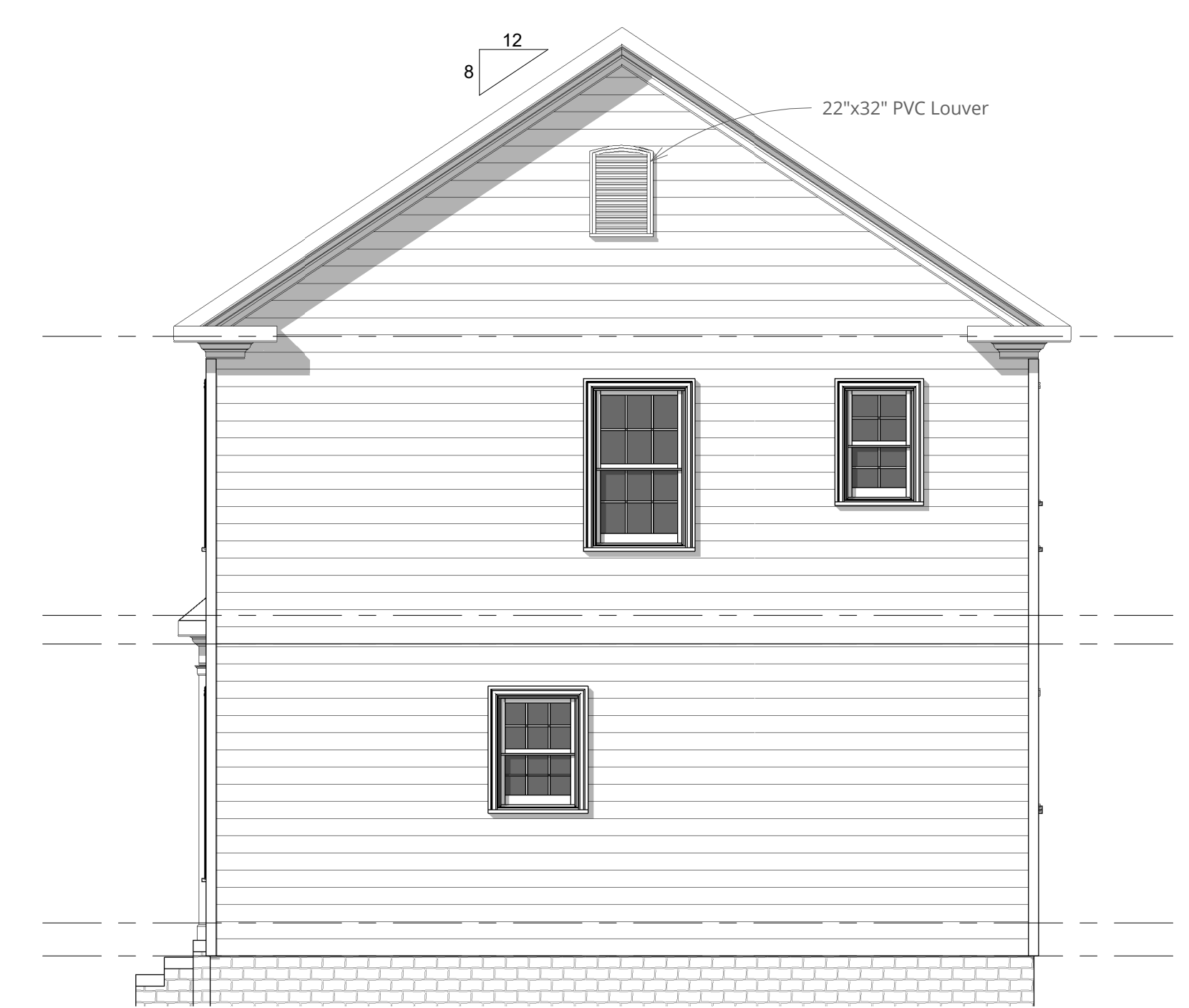

**RIGHT ELEVATION**  
1/4" = 1'-0"

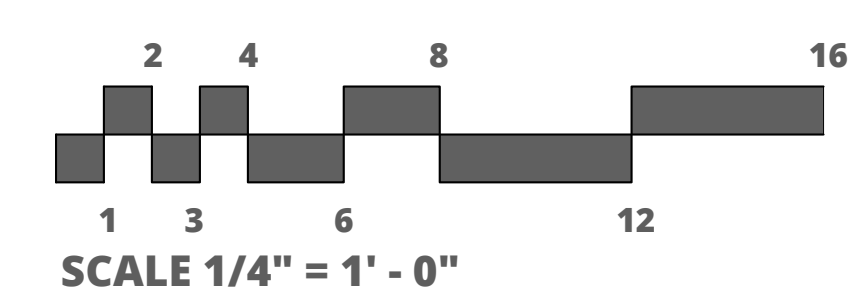

**CarriageStone**  
COTTAGE & HOME DESIGN, LLC  
P. O. Box 1805 -- Glen Allen, Virginia 23060 -- TEL: 804-836-8074  
www.CarriageStone.com

Issue Date: 10-23-19  
Rev. Date:  
Drawn by: Donald L. Files, Jr.

2009 Cedar Street  
TDZ Properties  
2009 Cedar Street  
Richmond, VA 23223

Elevations

**A1**  
Project Number 2019.658  
Scale 1/4" = 1'-0"

10/23/2019 11:23:35 PM

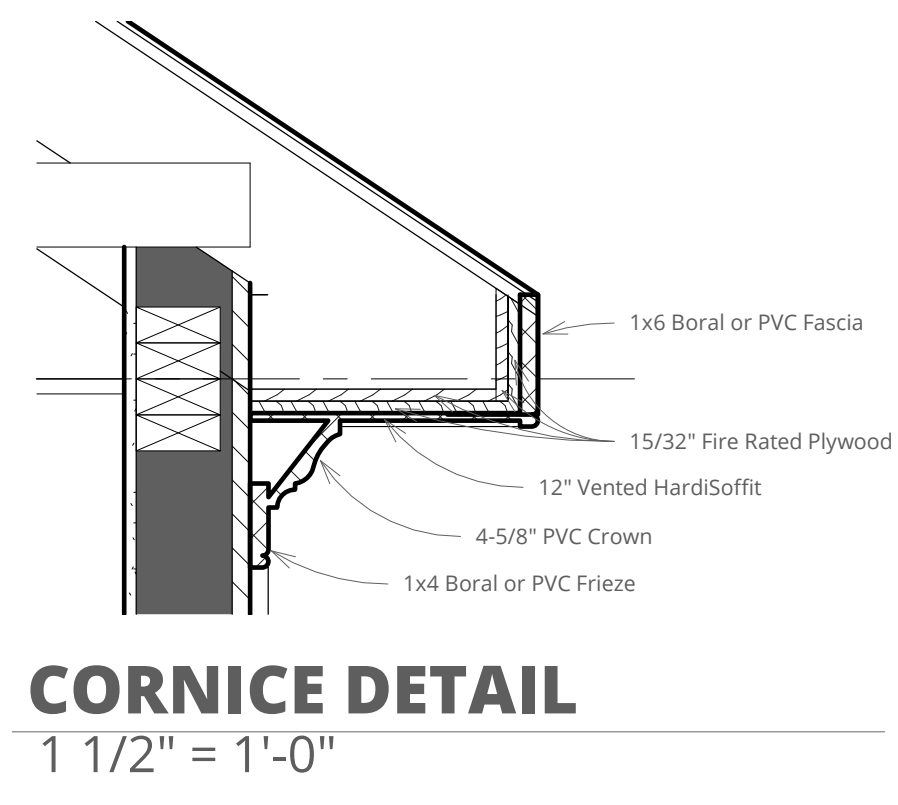
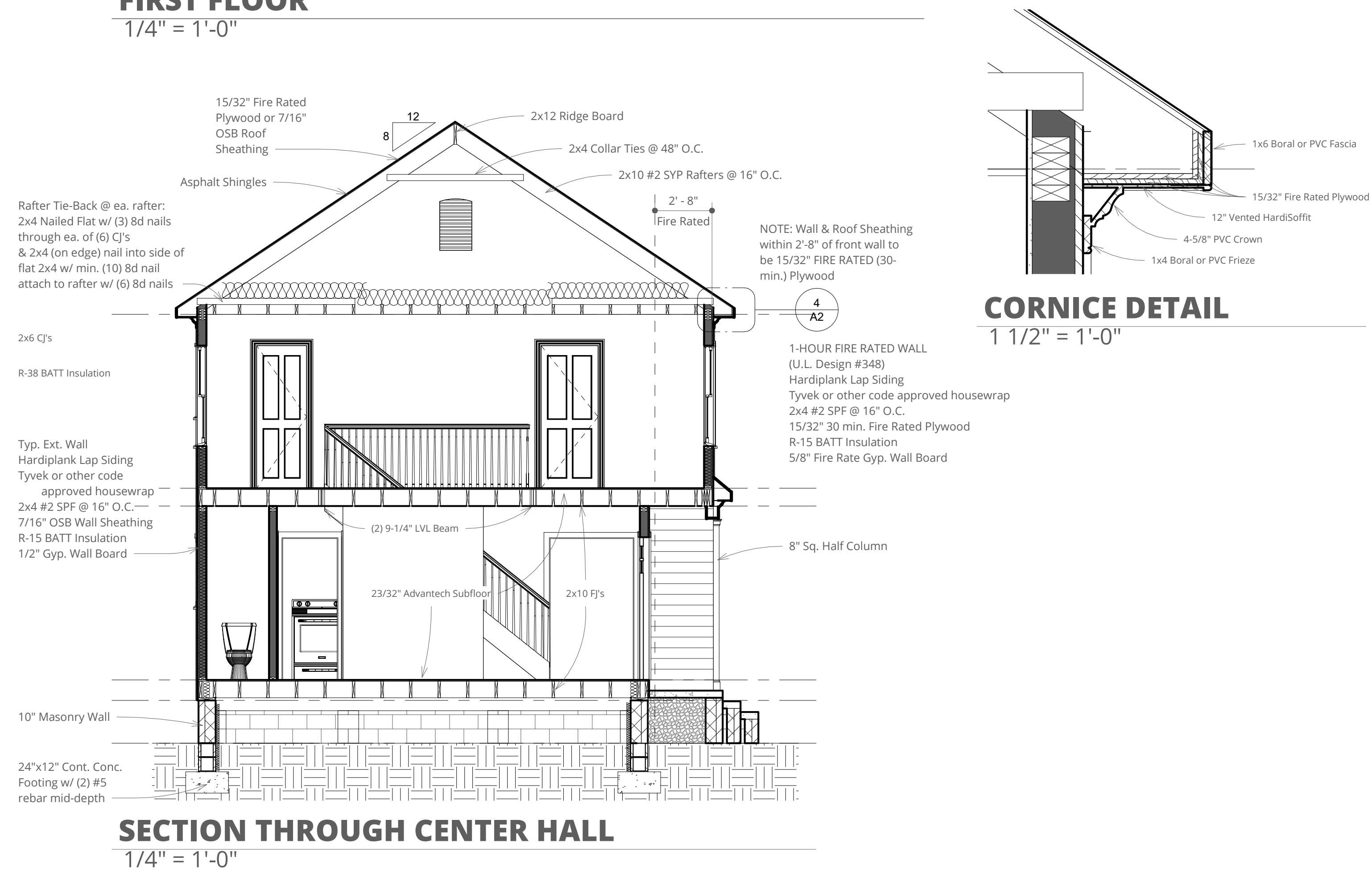
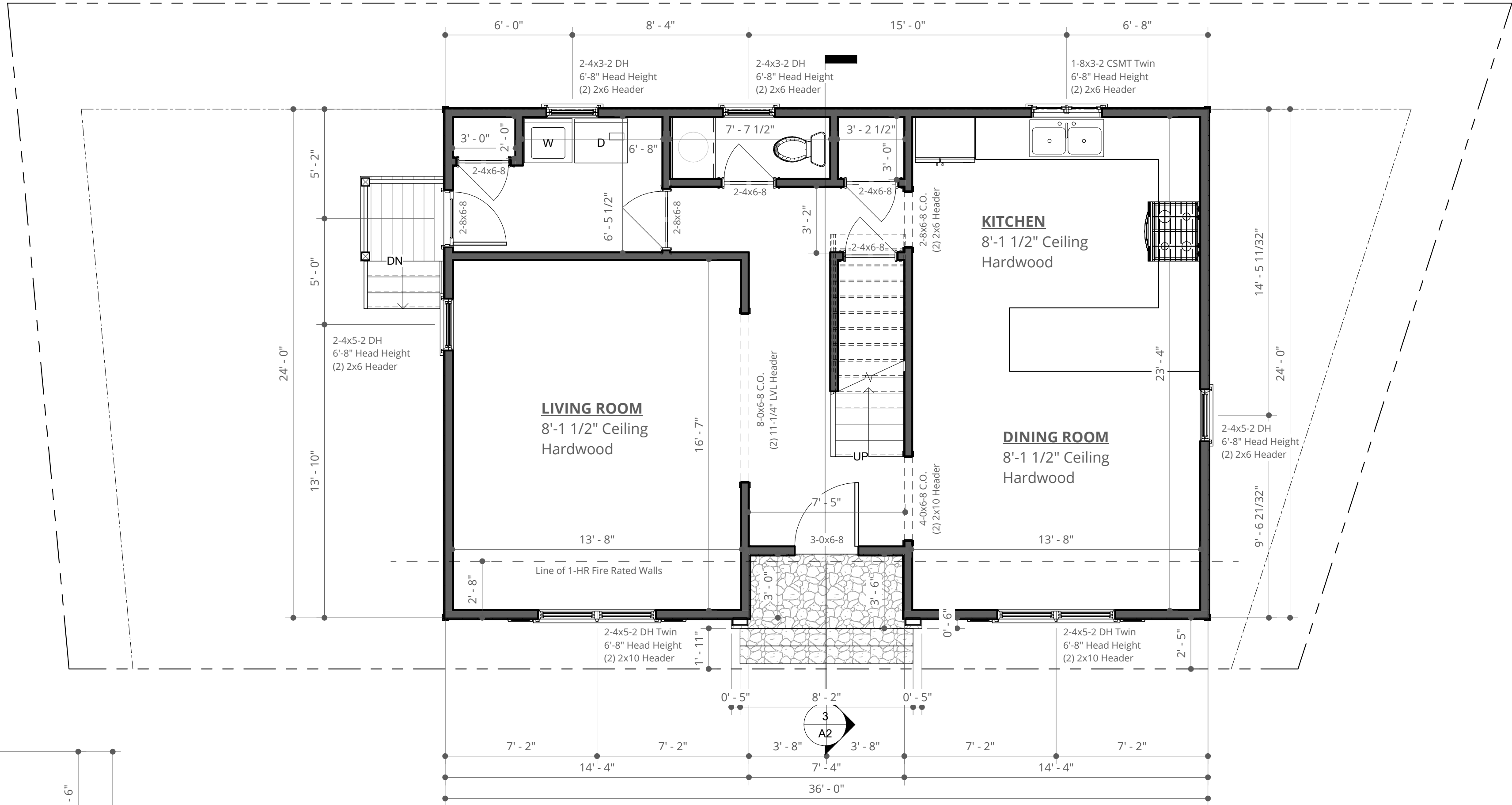
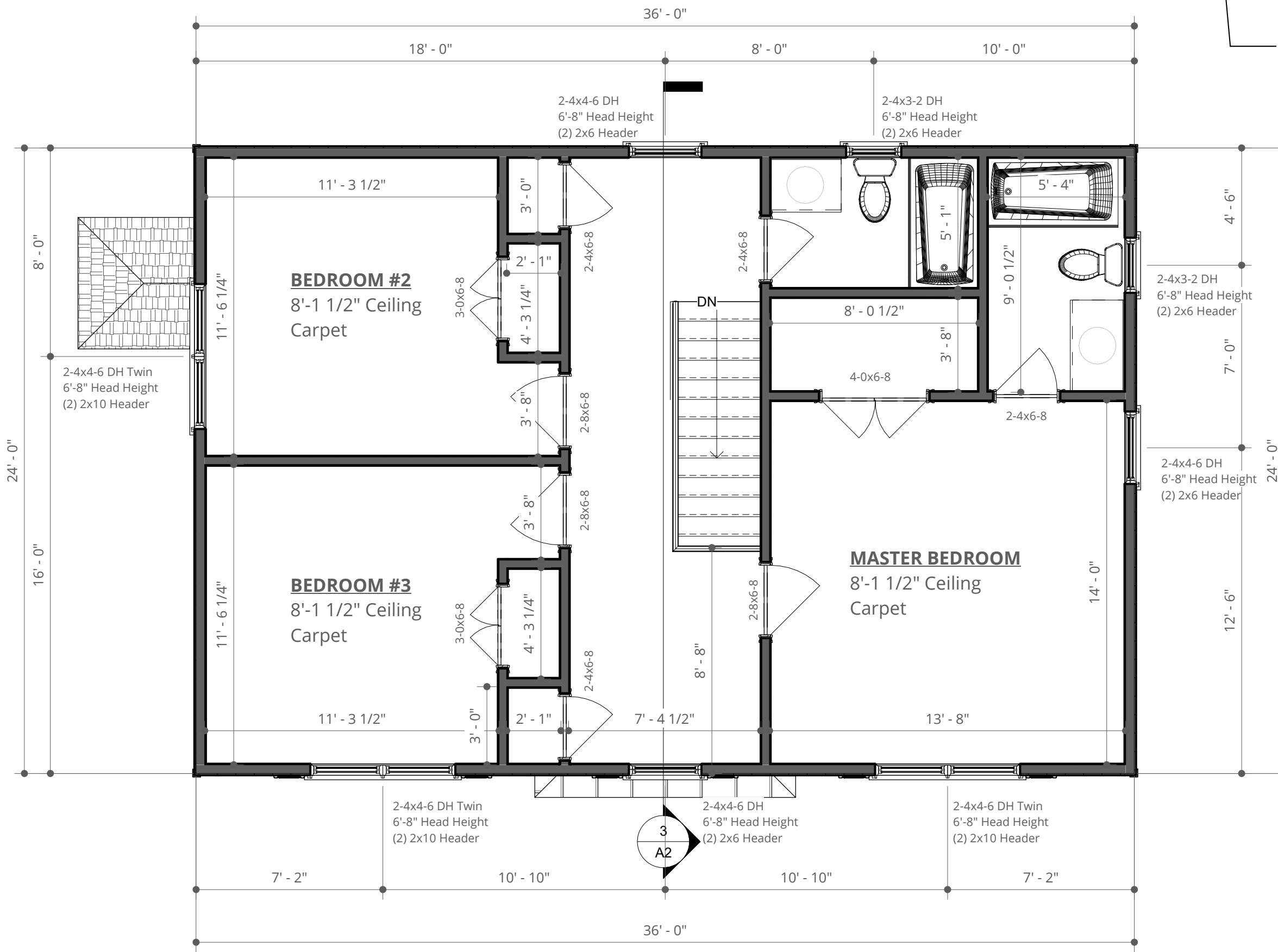

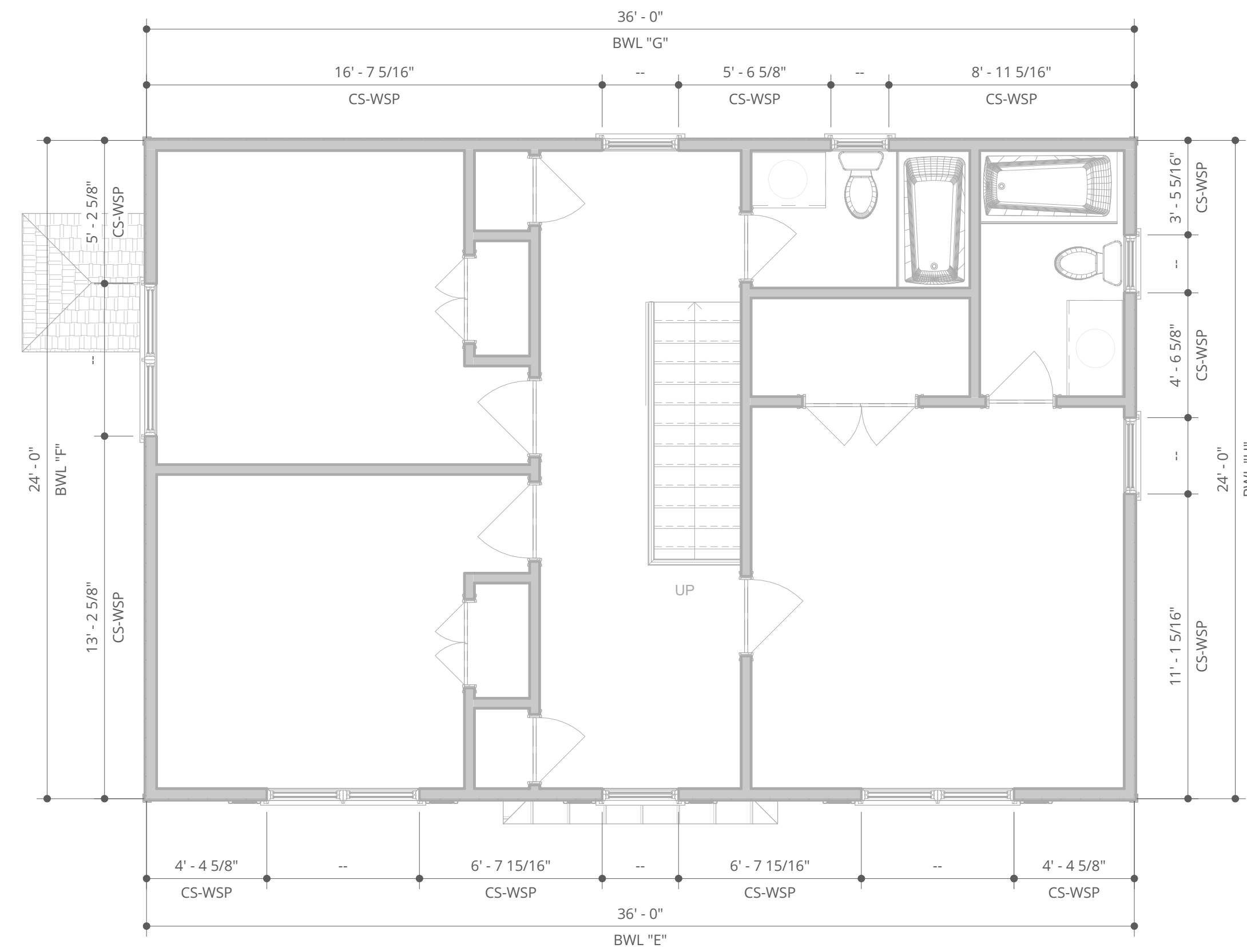

**BRACED WALL PLAN -- SECOND FLOOR**  
1/4" = 1'-0"

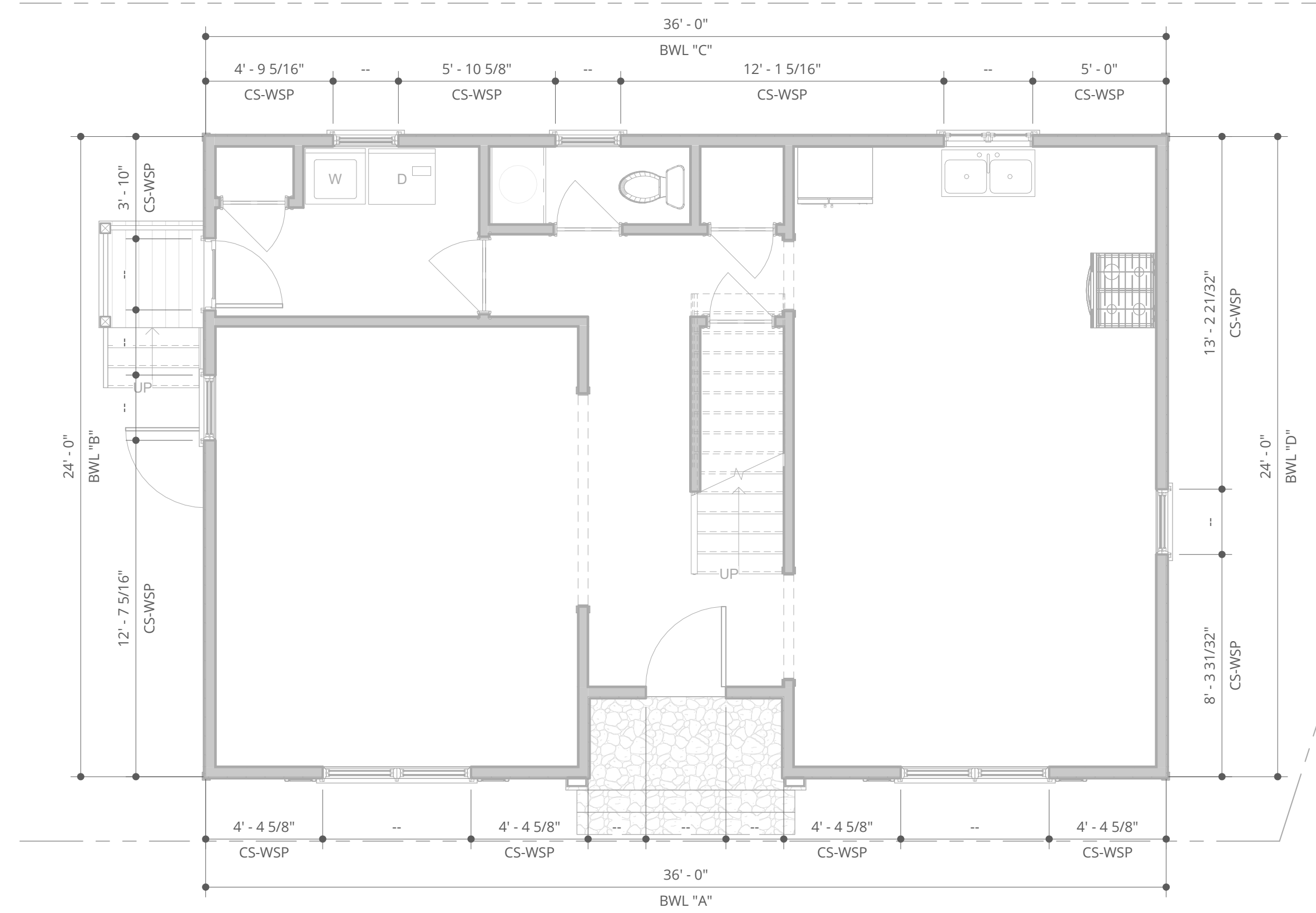

**BRACED WALL PLAN -- FIRST FLOOR**  
1/4" = 1'-0"



**Classic Wall Bracing Worksheet**  
per 2015 Virginia Residential Code Section R602.10

|                                     |            |        |           |        |           |        |           |        |           |        |           |        |           |        |           |        |       |
|-------------------------------------|------------|--------|-----------|--------|-----------|--------|-----------|--------|-----------|--------|-----------|--------|-----------|--------|-----------|--------|-------|
| Ultimate Wind Speed (mph)           | 115        |        |           |        |           |        |           |        |           |        |           |        |           |        |           |        |       |
| BWL Designation                     | A          |        | B         |        | C         |        | D         |        | E         |        | F         |        | G         |        | H         |        |       |
| No. of Floors above BWL             | 1          |        | 1         |        | 1         |        | 1         |        | 0         |        | 0         |        | 0         |        | 0         |        |       |
| BWP Method                          | CS-WSP     |        | CS-WSP    |        | CS-WSP    |        | CS-WSP    |        | CS-WSP    |        | CS-WSP    |        | CS-WSP    |        | CS-WSP    |        |       |
| Average BWL Spacing (ft)            | 24         |        | 36        |        | 24        |        | 36        |        | 24        |        | 36        |        | 24        |        | 36        |        |       |
| Tabular Requirement (ft)            | 7.50       |        | 10.50     |        | 7.50      |        | 10.50     |        | 3.90      |        | 5.40      |        | 3.90      |        | 5.40      |        |       |
| Exposure                            | B 1.00     |        | B 1.00    |        | B 1.00    |        | B 1.00    |        | B 1.00    |        | B 1.00    |        | B 1.00    |        | B 1.00    |        |       |
| Eave-to-Ridge Ht. (ft)              | 9.00 0.97  |        | 9.00 0.97 |        | 9.00 0.97 |        | 9.00 0.97 |        | 9.00 0.94 |        | 9.00 0.94 |        | 9.00 0.94 |        | 9.00 0.94 |        |       |
| Max. Wall Ht. (ft)                  | 8.00 0.90  |        | 8.00 0.90 |        | 8.00 0.90 |        | 8.00 0.90 |        | 8.00 0.90 |        | 8.00 0.90 |        | 8.00 0.90 |        | 8.00 0.90 |        |       |
| No. of BWLs                         | 2 1.00     |        | 2 1.00    |        | 2 1.00    |        | 2 1.00    |        | 2 1.00    |        | 2 1.00    |        | 2 1.00    |        | 2 1.00    |        |       |
| Dim. Interior Finish?               | No 1.00    |        | No 1.00   |        | No 1.00   |        | No 1.00   |        | No 1.00   |        | No 1.00   |        | No 1.00   |        | No 1.00   |        |       |
| Added Hold-downs?                   | No 1.00    |        | No 1.00   |        | No 1.00   |        | No 1.00   |        | No 1.00   |        | No 1.00   |        | No 1.00   |        | No 1.00   |        |       |
| Joints Blocked?                     | No 2.00    |        | Yes 1.00  |        | No 2.00   |        | No 2.00   |        | No 2.00   |        | No 2.00   |        | No 2.00   |        | No 2.00   |        |       |
| Fasteners @ 4' o.c.?                | No 1.00    |        | No 1.00   |        | No 1.00   |        | No 1.00   |        | No 1.00   |        | No 1.00   |        | No 1.00   |        | No 1.00   |        |       |
| Required BWP Length (ft)            | 13.10      |        | 9.17      |        | 13.10     |        | 18.33     |        | 6.60      |        | 9.14      |        | 6.60      |        | 9.14      |        |       |
| Contributing Length (ft)            | BWP Method | Length | Method    | Length | Method    | Length | Method    | Length | Method    | Length | Method    | Length | Method    | Length | Method    | Length |       |
|                                     | 1          | CS-WSP | 4.30      | CS-WSP | 12.50     | CS-WSP | 4.75      | CS-WSP | 13.00     | CS-WSP | 4.30      | CS-WSP | 13.00     | CS-WSP | 16.50     | CS-WSP | 3.30  |
|                                     | 2          | CS-WSP | 4.30      | CS-WSP | 3.88      | CS-WSP | 5.75      | CS-WSP | 8.25      | CS-WSP | 6.50      | CS-WSP | 5.00      | CS-WSP | 8.88      | CS-WSP | 4.50  |
|                                     | 3          | CS-WSP | 4.33      |        |           | CS-WSP | 12.00     |        |           | CS-WSP | 6.50      |        |           | CS-WSP | 8.88      | CS-WSP | 11.00 |
|                                     | 4          | CS-WSP | 4.33      |        |           | CS-WSP | 5.00      |        |           | CS-WSP | 4.33      |        |           |        |           |        |       |
|                                     | 5          |        |           |        |           |        |           |        |           |        |           |        |           |        |           |        |       |
|                                     | 6          |        |           |        |           |        |           |        |           |        |           |        |           |        |           |        |       |
| Actual BWP Length (ft)              | 17.32      |        | 16.38     |        | 27.50     |        | 21.25     |        | 21.66     |        | 18.00     |        | 30.88     |        | 18.83     |        |       |
| Actual ≥ Required?                  | PASS       |        | PASS      |        | PASS      |        | PASS      |        | PASS      |        | PASS      |        | PASS      |        | PASS      |        |       |
| BWPs ≤ 20' Apart?                   | Yes        |        | Yes       |        | Yes       |        | Yes       |        | Yes       |        | Yes       |        | Yes       |        | Yes       |        |       |
| ≥ 2 Panels in BWL?                  | Yes        |        | Yes       |        | Yes       |        | Yes       |        | Yes       |        | Yes       |        | Yes       |        | Yes       |        |       |
| BWP 10' from Ends?                  | Yes        |        | Yes       |        | Yes       |        | Yes       |        | Yes       |        | Yes       |        | Yes       |        | Yes       |        |       |
| Continuous Sheathing End Conditions | End 1      | End 2  | End 1     | End 2  | End 1     | End 2  | End 1     | End 2  | End 1     | End 2  | End 1     | End 2  | End 1     | End 2  | End 1     | End 2  |       |
| BWL Compliance                      | PASS       |        | PASS      |        | PASS      |        | PASS      |        | PASS      |        | PASS      |        | PASS      |        | PASS      |        |       |

To report an error or bug, call 703-324-1842, TTY 711. A Fairfax County, Virginia Publication. Classic VRC2015.1 - 3/26/2019

Issue Date: 10-23-19  
Rev. Date:

Drawn by: Donald L. Files, Jr.

2009 Cedar Street  
TDZ Properties  
2009 Cedar Street  
Richmond, VA 23223

Braced Wall Plans

A3

Project Number 2019.658  
Scale 1/4" = 1'-0"

10/23/2019 11:23:54 PM

## GENERAL NOTES

- All work for this project shall conform with all governing laws, codes, & ordinances including, but not limited to, the 2015 International Residential Code and the 2015 Virginia Residential Code.
- The builder/contractor shall be solely responsible for all means and methods of construction. This shall specifically include on-site procedures as they relate to the safety of the construction crew and the general public.
- The builder/contractor shall take special care to protect any existing structures to avoid any damage relating to work during this project.
- The builder/contractor shall provide clean-up of debris and trash at regular intervals in order to keep the site and work areas reasonably clean of unsafe and unsightly accumulation.
- The builder/contractor shall also provide a professional cleaning at project completion.
- Actual finish floor area will vary. Actual finish dimensions are not shown and will vary.
- All rights in and to these drawings are owned by CarriageStone Cottage & Home Design, LLC, a Virginia LLC. They shall not be reproduced, modified, or revised in any way without the written consent from, and proper compensation to, CarriageStone Cottage & Home Design, LLC. Any use of these drawings is strictly prohibited unless pursuant to an authorized and paid for CarriageStone Cottage & Home Design, LLC LICENSE AGREEMENT. The use hereof is subject to agreement to the terms, qualifications, and conditions thereon. CarriageStone Cottage & Home Design, LLC shall protect this right and be reimbursed for all legal and court costs, etc., for any necessary protection of the drawings.
- Parties utilizing any aspect of these drawings are responsible for consulting with qualified builders/contractors, engineers, and other professionals regarding the feasibility, legality, and safety of using these drawings. The use of these drawings are at one's own risk and their user waives any claims thereon.
- Submission of these drawings to any public body for any use does not release in any way the copyright and ownership of drawings provisions listed herein.

## FOOTING & MASONRY NOTES

- Soil conditions are assumed to be 2,000psf.
- Exterior dimensions are to face of masonry or wall sheathing.
- Continuous concrete footings shall be constructed of minimum 2,500psi concrete. See plan details for width and thickness.
- Provide minimum 2-courses x 24" wide grouted solid under all steel beams or concentrated loading conditions. Consult Soil Report for additional size and rebar specifications.
- Exterior steps are shown for location only. Contractor shall determine and verify all grade elevations and number of steps required.
- Anchor bolts shall be placed at a maximum of 6 feet on center. There shall be a minimum of two bolts per plate section with one bolt located no more than 12 inches, or less than seven bolt diameters, from each end of the plate section. Bolts shall be a minimum 3/4" in diameter and shall extend a minimum of 7 inches into masonry or concrete.
 

Exceptions:

  - Walls 24 inches total length or shorter connecting offset braced wall panels shall be anchored to the foundation with a minimum of one anchor bolt located in the center third of the plate section and shall be attached to adjacent braced wall panels.
  - Walls 12 inches total length or shorter connecting offset braced wall panels shall be permitted to be connected to the foundation without anchor bolts.
- Brick veneer walls to have non-corrosive metal ties @ 16" O.C. vertically and horizontally and weep holes at 24" O.C. at base flashing.
- Provide minimum 4" bearing at each end of lintels for brick veneer walls

## NON-VENTED CRAWLSPACE NOTES

- Permanently install insulation to crawlspace walls from top of foundation downward to finished grade level and then vertically and/or horizontally for at least an additional 24 inches.
- All insulation material to be noncombustible or at a minimum have a noncombustible facing material.
- Install continuous vapor retarder where earth is exposed in the crawlspace. Overlap joints by minimum of 6 inches with edges sealed or taped. Extend the vapor retarder minimum of 6 inches up the stem wall and attach and seal to wall.
- Make sure crawlspace is clean and clear of all trash and debris, including all loose wood and organic material, prior to installing vapor barrier.
- Provide conditioned air supply sufficient to deliver at a rate of 1 cfm for each 50 square feet of crawlspace area. Install a return air pathway to the finished space above via a duct or transfer grille.

## ROOFING NOTES

- Roofing contractor to install Ice & Water Shield on roof from eave to 2' inside exterior wall line.
- Install minimum 15# roofing felt underlayment between roof sheathing and finish roofing material. Where roof slope is 4/12 or less, apply two layers of 15# roofing felt or, preferably, two layers Ice & Water Shield.
- Open valleys shall be flashed with minimum 16 oz. copper or 26 gauge galvanized corrosion resistant sheet metal and shall extend minimum 8" from center line each way.
- Ridge flashing shall be installed per manufacturer's specifications.
- Provide copper or non-corrosive aluminum drip edge flashing at roof edge.
- Crickets shall be installed on the ridge side of any chimney or penetration more than 30 inches wide as measured perpendicular to the slope. Cricket coverings shall be metal or the same material as the roof covering.
- Flashing against a vertical sidewall shall consist of minimum 16 oz. copper or 26 gauge galvanized corrosion resistant sheet metal step flashing as required to maintain minimum height.

## CONCRETE SLAB NOTES

- Concrete slabs on ground floors, including basement slabs and garage slabs, shall be a minimum of 3-1/2 inches thick.
- Minimum compressive strength for basement slabs and interior floor slabs on grade shall be 2,500 psi.
- Minimum compressive strength for garage slabs shall be 3,000 psi.
- All slabs for porches, carports, garages, and steps exposed to weather shall have a minimum compressive strength of 3,500 psi.
- The area within the foundation walls shall have all vegetation, top soil, and foreign material removed.
- Fill material shall be free of organic material as well as other foreign debris.
- Install a minimum of 4 inches of clean #57 stone as a base course.
- Concrete shall be reinforced by one of two methods:
  - 6" Wire mesh supported in the center to upper third of the slab.
  - Adding fiberglass reinforcing fibers to the concrete prior to pouring and finishing.
- For basement slabs, install a vapor retarder of minimum 6 mil polyethylene with joints lapped not less than 6 inches between the base course and the concrete slab.
- All basement and garage slabs shall be insulated with a minimum of R-10 foam insulation projecting a minimum of 24 inches by a combination of vertical insulation and insulation extending under the slab.
- The top edge of the insulation, installed between the exterior wall and the edge of the interior slab, shall be cut at a 45 degree angle away from the exterior wall.
- All basement and garage slabs shall be troweled to a smooth finish.
- Garage slabs shall be sloped toward the garage doors at a minimum rate of 1/8" per foot.
- All sub-slabs for brick or stone porch paving shall be finished level.
- Porch slabs greater than 18 inches above grade shall be supported by galvanized steel composite decking and beams/pipes sized as necessary. Porch slabs less than 18 inches above grade shall be supported by #57 clean stone.
- Clean all foundation areas of loose debris, trash, and organic material prior to installation of composite decking.

## FRAMING NOTES

- Exterior dimensions are to face of masonry or wall sheathing.
- Interior dimensions are to face of studs.
- On an Addition or Renovation project, shaded walls indicate existing walls that shall remain.
- Solid bearing within walls indicated by shaded marks.
- Sleeping Room spans are based on 30# per square foot Live Load and 10# per square foot Dead Load. All Other Room spans are based on 40# per square foot Live Load and 10# per square foot Dead Load. Roof rafters are based on 20# per square foot Live Load and 10# per square foot Dead Load.
- Unless otherwise noted, #2SYP is assumed for all framing lumber when calculating maximum spans.
- Unless otherwise noted, all stud framing is assumed to be #2 SPF.
- Provide pressure treated sill plates, anchored to the foundation with anchor bolts spaced at maximum of 6 feet on center. There shall be a minimum of two bolts per plate section with one bolt located no more than 12 inches, or less than seven bolt diameters, from each end of the plate section. A nut and washer shall be tightened on each bolt of the plate.
- Provide pressure treated lumber for all beams and members within 12" of finished grade.
- Provide pressure treated band board and sill wherever any decks meets the house.
- All metal fasteners and connectors into pressure treated lumber must be listed "ACQ Approved" Hot Dipped Galvanized or Stainless Steel.
- Double joists under all parallel partitions or cabinetry.
- Unless otherwise noted, all sawn lumber headers/beams to receive (2) jack studs and (1) king stud @ each end.
- Unless otherwise noted, all LVL's to be minimum 1.9E.
- Unless otherwise noted, all double LVL's get (3) jacks each end and all triples get (4) jacks each end.
- Unless otherwise noted, all door & window headers to be (2) 2x10's.
- All wall sheathing to be 3/2" CDX Plywood or 7/16" OSB with Tyvek Housewrap or 15" Felt.
- All sub flooring to be glued and nailed.
- All roof sheathing to be 3/2" CDX Plywood or 7/16" OSB.

## BRACED WALL REQUIREMENT NOTES

- BRACED WALL REQUIREMENTS: Lateral stability for this structure is provided by continuous wood panel sheathing per IRC-2015 code R602.10.4.2 (Continuous Sheathing Methods).
- Connection criteria for continuous wood panel sheathing shall be 6d common nails at 6" spacing at panel edges and 12" spacing at intermediate supports (studs). 16 gauge x 1-3/4" staples may also be used at 3" spacing at panel edges and 6" spacing at intermediate supports (studs).
- All wall sheathing to be 3/2" CDX Plywood or 7/16" OSB with Tyvek Housewrap or 15" Felt.

## WINDOW & DOOR NOTES

- A minimum U-Factor of .35 shall be used for all glazing.
- Each sleeping room shall have at least one operable window or exterior door approved for Emergency Egress or Rescue. All Egress or Rescue windows from sleeping room must have a minimum net clear opening of 5.7 square feet. Verify this requirement with the window supplier prior to placement of the order.
- Follow manufacturer's recommended installation instructions.
- Install each window & door with wood (cedar) shims at minimum of three points along each side.

## INSULATION NOTES

### Requirements for Climate Zone 4

|                       |     |
|-----------------------|-----|
| Fenestration U-Factor | .35 |
| Skylight U-Factor     | .55 |
| Ceiling R-Value       | 38  |

- Exceptions:
- N1102.2.1 Ceilings with attic spaces.**  
When Section N1102.1.1 would require R-38 in the ceiling, installing R-30 over 100 percent of the ceiling area shall be deemed to satisfy the requirement for R-38 wherever the full height of uncompressed R-30 insulation extends over the wall top plate at the eaves. Similarly, when Section N1102.1.1 would require R-49 in the ceiling, installing R-38 over 100 percent of the ceiling area shall be deemed to satisfy the requirement for R-49 wherever the full height of uncompressed R-38 insulation extends over the wall top plate at the eaves. This reduction shall not apply to the U-factor alternative approach in Section N1102.1.3 and the total UA alternative in Section N1102.1.4.

- N1102.2.2 Ceilings without attic spaces.**  
Where Section N1102.1.1 would require insulation levels above R-30 and the design of the roof/ceiling assembly does not allow sufficient space for the required insulation, the minimum required insulation for such roof/ceiling assemblies shall be R-30. This reduction of insulation from the requirements of Section N1102.1.1 shall be limited to 500 square feet (46 m<sup>2</sup>) or 20 percent of the total insulated ceiling area, whichever is less. This reduction shall not apply to the U-factor alternative approach in Section N1102.1.3 and the total UA alternative in Section N1102.1.4.

|                         |   |
|-------------------------|---|
| Wood Frame Wall R-Value | 15  |
| Mass Wall R-Value       | 8/13  |
| Floor R-Value           | 19  |
| Basement Wall R-Value   | 10/13 (The first R-Value applies to continuous insulation, the second to framing cavity insulation; either insulation meets the requirement.) |

|                          |   |
|--------------------------|---|
| Slab R-Value and Depth   | 10, 2 ft.   |
| Crawl Space Wall R-Value | 10/13 (The first R-Value applies to continuous insulation, the second to framing cavity insulation; either insulation meets the requirement.) |

## INTERIOR FINISHING NOTES

- All edges and ends of gypsum wall board shall occur on framing members except those edges perpendicular to framing members.
- All gypsum wall board shall be glued and nailed/screwed. Edges to be taped and finished with three coats of mud. Nail/Screw holes to also receive three coats. Allow sufficient drying time between coats so as to minimize "nail pops". Sand between coats to create a smooth finish.
- All gypsum wall board to receive one prime coat and two finish coats of acrylic latex paint. Allow sufficient drying time between coats.
- Prep any areas where wall paper is to be installed with suitable sizing agent.
- Interior trim that is to be painted shall be milled of FJ Pine, Clear White or Yellow Pine, or Clear Poplar. Trim that is to be stained shall be milled of Clear White Pine, Clear Poplar, or other hardwood as selected by homeowner.
- Mitered joints shall be glued to ensure a tight fitting joint.
- Field-laid hardwood flooring shall be installed with a layer of red rosin paper separating the hardwood and the subfloor. Hardwood shall be sanded, stained, and finished with a minimum of two (preferably three) top coats of polyurethane. Stain color and finish sheen to be selected by homeowner.
- Ceramic tile flooring and shower walls shall be installed on Durock (from U.S. Gypsum) or hardibacker (from James Hardie) backer boards. All ceramic tile shall be set in thinset cement.
- Ceramic tile for countertop backsplashes may be installed with mastic directly on gypsum wall board.
- Grout all ceramic tile floors and walls. For gaps up to 1/8 inch, use non-sanded grout. For gaps greater than 1/8 inch, use sanded grout. Color to be selected by homeowner.
- Seal all grout joints once sufficiently dry.

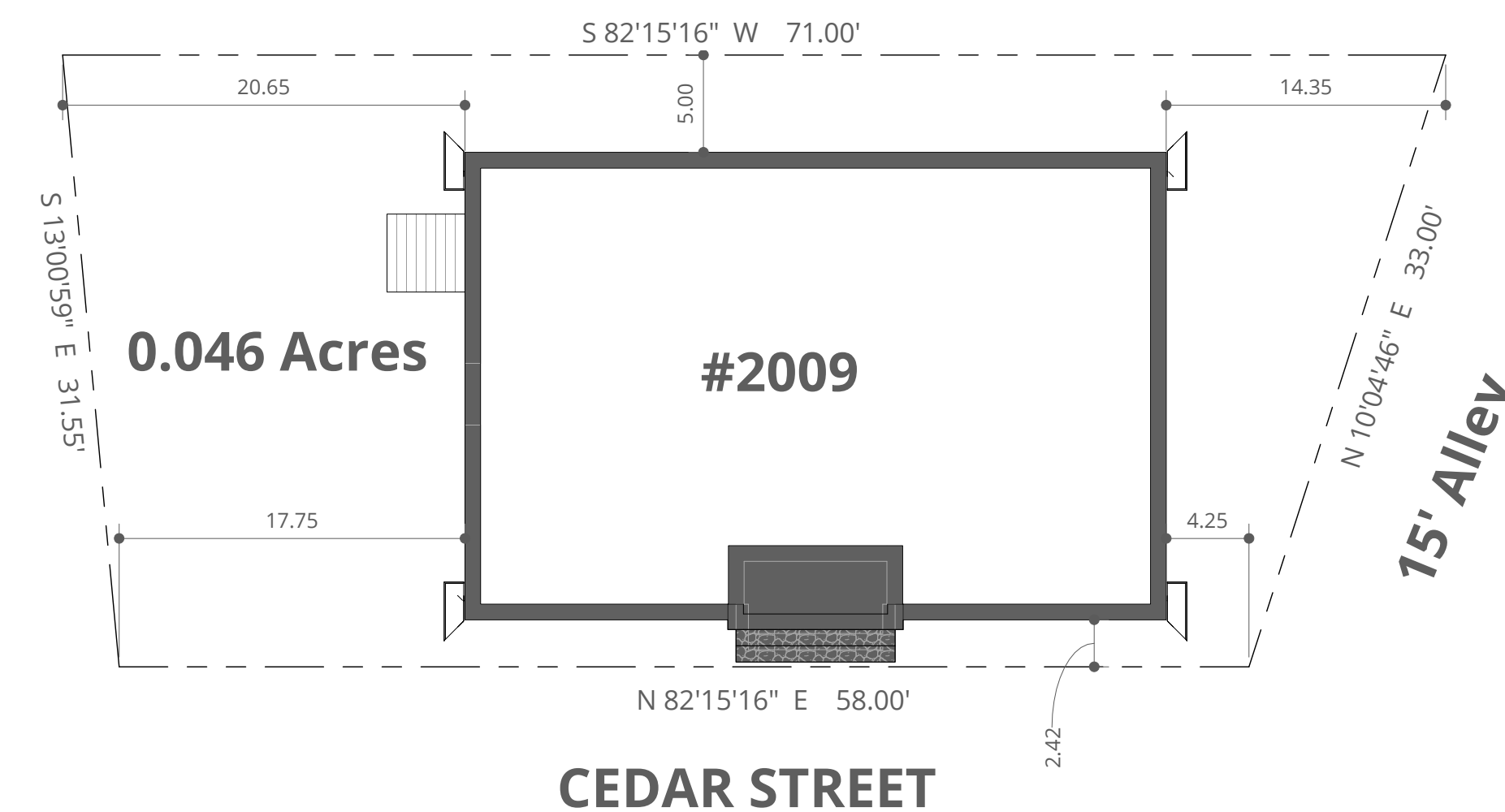

**Site Plan**  
1/8" = 1'-0"

**CarriageStone**  
COTTAGE & HOME DESIGN, LLC

P. O. Box 1805 -- Glen Allen, Virginia 23060 -- TEL: 804-836-8074  
www.CarriageStone.com

Issue Date: 10-23-19  
Rev. Date:

Drawn by: Donald L. Files, Jr.

2009 Cedar Street

TDZ Properties  
2009 Cedar Street  
Richmond, VA 23223

Cover Sheet & Notes

**CS1**

Project Number 2019.658  
Scale As indicated



**1st FLOOR CJ FRAMING PLAN**  
1/4" = 1'-0"

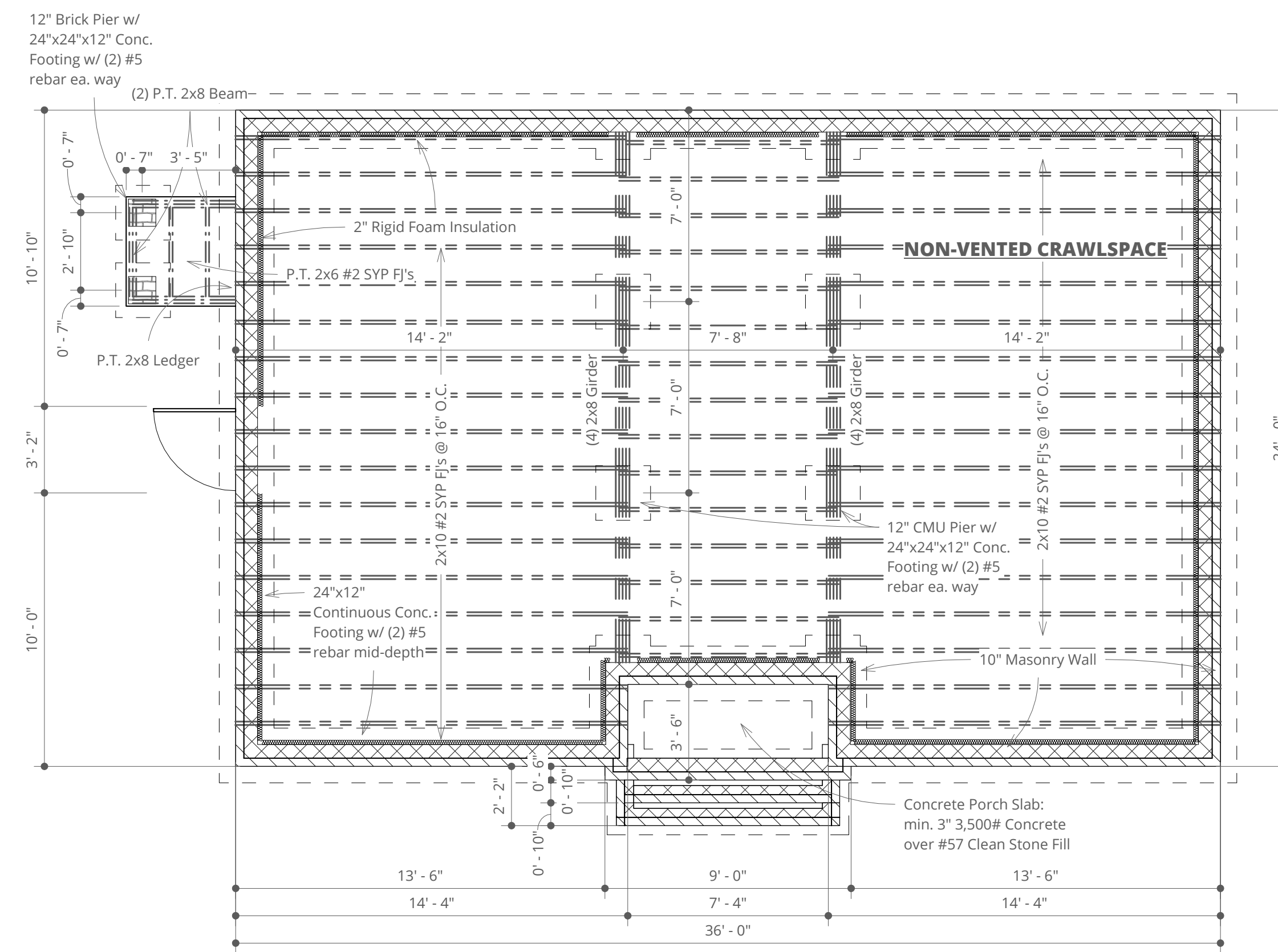

**FOOTINGS & FOUNDATION PLAN**  
1/4" = 1'-0"

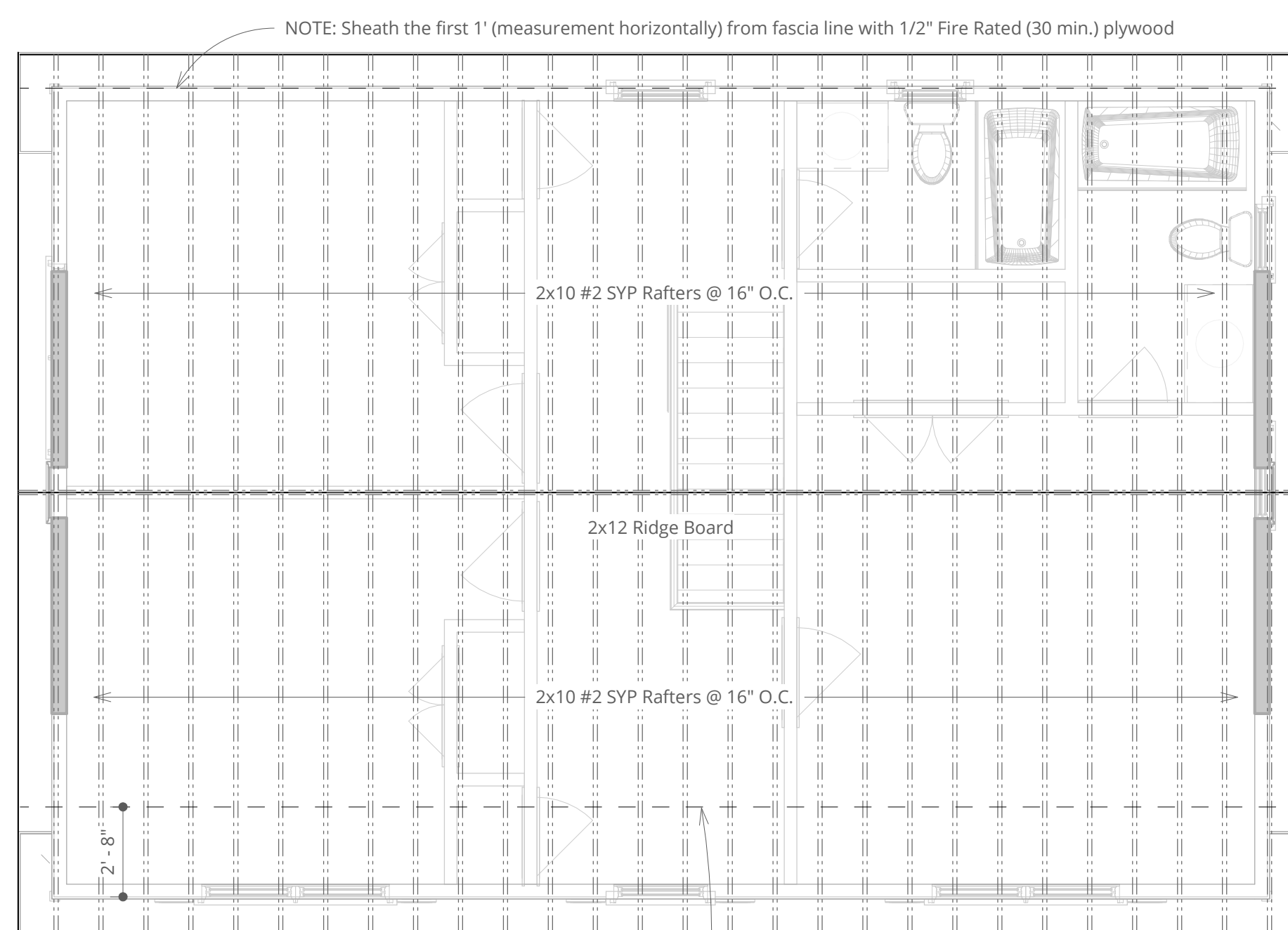

**ROOF FRAMING PLAN**  
1/4" = 1'-0"

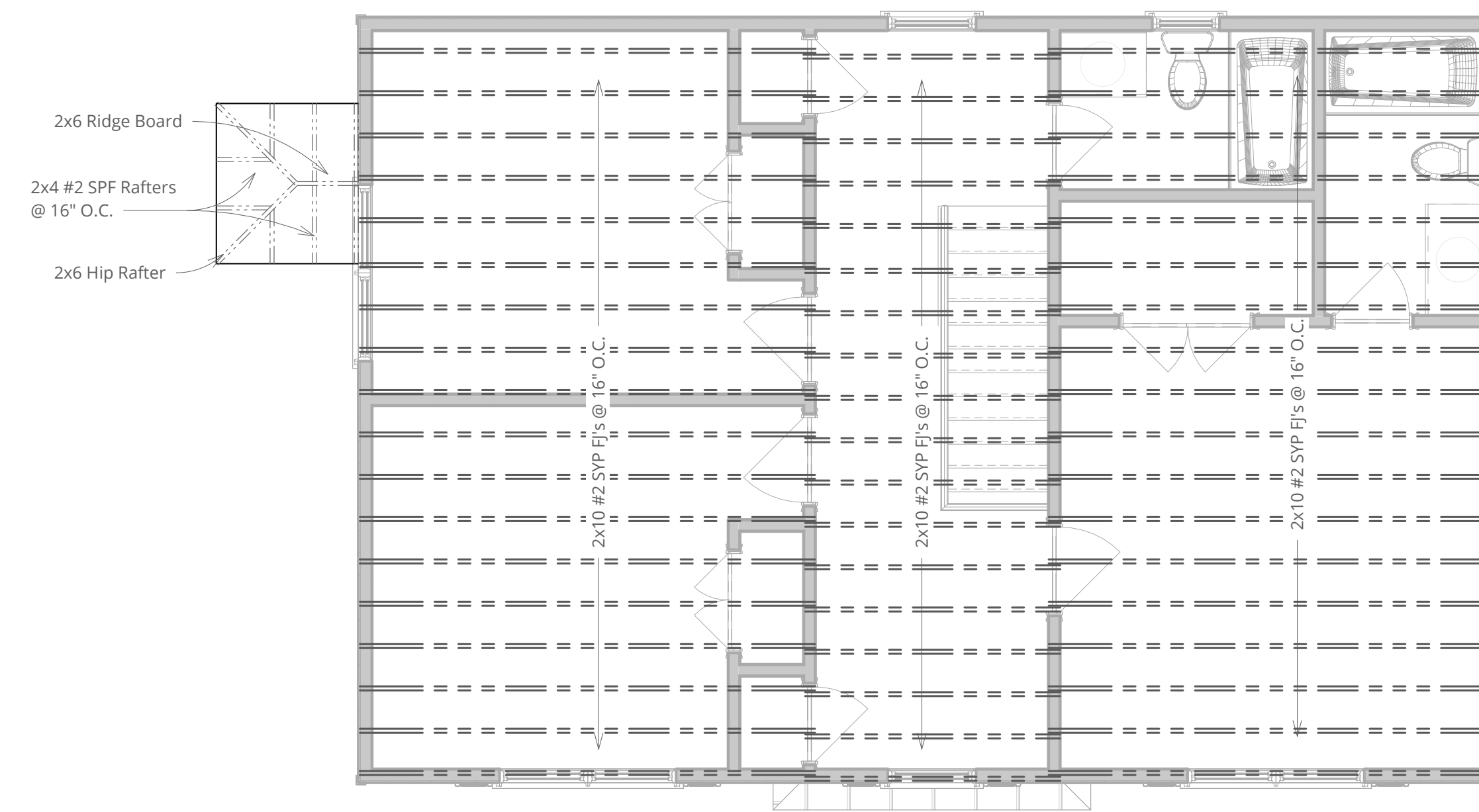

**2nd FLOOR CJ FRAMING PLAN**  
1/4" = 1'-0"