



COMMISSION OF ARCHITECTURAL REVIEW
APPLICATION / CERTIFICATE OF APPROPRIATENESS

PROPERTY (Location of Work)

Address 2701 W. GRACE STREET
Historic District FAN AREA (?)

PROPOSED ACTION

- Alteration (including paint colors)
Addition
Rehabilitation
Demolition
New Construction (Conceptual Review required)
Conceptual Review
Final Review

REMOVE & REPLACE EXISTING FRONT PORCH

OWNER

Name ECHOL MARSHALL
Company GRACE ST 2701 LLC
Mailing Address 4719 SYLVAN RD. RICHMOND, VA 23225
Phone 804-398-8209
Email echol.marshall@gmail.com
Signature [Signature]
Date 6-9-17

APPLICANT (if other than owner)

Name
Company
Mailing Address
Phone
Email
Signature
Date

ACKNOWLEDGEMENT OF RESPONSIBILITY

Requirements: A complete application includes all applicable information requested on checklists to provide a complete and accurate description of existing and proposed conditions. Preliminary review meeting or site visit with staff may be necessary to process the application. Owner contact information and signature is required. Late or incomplete applications will not be considered.

Zoning Requirements: Prior to CAR review, it is the responsibility of the applicant to determine if zoning approval is required and application materials should be prepared in compliance with zoning.

Compliance: If granted, you agree to comply with all conditions of the COA. Revisions to approved work require staff review and may require a new application and CAR approval. Failure to comply with the COA may result in project delays or legal action. The COA is valid for one (1) year and may be extended for an additional year, upon written request.

(Space below for staff use only)

Application received:

Date/Time

Complete [] Yes [] No

By

Current Owner: Naji & Raine Salhab
 Property Address: 2701 W. Grace Street
 Parcel ID: W0001210021
 Purchasers: Grace Street 2701, LLC

Protracted From
 City Of Richmond
 Baseline Map 36-S.E.

N. MULBERRY STREET

N 53°00'00" W
 30.00'

15' Alley

F/Rod

F/Rod

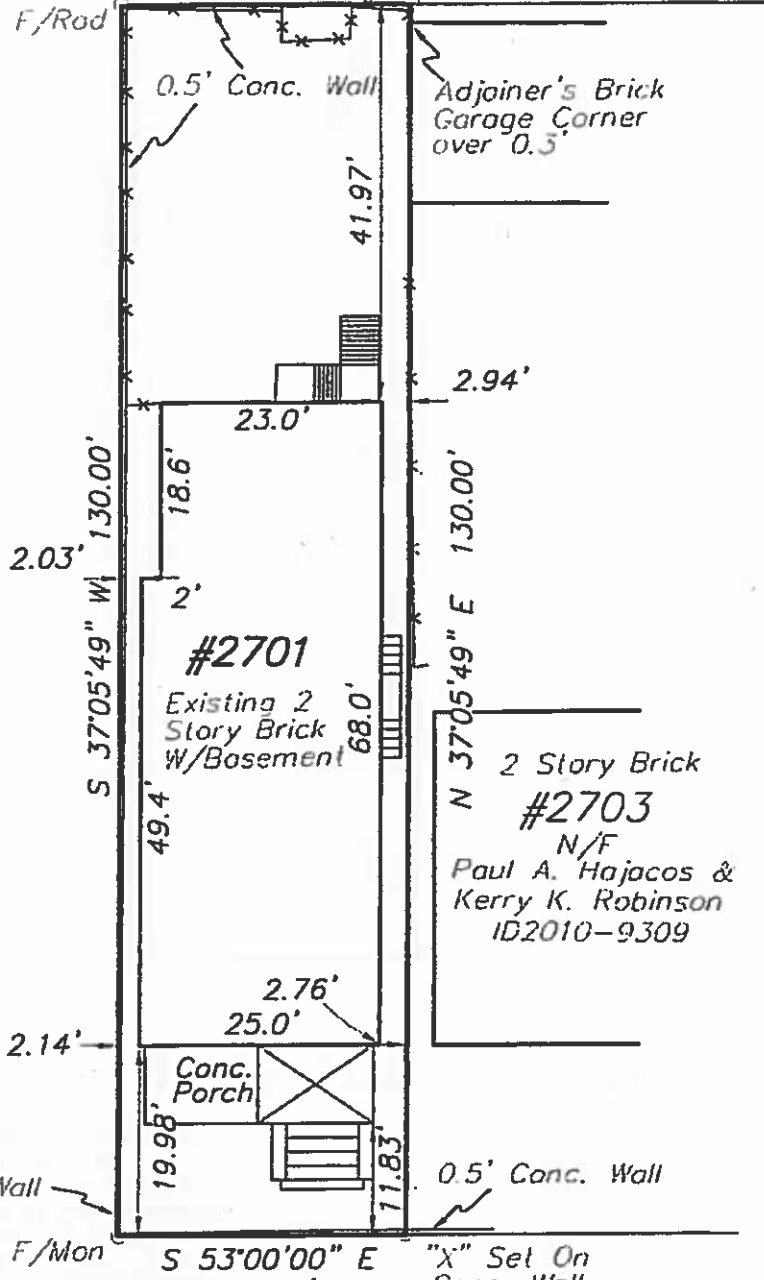

Note: All Fences are 6' Wood Privacy Unless shown otherwise

W. GRACE STREET

This is to certify that on 05/26/16 I made an accurate field survey of the premises shown hereon that all improvements and easements known or visible are shown hereon, that there are no encroachments by improvements either from adjoining premises or from subject premises upon adjoining premises other than shown hereon. THIS PLAT WAS MADE WITHOUT THE BENEFIT OF A TITLE SURVEY OR REPORT.

Plat Showing
 Location of Improvements on
#2701 W. Grace Street
Situated along the Western
Line Of N. Mulberry Street
 City Of Richmond, Virginia

FLOOD INSURANCE NOTE: By graphics plotting only, this property is in ZONE X of the Flood Insurance Rate Map, Community Panel No. 510129-0036D effective date of 04/02/09. Exact designations can only be determined by an Elevation Certificate. Based on the above information, this property is not in a Special Flood Hazard Area.



Edwards, Kretz, Lohr & Associates, Inc.

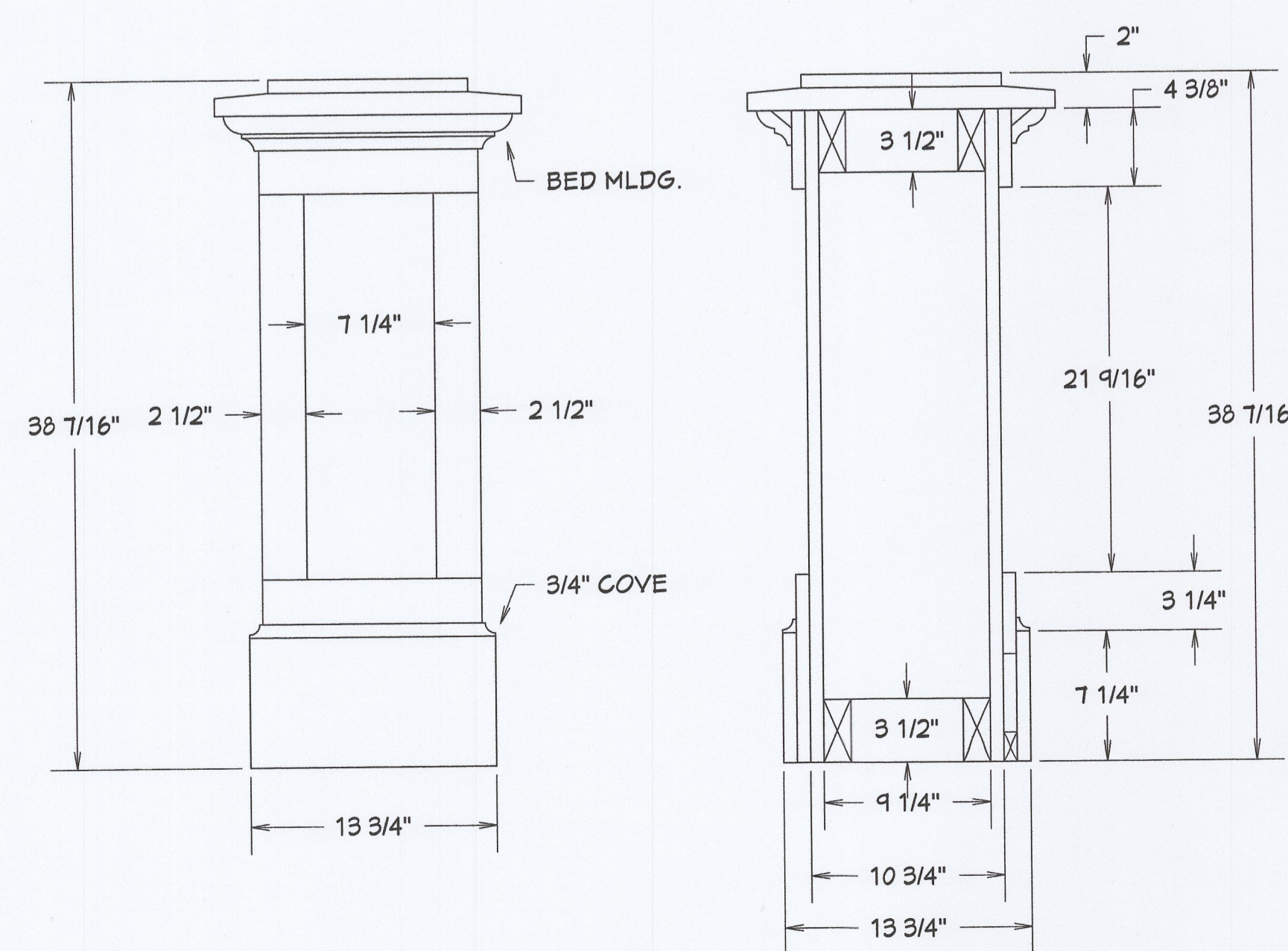
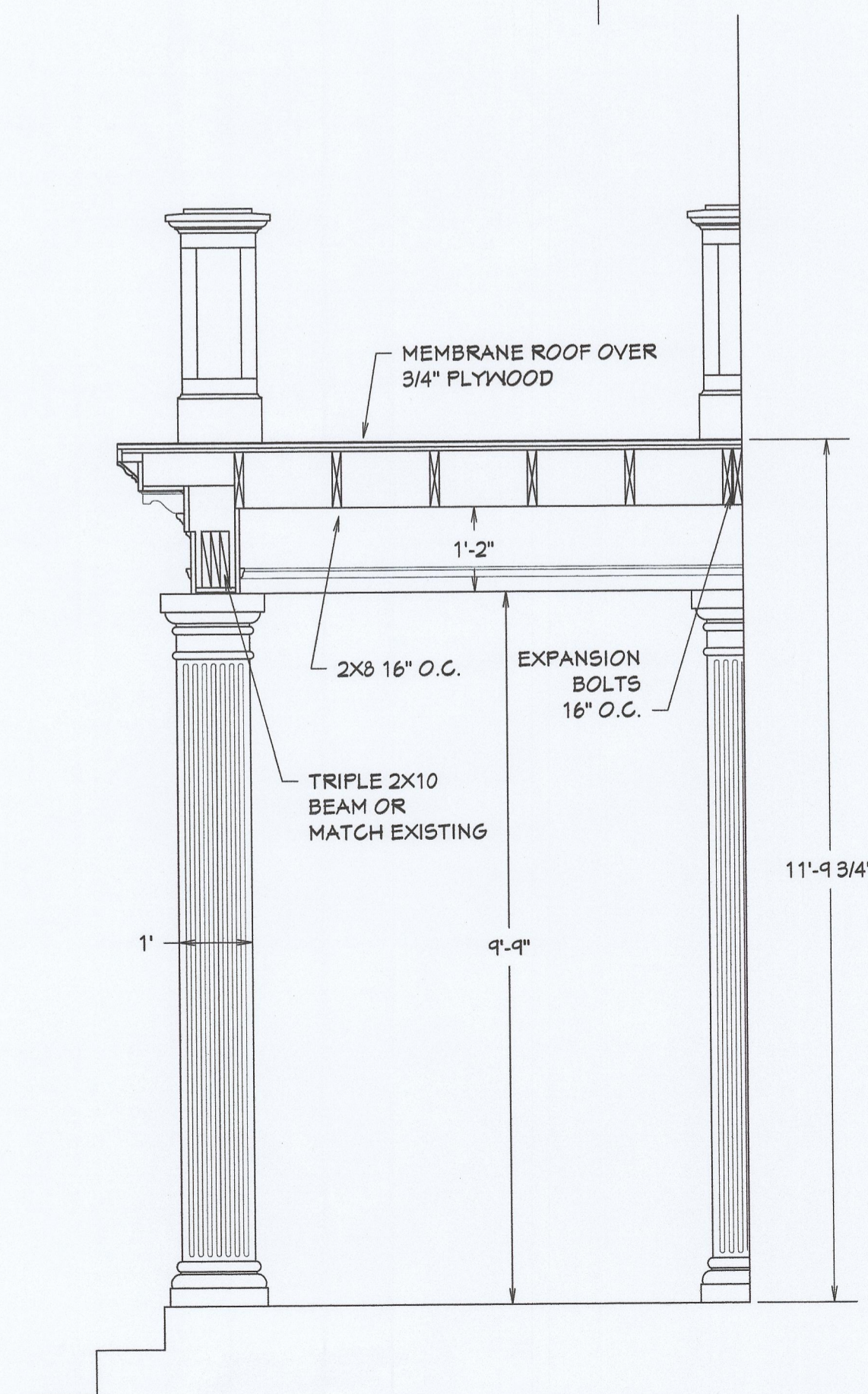
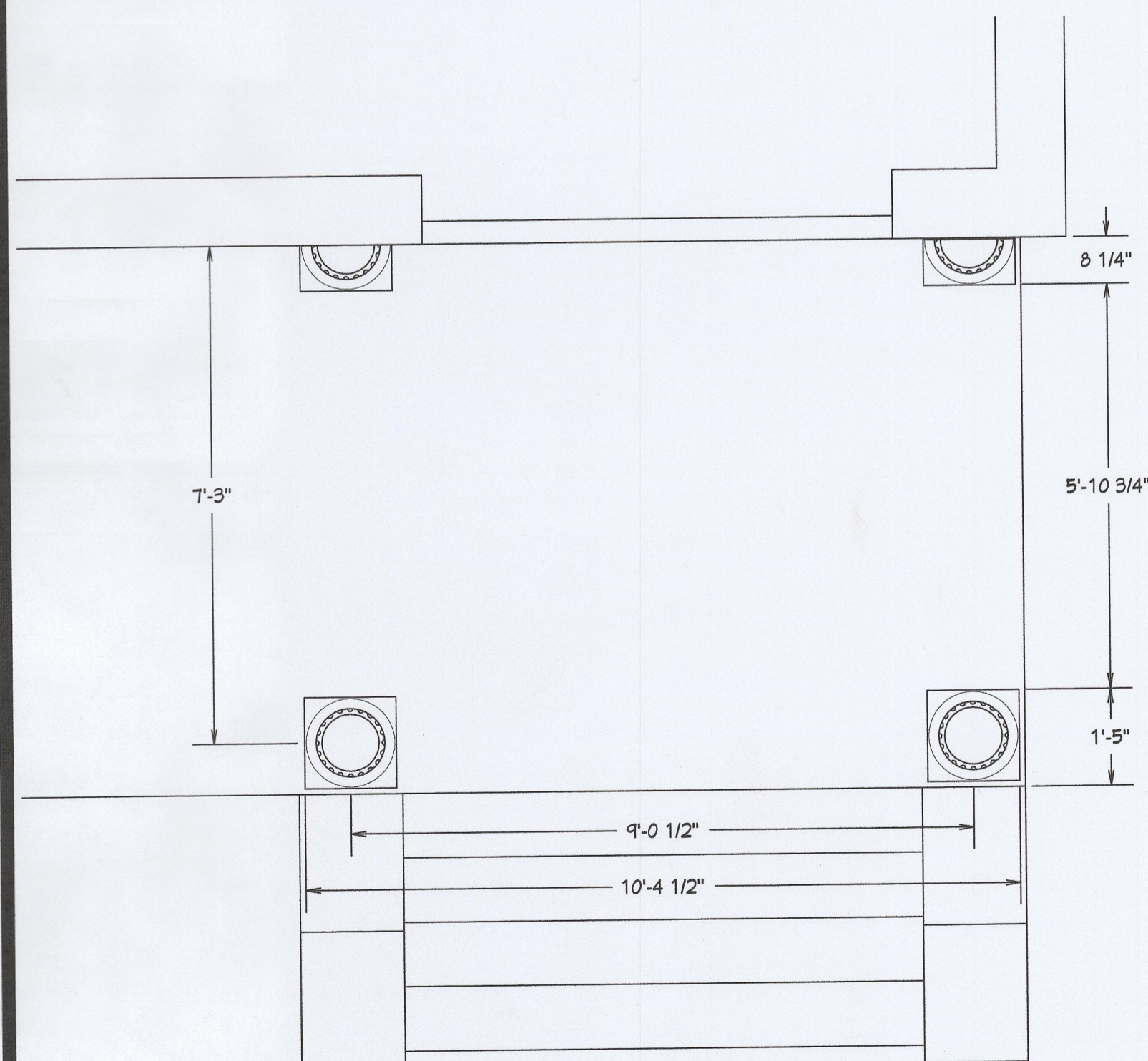
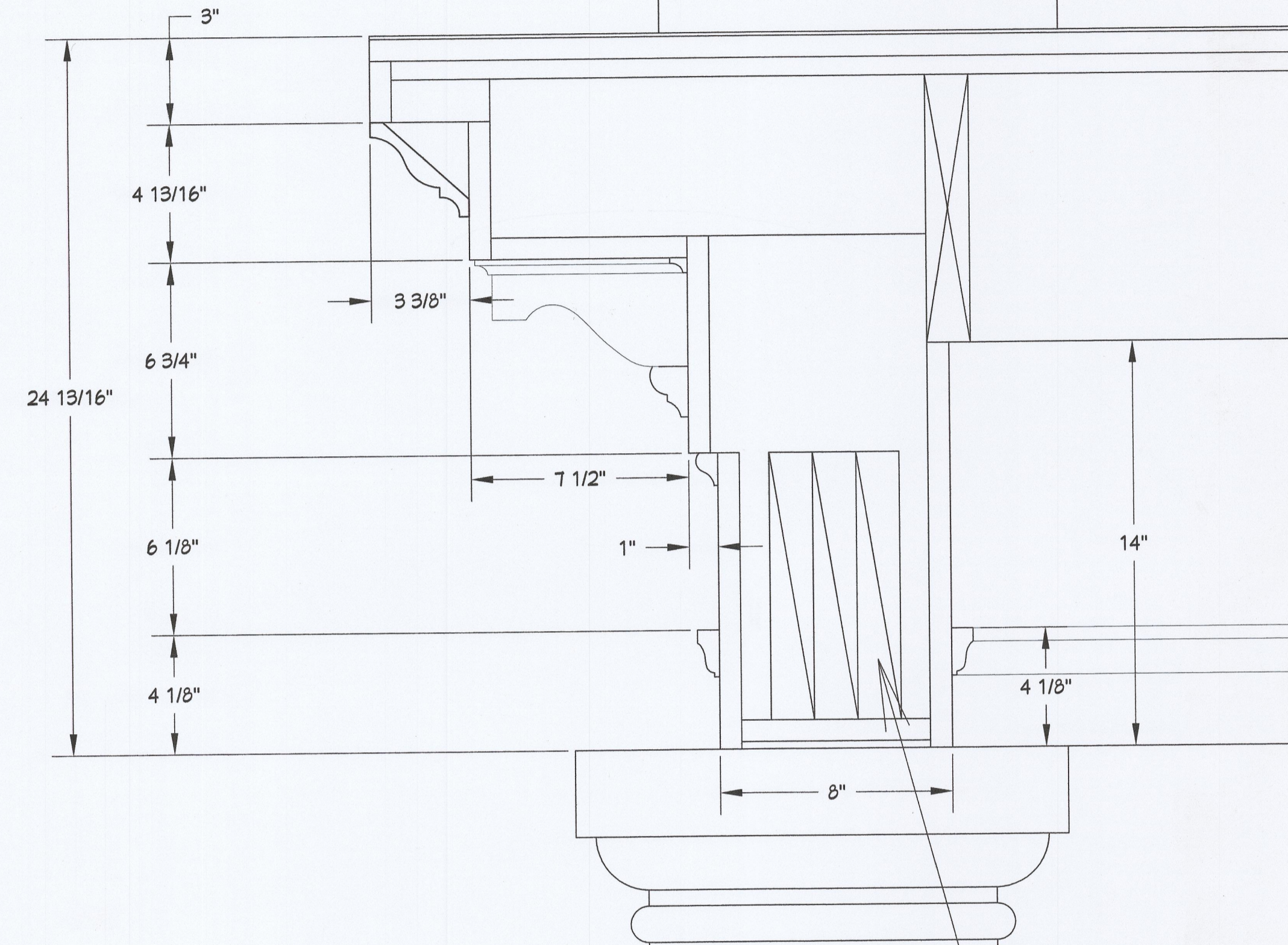
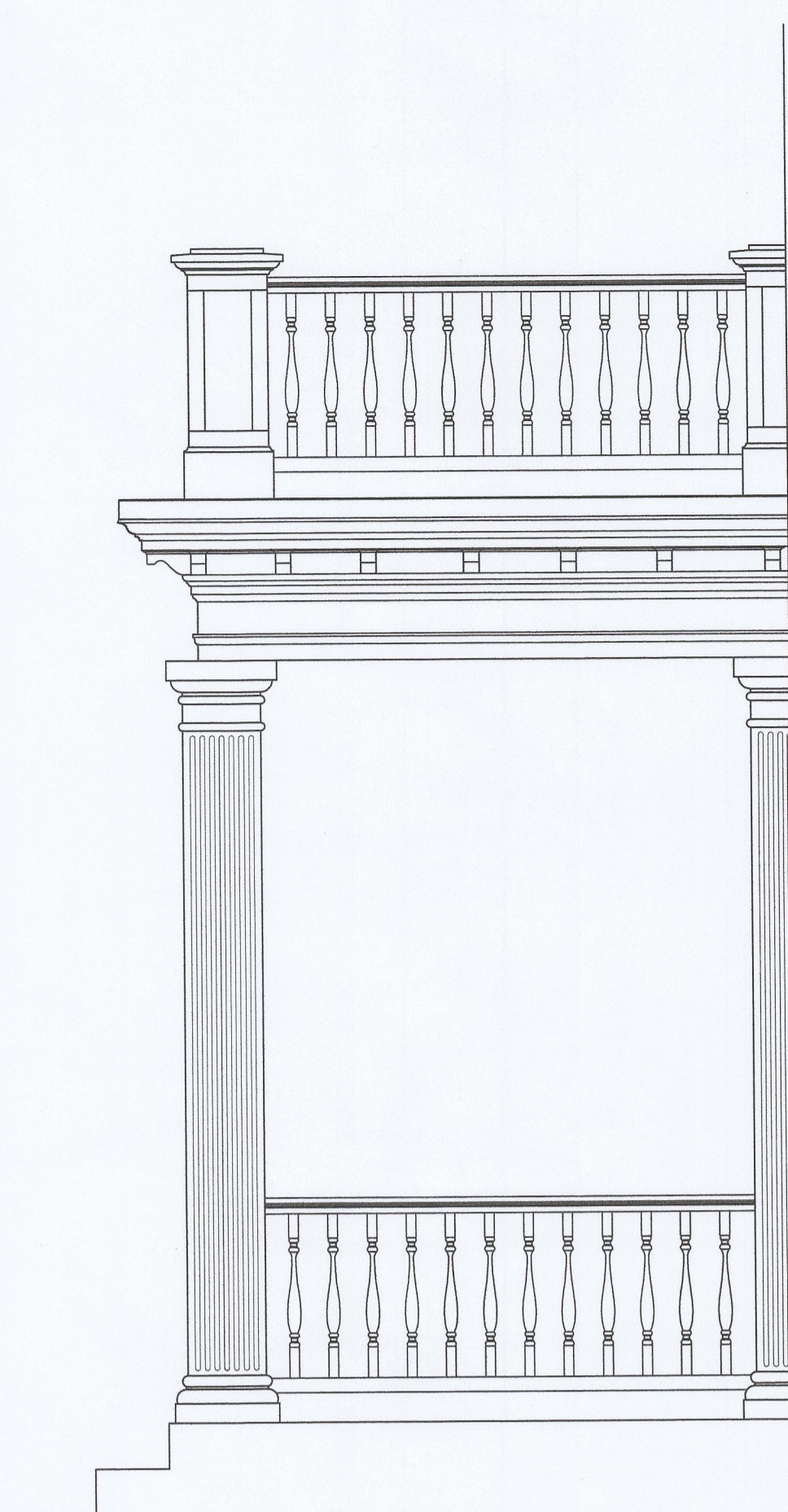
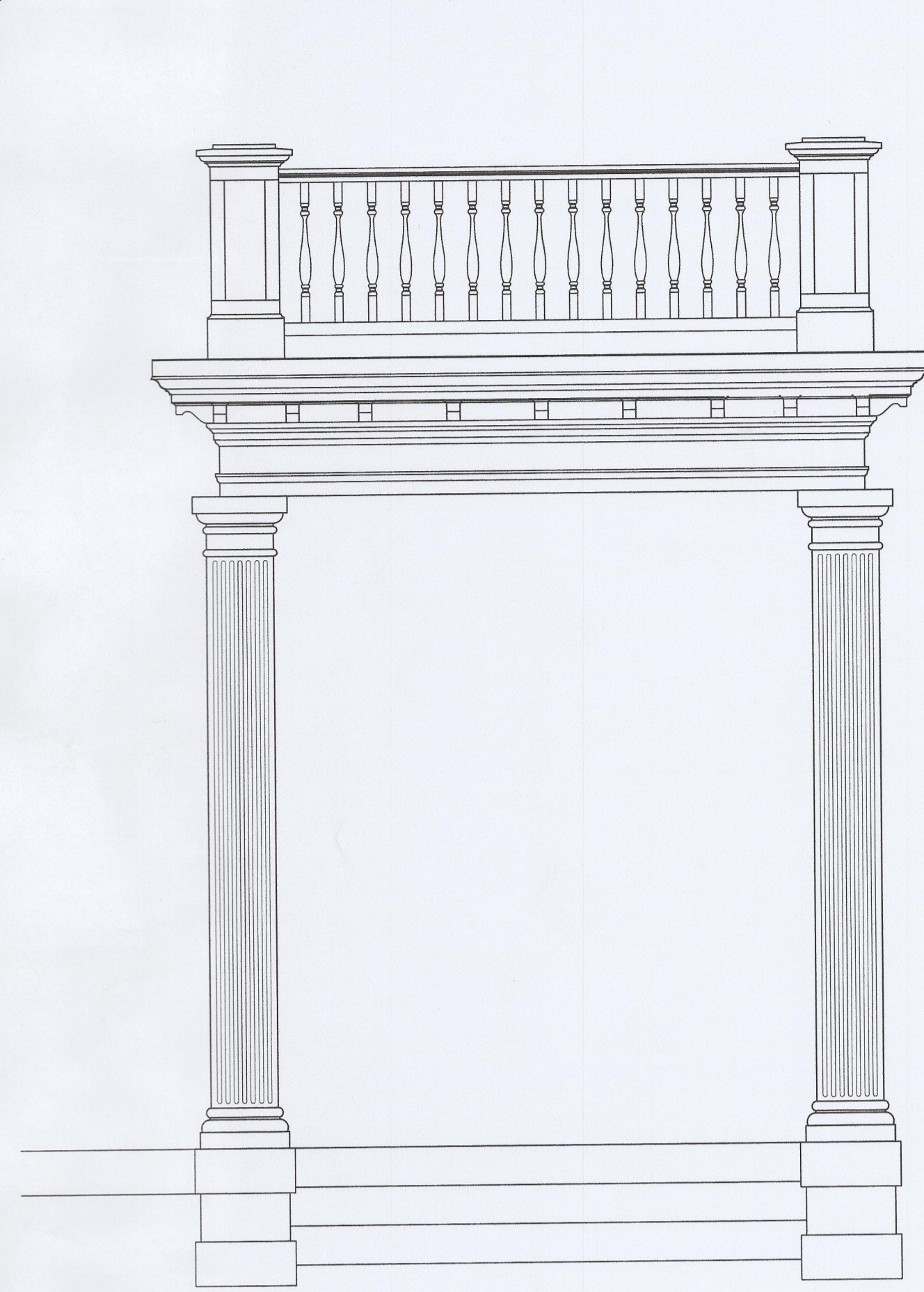

General Notes

No.	Revision/Issue	Date

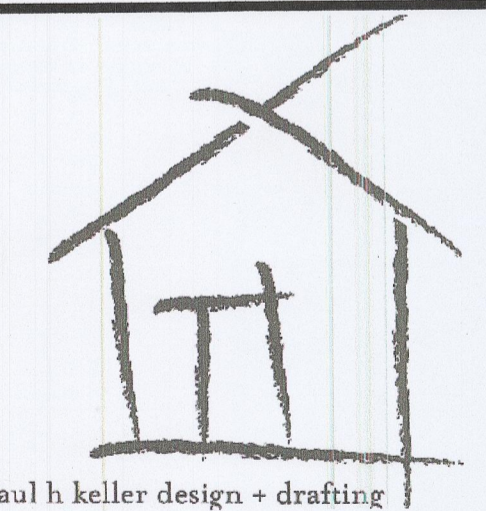

4010 OLD GUN ROAD E. Ph: 804 349-5365
 MIDLOTHIAN, VA 23113 FAX: 804 272-0552

Project Name:	GRACE ST PORCH REPAIRS
Owner:	ECHOL MARSHALL
Address:	2701 W. GRACE STREET RICHMON VA 23220
Phone:	804-398-8209

Drawn by:	PHK	Sheet
Date:	5-9-17	1
Scale:	VARIABLES	

From: [Echol Marshall](#)
To: [Pitts, Marianne G. - PDR](#)
Subject: 2701 W Grace Street porch technical specifications
Date: Thursday, June 08, 2017 2:21:20 PM
Attachments: [permacast.pdf](#)
[permaporch_rails.pdf](#)

Marianne,

I plan on using HB&G products for the porch, and I am attaching PDFs of the technical specifications. See the PDF called "Permaporch". The front page has a 12" column, which is my size, but will be fluted. My handrail will be the "Savannah" design

The posts for the handrail will be 12" x 12" by 40", with recessed panels, Tuscan base and standard flat cap.

The sheet called "permacast" has the specs on the columns. I will order two whole, and two split with the "stock molded flutes". taped column with Tuscan base and cap.

Please let me know if you need any further clarifications. and thank you for all your help. Go Trojans! HPOZ Country club park!

--

Echol Marshall

cell: 804-398-8209

echol.weebly.com

"Education is the ability to listen to almost anything without losing your temper or your self-confidence"

-- Robert Frost

The **PERMA**Cast® Column Collection

- Weather Proof
- Insect Proof
- Load Bearing
- Low Maintenance

- Ready to Prime and Paint
- Limited Lifetime Warranty
- Custom Fluting Available
- Factory PermaPriming Available



24" Round PermaCast® Columns with
Roman Corinthian Capitals

Architectural Accuracy

In the first century B.C., Vitruvius, a Roman architect and engineer, wrote what has become the most influential work on classic form. In it, he elaborates on the discovery by the ancient Greeks of entasis, a gradual tapering of the upper two-thirds of the round column which offsets the undesirable illusion from eye level that the column shaft grows larger as it ascends. HB&G round columns hold true to this classic form.

HB&G PermaCast® Columns are available in round or square. The round columns are fluted, or plain, with or without the classic tapering of the upper two-thirds of the column. Square columns are available in a variety of styles as well, including plain or fluted, applied panel,

recessed panel, or the craftsman style column. The PermaCast® capitals and bases are made from durable low-maintenance materials, and like the columns, they maintain architectural authenticity and historical accuracy.



Round Plain (page 10) Round Fluted (page 10) Round No-Taper (page 11) Square Fluted (page 12) Square Recessed Panel (page 13) Square Applied Panel (page 12) Plain Square (page 12) Craftsman (page 14)



Tuscan Cap (Round)



Tuscan Cap (Square)



Doric Cap (Round)



Colonial Cap (Round)



Attic Base (Round)



Crown Cap or Base



Tuscan Base Poly/Fiberglass (Round)



Tuscan Base (Square)



Doric Base (Round)



Colonial Base (Round)



Attic Base (Square)



PermaTuff™ Tuscan Base



Roman Ionic



Greek Ionic



Temple of the Winds



Roman Corinthian



Scamozzi



Colonial Cap (Square)



Roman Ionic (Square)



Greek Ionic (Square)



Temple of the Winds (Square)



Roman Corinthian (Square)



Scamozzi (Square)



Colonial Base (Square)

See pages 16 and 17 for cap and base dimensions.

Round PERMACast® Columns

ROUND PERMACAST® COLUMN DIMENSIONS (IN INCHES)*

COL. SIZE	A	B	C	D	E	F	G	J	K	L	O	N	R	T	LENGTHS AVAIL. (ft.)
6"	5 3/8"	4 3/8"	9"	1 1/8"	1 1/8"	3/16"	3/4"	1 1/4"	1 3/8"	8"	1"	6 3/4"	3 1/16"	4 7/16"	4,6,8
8"	7 3/8"	6 3/4"	10 1/2"	1 7/8"	1 3/4"	3/4"	3/4"	1 1/4"	1 1/2"	9 3/4"	1/2"	2 1/4"	4 3/8"	4 1/2"	5,6,8,10,12
10"	9 3/8"	8 3/4"	13 3/8"	2 1/8"	2 1/8"	3/4"	3/4"	1 1/4"	1 1/4"	11 1/4"	3/8"	2 1/4"	5 1/4"	5"	6,8,10,12
12"	11 3/8"	9 3/4"	16 1/2"	2 7/8"	2 7/8"	7/8"	1 1/16"	1 1/4"	2 1/4"	13 3/4"	3/4"	2 5/8"	6 3/8"	5 3/4"	6,8,10,12,14,16,18
14"	13 3/8"	11 3/4"	19 1/2"	3 3/8"	3 3/8"	1 1/8"	7/8"	2"	2 1/8"	17"	7/8"	2 5/8"	7 7/8"	7"	8,10,12,14,16,18
16"	15 3/4"	13 3/8"	22 3/8"	4"	3 1/2"	1 1/8"	1"	2 1/4"	3"	19 3/4"	1"	3"	8 3/8"	8"	8,10,12,14,16,18,20
18"	17 1/2"	15 3/8"	24 3/4"	4"	4"	1 1/8"	1 1/8"	2 3/4"	3 3/8"	22 3/8"	1 1/2"	10 3/4"	9 3/8"	8 7/8"	10,12,14,16,18,20,22,24,26
20"	19 1/2"	17 1/16"	27"	4 3/4"	4 1/2"	2"	1 1/16"	2 7/8"	3 3/8"	24 3/16"	1 1/2"	10 3/4"	11 1/4"	9"	10,12,14,16,18,20,22,24
22"	21 3/8"	19 3/4"	30 3/4"	5 3/8"	4 7/8"	2"	1 1/8"	3"	3 3/4"	27 1/2"	1 1/2"	10 3/4"	12 1/4"	10 3/4"	16,18,20,22,24,26
24"	23 3/8"	21 3/4"	33 1/2"	5 7/8"	5 1/4"	2 3/16"	2 3/16"	3 3/2"	4 1/16"	30 1/2"	1 1/2"	10 3/4"	13 3/8"	11 3/8"	12,14,16,18,20,22,24,26,28,30
28"	28"	24 3/4"	38"	6 3/4"	6"	2 3/4"	2 3/4"	3 3/4"	4 3/4"	33 3/8"	1 1/2"	10 3/4"	15 1/2"	11 1/4"	20,22,24,26,28
30"	29 3/8"	26 1/2"	41 1/8"	6 1/2"	5 7/8"	2 1/2"	3 1/16"	4"	4 3/8"	38 3/4"	1 1/2"	10 3/4"	14 7/8"	14 7/8"	20,22,24,26,28,30

*There may be a variance of up to 1/4" in all dimensions. Fluted columns available in all diameters. See page 14 for Parallel dimensions. See page 16 for Ornamental Capital dimensions. Standard Fluted Column (Fluted in mold)

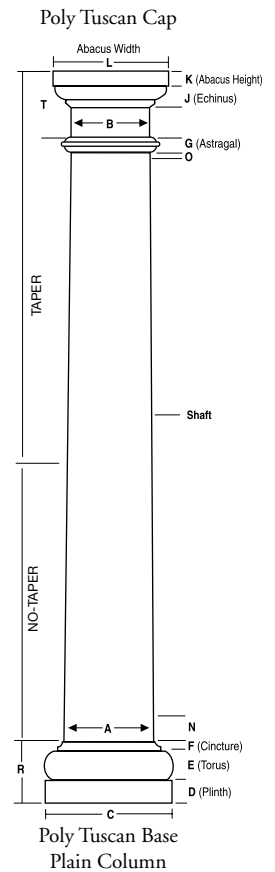

COLUMN-LOC™

Column-Loc™ creates a continuous connection from floor to beam/header without the expense of splitting and reattaching the column. This labor saving product is easy to install and delivers wind uplift resistance especially important in coastal and high wind areas. Currently available for 8 and 10" round (tapered and no-taper) and square PermaCast® columns. Kits are available with and without threaded rod.



ROUND PERMACAST® INSIDE DIMENSIONS

Inside dimension may vary up to 1/8". Splitting a column will decrease inside dimension 1/8".

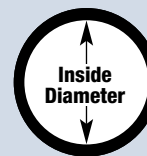

COLUMN SIZE	TOP I.D.	BOT I.D.
6"	3 7/8"	4 3/8"
8"	5 1/2"	6 3/8"
10"	7 3/8"	8 3/8"
12"	8 3/8"	10 3/8"
14"	10 3/8"	12 3/8"
16"	12 3/8"	15"
18"	14 3/8"	16 3/8"
20"	16 3/8"	19"
22"	18 3/4"	20 3/8"
24"	20 3/4"	22 3/8"
28"	22"	26 1/2"
30"	25 1/4"	28 3/8"

PLUMB-FIT®

To make installation even easier our 6-12" round and square poly Tuscan Cap and Base Sets with flashing cap now come with the Plumb-Fit® installation system included.

SPLIT COLUMN ASSEMBLY KITS (FLANGE KIT)

HB&G offers a split column assembly kit that utilizes a mechanical fastening system for easy and secure assembly. This kit can be purchased separately when ordering a factory split column or they can be ordered pre-installed on factory split columns. This kit is available on select sizes.

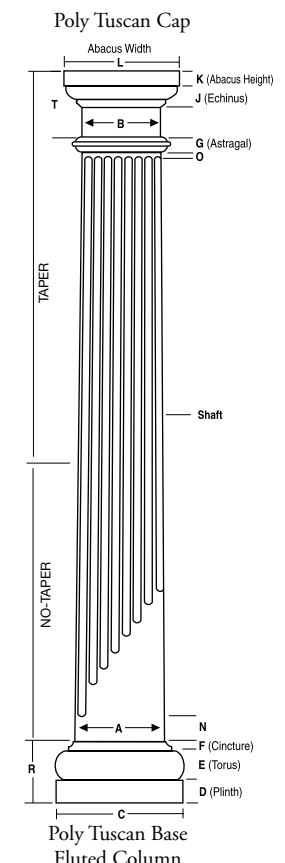

Fluted Round **PERMA**Cast® Columns

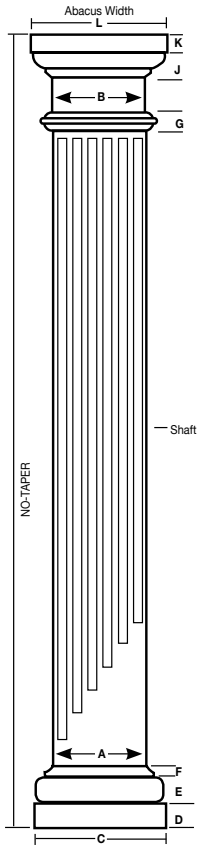

PermaCast® No-Taper column with Poly Tuscan cap and base

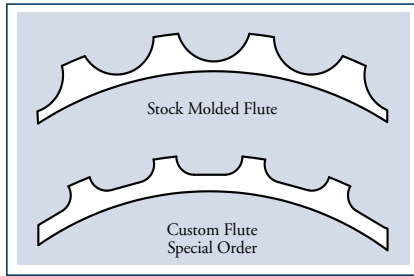

HB&G OFFERS TWO DISTINCTIVE TYPES OF FLUTES.

Stock Molded Flute: Available in diameters of 8" x 8' – 16" x 12' columns (See price guide for specific lengths available.) The stock molded flute is part of the manufacturing process and cannot be altered.

Custom Flute: The custom flute is milled after the column is manufactured and can be modified to your specific length. All round PermaCast® columns, 6" x 4' – 30" x 30', are available with an optional custom flute. (Call a customer service representative for pricing and lead times.) Adjusted Flutes available.



Round No-Taper **PERMA**Cast® Columns

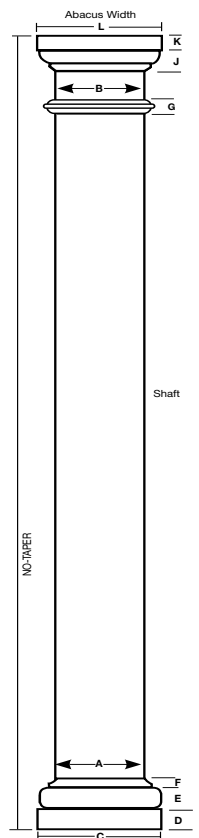

PermaCast® Plain No-Taper column with Poly Tuscan cap and base

ROUND NO-TAPER PERMACAST® COLUMN DIMENSIONS (IN INCHES)

Col. Size	A	B	C	D	E	F	G	J	K	L	Lengths Avail. (ft.)
8"	7 ⁵ / ₈ "	7 ⁵ / ₈ "	10 ¹ / ₂ "	1 ⁷ / ₈ "	1 ³ / ₄ "	3/4"	3/4"	1 ¹ / ₄ "	1 ¹ / ₂ "	10 ⁵ / ₈ "	6,8,9,10
10"	9 ⁵ / ₈ "	9 ⁵ / ₈ "	13 ¹ / ₈ "	2 ³ / ₈ "	2 ¹ / ₈ "	3/4"	3/4"	1 ¹ / ₄ "	1 ³ / ₄ "	12 ¹³ / ₁₆ "	6,8,9,10,12
12"	11 ⁵ / ₈ "	11 ⁵ / ₈ "	16 ¹ / ₂ "	2 ⁷ / ₈ "	2 ³ / ₈ "	7/8"	1 ³ / ₁₆ "	1 ³ / ₄ "	2"	15 ⁷ / ₈ "	6,8,9,10,12
14"	13 ⁵ / ₈ "	13 ⁵ / ₈ "	19 ¹ / ₂ "	3 ³ / ₈ "	3 ¹ / ₈ "	1 ¹ / ₈ "	7/8"	2 ¹ / ₄ "	3"	19 ¹ / ₈ "	6,8,9,10,12,14
16"	15 ³ / ₄ "	15 ³ / ₄ "	22 ¹ / ₈ "	4"	3 ¹ / ₂ "	1 ¹ / ₈ "	1"	2 ¹ / ₄ "	2 ³ / ₄ "	22"	6,8,9,10,12,14,16,18,20
18"	17 ¹ / ₂ "	17 ¹ / ₂ "	24 ³ / ₈ "	4"	4"	1 ⁵ / ₈ "	1 ¹ / ₈ "	2 ³ / ₄ "	3 ¹ / ₈ "	24 ⁵ / ₈ "	6,8,9,10,12,14,16,18,20
24"	24"	24"	33 ¹ / ₂ "	5 ³ / ₄ "	5 ¹ / ₄ "	2 ³ / ₁₆ "	2 ³ / ₁₆ "	3 ¹ / ₂ "	4 ¹ / ₈ "	33 ³ / ₈ "	8,10,12,14,16,18,24

Neck mould not included.
Flashing and Installation Kit not available with No-Taper Tuscan cap and base sets.

NECK MOULD FOR NO-TAPER COLUMN – SOLD SEPARATELY

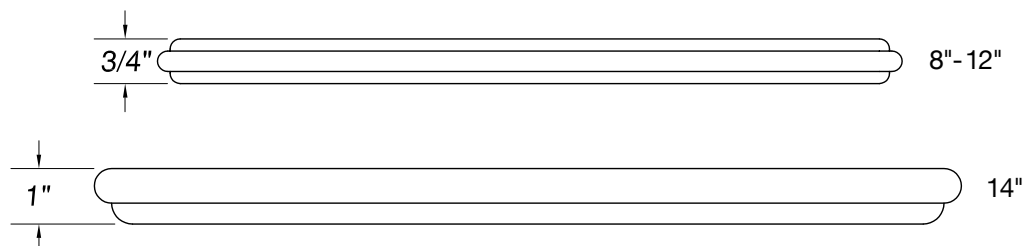

Square **PERMA**Cast® Columns

SQUARE PERMACAST® INSIDE DIMENSIONS

Inside dimensions may vary up to 1/8".
Splitting a column will decrease inside dimension 1/8".

COL. SIZE	INSIDE
6"	5 1/4"*
8"	6 7/8"
10"	9"
12"	11"
14"	12"
16"	14 3/4"

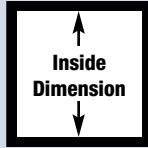

*Inside is Round

PANEL MOULDING FOR SQUARE PERMACAST®

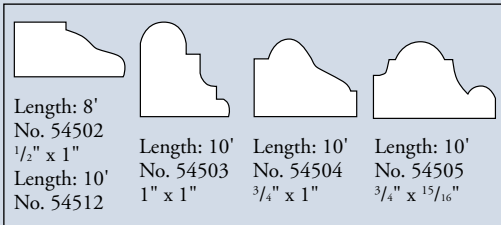

Plumb-Fit®

To make installation even easier our 6-12" round and square poly Tuscan Cap and Base Sets with flashing cap now come with the Plumb-Fit® installation system included.

Column-Loc™

Column-Loc™ creates a continuous connection from floor to beam/header without the expense of splitting and reattaching the column. This labor saving product is easy to install and delivers wind uplift resistance especially important in coastal and high wind areas. Currently available for 8 and 10" round (tapered and no-taper) and square PermaCast® columns. Kits are available with and without threaded rod.

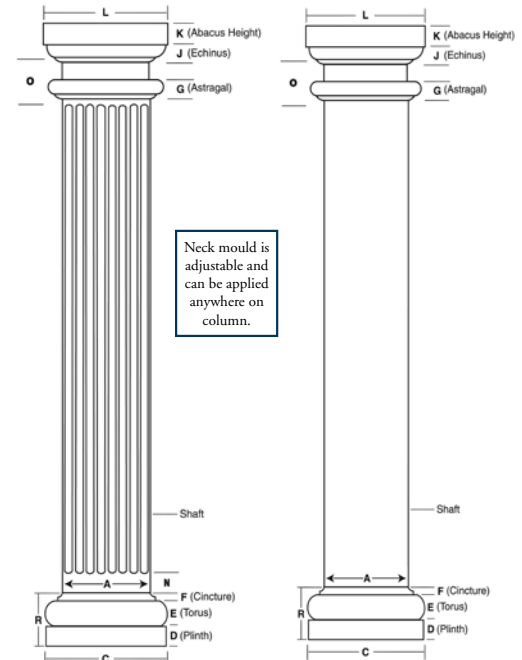

PermaCast® Square Column shown fluted with Poly Tuscan Cap and Base.

PermaCast® Square Column shown plain with Poly Tuscan Cap and Base.

SQUARE PERMACAST® COLUMN DIMENSIONS (In Inches)*

Column Size	A	C	D	E	F	G	J	K	L	N	O	R	Lengths Available (ft.)
6"	6"	9 3/8"	1 1/8"	1 5/8"	5/8"	1"	1 1/4"	1 3/8"	9 3/8"	N/A	N/A	3 3/8"	6,8,9,10
8"	8"	11 1/8"	1 7/8"	1 3/4"	5/8"	1"	1 3/8"	1 3/8"	10 15/16"	4"	3 1/8"	4 1/4"	6,8,9,10,12
10"	10"	13 3/8"	2 1/4"	2 3/8"	3/4"	1"	1 1/4"	1 13/16"	12 3/4"	4"	4 1/8"	5 3/8"	51",6,8,9,10,12,14,16
12"	12"	16 3/8"	2 13/16"	2 3/8"	7/8"	1"	1 3/4"	2 1/8"	16 11/16"	N/A	N/A	6 3/8"	8,9,10,12,14,16,18
14"	14"	19 3/8"	3 1/8"	2 7/8"	1 1/16"	1 1/8"	2 1/16"	2 1/2"	19 1/16"	N/A	N/A	7 9/16"	8,10,12
16"	16"	22 1/8"	3 7/8"	3 3/8"	1 1/8"	1 1/8"	2 3/8"	2 3/4"	21 1/2"	N/A	N/A	8 3/8"	8,10,12,14,16,18,20

☐ Fluted Square.

*There may be a variance of up to 1/4" in all dimensions.
See page 16 for Ornamental Capital dimensions.

Versatility of Square Columns

The design and versatility of an HB&G square column has enhanced its popularity with today's architects. The HB&G Square PermaCast® column lineup includes plain, recessed panel, and fluted styles. An unlimited combination of styles can be achieved by various uses of the panel moulding, neck moulding, and caps and bases. Additionally, the square column is not tapered and can be cut to any height without affecting the fit of the caps and bases.

Recessed Panel **PERMA**Cast® Columns

RECESSED PANEL INSIDE DIMENSION

Inside dimension may vary up to 1/8".
Splitting a column will decrease inside dimension 1/8".

Col. Size	Inside
8"	5-5/8"
10"	7-1/2"
12"	9-1/2"
14"	11"

↑
**Inside
Dimension**
↓

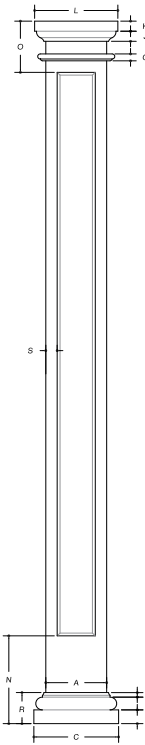

Neck mould is adjustable and can be applied anywhere on column.

Square Column with Poly Tuscan Cap and Base

SQUARE RECESSED PANEL PERMACAST® COLUMN DIMENSIONS (In Inches)*

Column Size	A	C	D	E	F	G	J	K	L	N	O	R	S	Recess Depth	Lengths Available (ft.)
8"	8"	11 1/8"	1 7/8"	1 3/4"	5/8"	1"	1 3/8"	1 3/8"	10 15/16"	12"	7"	4 1/4"	1 1/2"	1/2"	8,9,10
10"	10"	13 1/16"	2 1/4"	2 3/16"	3/4"	1 1/4"	1 1/4"	1 13/16"	12 3/4"	14 1/2"	8 1/2"	5 3/16"	1 1/2"	1/2"	8,9,10
12"	12"	16 9/16"	2 13/16"	2 3/8"	7/8"	1 1/4"	1 1/4"	2 1/16"	16 11/16"	18"	10 1/2"	6 1/16"	2 1/4"	3/16"	8,9,10,12,14
14"	14"	19 3/8"	3 5/8"	2 7/8"	1 1/16"	1 1/8"	2 1/16"	2 1/2"	19 1/16"	21"	12 1/4"	7 9/16"	2 3/8"	3/4"	8,10,14

See page 16 for Ornamental Capital dimensions.

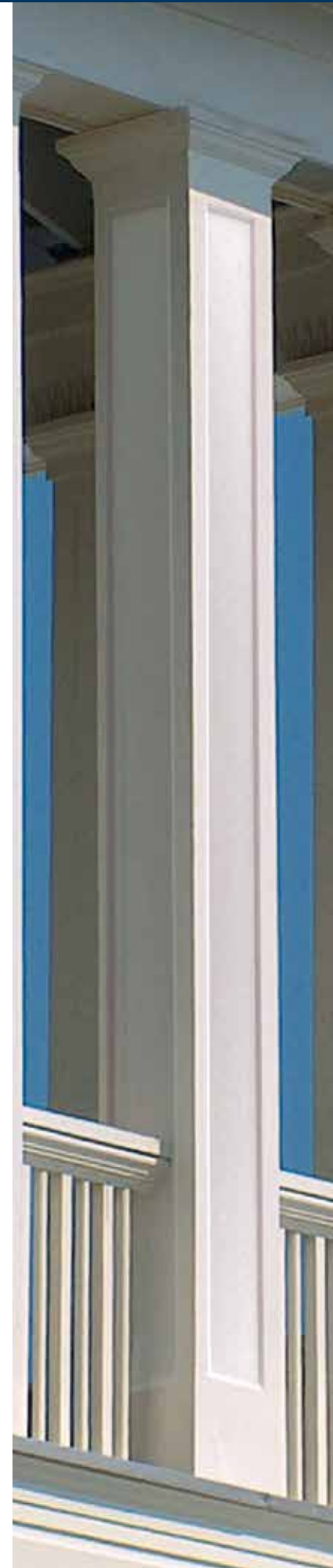

CRAFTSMAN

PERMACAST® COLUMN

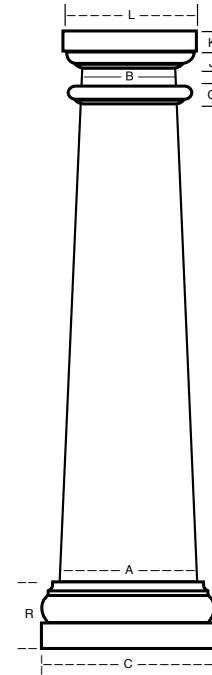

Neck mould is adjustable and can be applied anywhere on column.*



CRAFTSMAN INSIDE DIMENSION

Inside dimension may vary up to 1/8".
Splitting a column will decrease inside dimension 1/8".

Column Size	Top	Bottom
10" x 5 1/2"	4 1/2"	9"
10 1/4" x 7 1/2"	6 1/2"	9 1/4"
10" x 8"	6 1/2"	8 1/2"
12" x 10"	9"	11"
14" x 12"	11"	13"
16" x 9"	8"	15"
16" x 12"	10 1/2"	14 1/2"

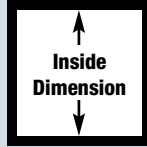

CRAFTSMAN COLUMN DIMENSIONS (IN INCHES)

	A	B	C	D	E	F	G	J	K	L	R	LENGTH
10" x 5 1/2"	10"	5 1/2"	13"	2 1/2"	2 3/8"	1 1/16"	1"	1 3/8"	1 3/8"	9 5/8"	5 7/8"	66"
10 1/4" x 7 1/2"	10 1/4"	7 1/2"	13 1/2"	2 3/8"	2 1/4"	3/4"	1"	1"	1"	10 1/4"	5 3/8"	7'
10" x 8"	9 1/2"	7 1/2"	12 3/4"	2 3/8"	2 1/8"	3/4"	1"	1"	1 3/8"	10 1/4"	5 1/4"	66"
12" x 10"	12"	10"	16 9/16"	2 1/2"	2 1/2"	1 1/16"	1"	1 3/8"	1 3/8"	12 3/4"	6 1/16"	6', 10'
14" x 12"*	14"	12"	18 3/4"	3 3/8"	3"	1"	1"	1 5/8"	2"	17 1/8"	7 3/8"	9'
16" x 9"	16"	9"	18 3/4"	2 1/2"	2 1/2"	1 1/16"	1"	1 3/8"	1 3/8"	13 1/4"	6 1/16"	58"
16" x 9"	16"	9"	19 1/16"	2 1/2"	2 1/2"	1 1/16"	1"	1 3/8"	1 3/8"	13 1/4"	6 1/16"	6', 8"
16" x 12"	15 1/4"	11 1/2"	21 1/2"	3 7/8"	3 5/16"	1 3/16"	1"	1 3/8"	2"	15 1/4"	8 7/16"	58", 6', 8'

*Has 1/3" to 2/3" taper.

NOTE: Neck mould is not applied. Flashing and Installation Kit is not available for Craftsman Columns with Poly Tuscan cap and base sets.



Painting Instructions

Painting instructions for round and square PermaCast® columns:

- Rinse and allow to dry completely.
- Prime with high quality exterior latex primer or use an oil-based primer in accordance with paint manufacturer's instructions. A light coat of primer should be applied and allowed to cure fully.
- Paint evenly with several light coats over column with a high quality exterior latex or oil-based (if primer is used) paint in accordance with paint manufacturer's instructions.
- Do not paint PermaCast® columns using dark colors (dark colors are considered any color that falls within the L value of 56 to 0). L is a measure of lightness of an object and ranges from 0 (black) to 100 (white).

Tips

- ✓ When ordering an ornamental capital order the appropriate base for the column.
- ✓ Ornamental capitals for square PermaCast® slide over the shaft and do not use a plug. These ornamental capitals will not lengthen or shorten the height of the column.
- ✓ When installing an ornamental capital on fluted, recessed panel, or square columns, the capital slides over the shaft. The taller capitals will cover the flutes and require additional caulking to finish.
- ✓ Verify exact opening measurement prior to ordering column length.
- ✓ When installing a PermaCast® column, verify concentric loading of column. 100% of bottom must contact substrate and 75% of top must contact soffit.
- ✓ When attaching hand rails or corner iron to PermaCast® columns, holes must be pre-drilled before applying screws.
- ✓ When ordering panel moulding for square PermaCast® columns, make sure to order enough for four sides of the column.
- ✓ Split columns are left partially intact. Cut with masonry or carbide tip blade.
- ✓ Custom split columns, caps, and bases are nonrefundable.

Splitting Options

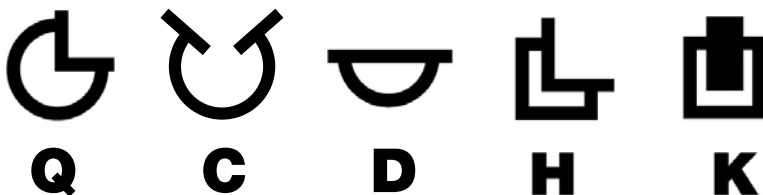

HB&G's number one goal is finding ways that we can save you time and make your life easier.

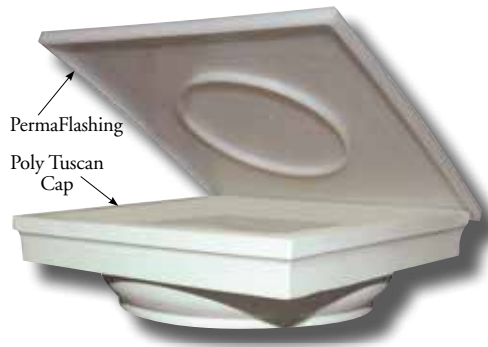

PermaCast® PermaFlashing and Installation Kit

The PermaCast® flashing with Plumb-Fit® and installation kit is available in selected Tuscan cap and base sets.*

This innovation will not only save time but will keep the elements out of the column and secure the top and bottom of the column.

*Not available in Tuscan cap and base sets for Craftsman, No-taper, PermaLite®, and Wood columns.



Round PermaCast® Porch Installation Bracket

The HB&G Porch Installation Bracket includes the bracket and all required hardware. The bracket fits 20" - 30" Plain Round PermaCast® Columns and will secure a 2nd story porch to our PermaCast® Columns. Three brackets are required for each column.



PARALLEL DIMENSIONS

Column Size	Parallel Dim.	Column Size	Parallel Dim.
6x4	0"	18x18	60"
6x6	8"	18x20	84"
6x8	32"	18x22	49"
8x5	12"	18x24	73"
8x6	24"	18x26	97"
8x8	32"	20x10	0"
8x9	28"	20x12	0"
8x10	40"	20x14	0"
10x6	8"	20x16	4"
10x8	32"	20x18	28"
10x9	28"	20x20	52"
10x10	40"	20x22	76"
10x12	48"	20x24	100"
12x6	8"	22x16	45"
12x8	32"	22x18	69"
12x9	8"	22x20	93"
12x10	32"	22x22	53"
12x12	48"	22x24	77"
12x14	59"	22x26	101"
12x16	40"	24x12	21"
12x18	73"	24x14	45"
14x8	32"	24x16	69"
14x9	12"	24x18	93"
14x10	24"	24x20	75"
14x12	48"	24x22	99"
14x14	27"	24x24	123"
14x16	51"	24x26	77"
14x18	75"	24x28	101"
16x8	16"	24x30	125"
16x10	40"	28x20	20"
16x12	29"	28x22	44"
16x14	53"	28x24	68"
16x16	36"	28x26	92"
16x18	60"	28x28	116"
16x20	84"	30x20	56"
18x8	0"	30x22	80"
18x10	16"	30x24	140"
18x12	40"	30x26	75"
18x14	48"	30x28	99"
18x16	36"	30x30	123"

Column Size	Bottom Diameter
6x4	5 ³ / ₈ "
18x8	17 ¹ / ₄ "
20x10	18 ¹¹ / ₁₆ "
20x12	18 ⁵ / ₁₆ "
20x14	19 ¹ / ₄ "

The PermaPorch® Railing Collection

- Low Maintenance
- Pre-finished or can be painted
- Easy Installation
- As Versatile as Treated Lumber

- Available in Pre-Built Sections
- Deck Options Available
- 10/25 Year Limited Warranty
- Complete Kits Available
- Ready to Install



12" Round PermaCast® Column with Savannah PermaPorch® Railing

The PermaPorch® Railing system is a beautiful way to tie your whole porch look together. It is made up of several different components, allowing you the ability to create the designs that match your way of life. Easy to install, this

worry free railing system will be a beautiful, low maintenance addition to your porch or deck for generations to come. Be sure to use the coastal newel in areas where coastal effect corrosion is a concern.

Porch Railing

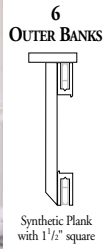
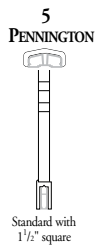
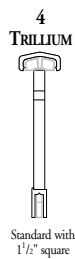
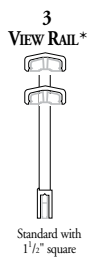
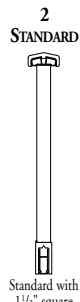
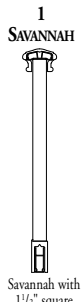

Deck Railing

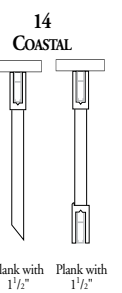
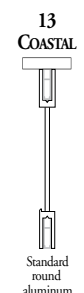
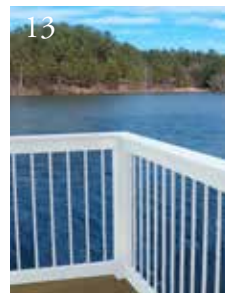
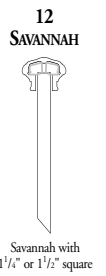
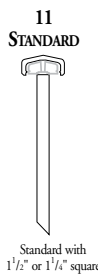
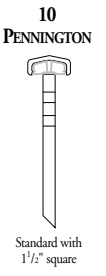
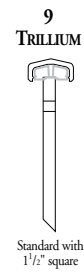
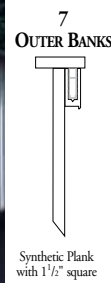

All rail sections suitable with columns (as shown) or PermaPost®
 * Top Rail Section must be installed on site.

Pre-Built PermaPorch® Railing

Pre-Built PermaPorch® Railing is available in a variety of styles to match your porch and deck design. The top and bottom rails are made of pre-finished weather resistant cellular PVC with aluminum inserts.

• HB&G recommends checking all building codes before the design and installation of your PermaPorch® Railing.



The top rail, bottom rail, and balusters are available in pre-finished white. They are made from weather resistant cellular PVC. The balusters are also available in round aluminum.

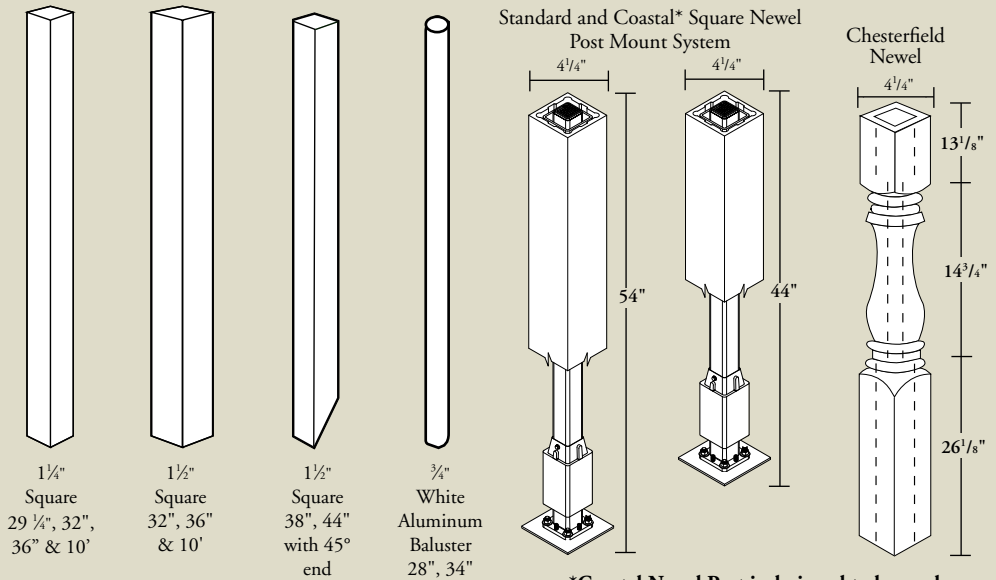
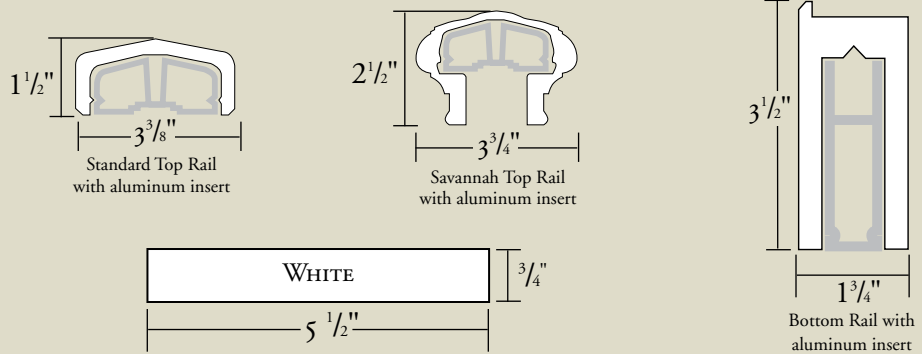

*Coastal Newel Post is designed to be used in harsh and coastal conditions.

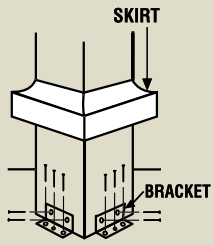

CHESTERFIELD FASTENING KIT*

Each kit comes complete with skirt, brackets, and TapCon screws for wood or concrete substrates.

*Review building code requirements prior to use.



Poly Ball Top
Height 6"
Width at Base 4 7/8"

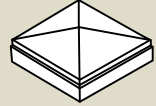

Poly Pyramid Top
Height 1 1/4"
Width at Base 4 7/8"

CUSTOM RAIL PANELS

Custom rail panels are available. Use our custom rail patterns to create a beautiful, one of a kind look that will set any home apart. HB&G's rail panels are designed to work with the PermaPorch® Railing top and bottom rails. They are made of cellular PVC and can be manufactured using your design or you can choose from one of the styles below. Contact a customer service representative now to order your custom rail panel.

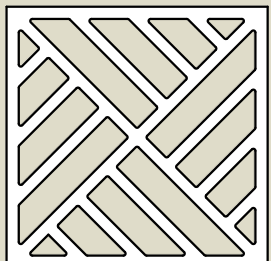

Chippendale

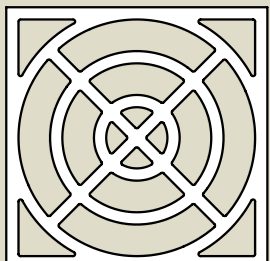

Circle Center

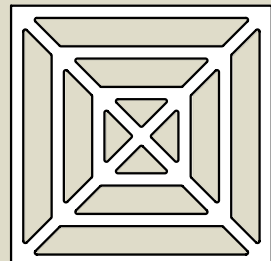

Spiderweb

Savannah PermaPorch® Railing and 5" Square PermaPost®

Three Ways to Order the PermaPorch® Railing...

1. PRE-BUILT SECTIONS

- Shipped factory assembled
- Easy to install
- Everything needed to install is included
- How to order
 - Choose length – 4', 6', or 8' sections
 - Choose desired style from page 33 and 34
 - Note rail height (36" or 42")
- Onsite trimming ensures exact fit

2. DO-IT-YOURSELF KIT

- Rail Section shipped in one box
- Balusters are included in box*
- Everything needed to assemble and install is included
- How to order:
 - Choose length – 6' or 8'
 - Choose style – Savannah or Standard
- Kit includes:
 - Savannah or Standard top rail
 - Bottom rail
 - Aluminum inserts
 - 1 1/2" x 29 1/4" square balusters
 - 8' = 18 balusters
 - 6' = 14 balusters
 - Assembly and installation hardware
 - Support block
- Available in 36" rail height only

*Screws for balusters are not included

3. INDIVIDUAL COMPONENTS

- Build your own design
- Mix and match components
- For a complete rail system you will need the following:
 - Top rail – Standard or Savannah
 - Top insert – aluminum 8', 10', 12'
 - Balusters – 29 1/4", 32", 36", and 10' (Balusters may need to be trimmed for desired rail height.)
 - Bottom rail
 - Bottom insert – aluminum 8', 10', 12'
 - Support block
 - Fastening kit

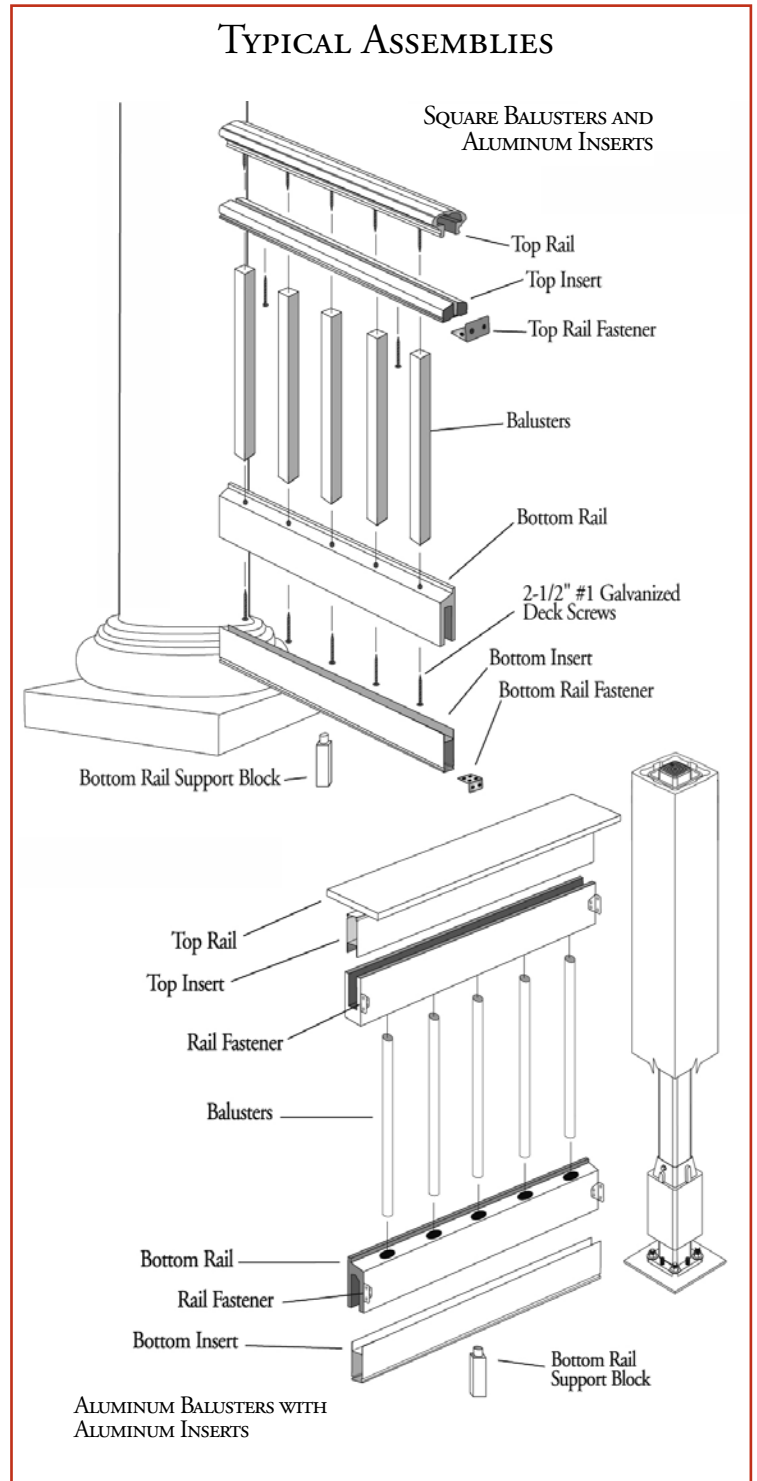

CURVED PERMAPORCH® RAILING

HB&G has a wide range of PermaPorch® Railing styles and designs. With the curved PermaPorch® Railing, HB&G's line of rail products can meet the needs of any application. The curved PermaPorch® Railing is available with either the Standard or Savannah top rail with wood inserts. Radius from 60" to 240" are available in 8 foot sections. Balusters sold separately. For lead time and ordering info, call 1-800-264-4HBG (4424).

HB&G recommends checking all building codes before the design and installation of your PermaPorch® railing.

